

# Wireless World

June 1968

Three Shillings

**W.W. colour receiver**

**Stereo loudness control**



**NOW** Keyswitch is proud to announce five new miniature relays that cleanly sweep the field. British designed, British developed, and British made, the KMK range features high contact capacity, moulded assembly for high insulation, phosphor bronze contact springs, 99.9% silver or silver cadmium oxide contacts, Swedish iron magnetic circuit, international contact clearance of 4mm, life in excess of 5 million operations, connection by solder or push-on type '110' connectors, open relays mounting in any position, and plug-in relays for international plugability. Unit prices are as low as 9/4d (1,000 rate), substantially less for larger quantities.

**5 BRITISH** These versatile new midgets are available with one, two or three changeover contacts rated up to 10A at 250Vac/6Vdc, and with coils for 6-230Vac/2.5VA and for 6-200Vdc/1W. Contact

**MIDGETS** assembly for high insulation, phosphor bronze contact springs, 99.9% silver or silver cadmium oxide contacts, Swedish iron magnetic circuit, international contact clearance of 4mm, life in excess of 5 million operations, connection by solder or push-on type '110' connectors, open relays mounting in any position, and plug-in relays for international plugability. Unit prices are as low as 9/4d (1,000 rate), substantially less for larger quantities.

**MAKE** of 4mm, life in excess of 5 million operations, connection by solder or push-on type '110' connectors, open relays mounting in any position, and plug-in relays for international plugability. Unit prices are as low as 9/4d (1,000 rate), substantially less for larger quantities.

**& BREAK** position, and plug-in relays for international plugability. Unit prices are as low as 9/4d (1,000 rate), substantially less for larger quantities.

**1968's** These versatile new midgets are available with one, two or three changeover contacts rated up to 10A at 250Vac/6Vdc, and with coils for 6-230Vac/2.5VA and for 6-200Vdc/1W. Contact

**BIGGEST** changeover contacts rated up to 10A at 250Vac/6Vdc, and with coils for 6-230Vac/2.5VA and for 6-200Vdc/1W. Contact

**RELAYS NEWS** Keyswitch for complete price and technical details of these exciting new all-British KMK's.

Keyswitch Relays Ltd, Cricklewood Lane,  
London NW2; telephone: 01-452 3344;  
telex: 262754.

**KEYSWITCH RELAYS**



KEYSWITCH RELAYS - WHERE THE ACTION IS - KEYSWITCH RELAYS

When is an Avo meter  
not an Avometer?

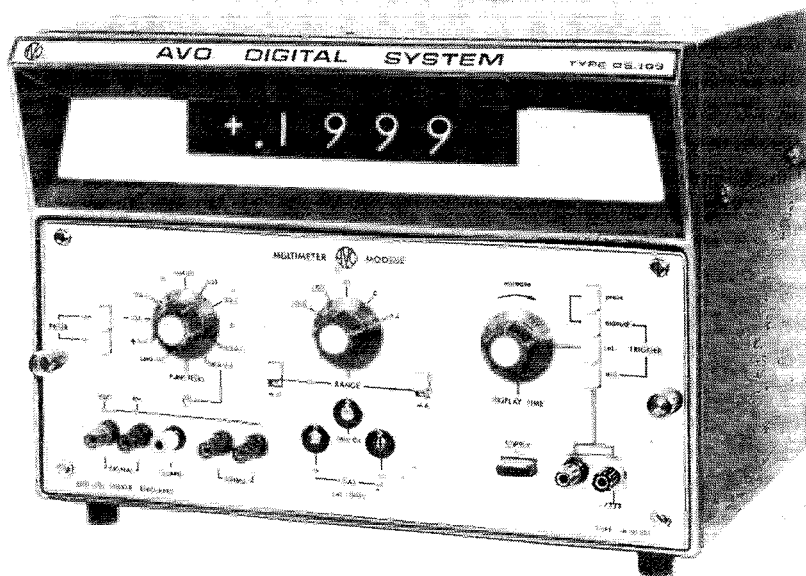

**When  
it's an  
Avo  
Digital  
System**

That's new! Yes, and it has full multimeter and print-out facilities and other plug-in capabilities.

**Please write for full specs.**



**Avo Limited**

Avocet House · Dover · Kent Telephone Dover 2626 Telex 96283

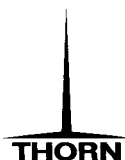

**AVΩ MEANS BASIC MEASUREMENTS ALL OVER THE WORLD**

**WW-005 FOR FURTHER DETAILS**

# what has changed?

Well, loudspeakers for one thing. Practically all loudspeakers designed in the last few years have (rightly) followed the trend towards lower efficiency and therefore require more power to drive them.

And pickups, too. The trend here is towards smaller and lighter moving parts producing lower outputs, requiring greater sensitivity and improved signal to noise ratio in the pre-amplifier.

QUAD has changed to accommodate both, and has also taken the opportunity of introducing other significant improvements in performance and facilities.

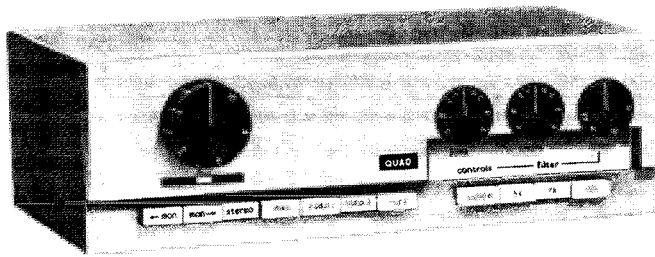

QUAD 33

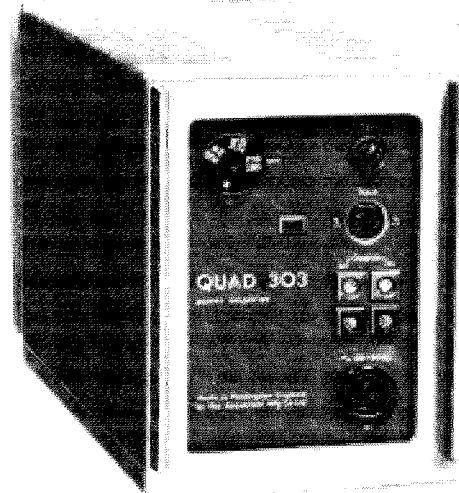

QUAD 303

# QUAD

for the closest approach to the original sound

Complete the coupon below and post today for full details of the new QUAD

Please send me a copy of the new QUAD leaflet

NAME

(Block Capitals)

ADDRESS

(Block Capitals)

**ACOUSTICAL MANUFACTURING COMPANY LTD.,**

Huntingdon. Telephone Huntingdon (0480) 2561/2

ww

WW—006 FOR FURTHER DETAILS

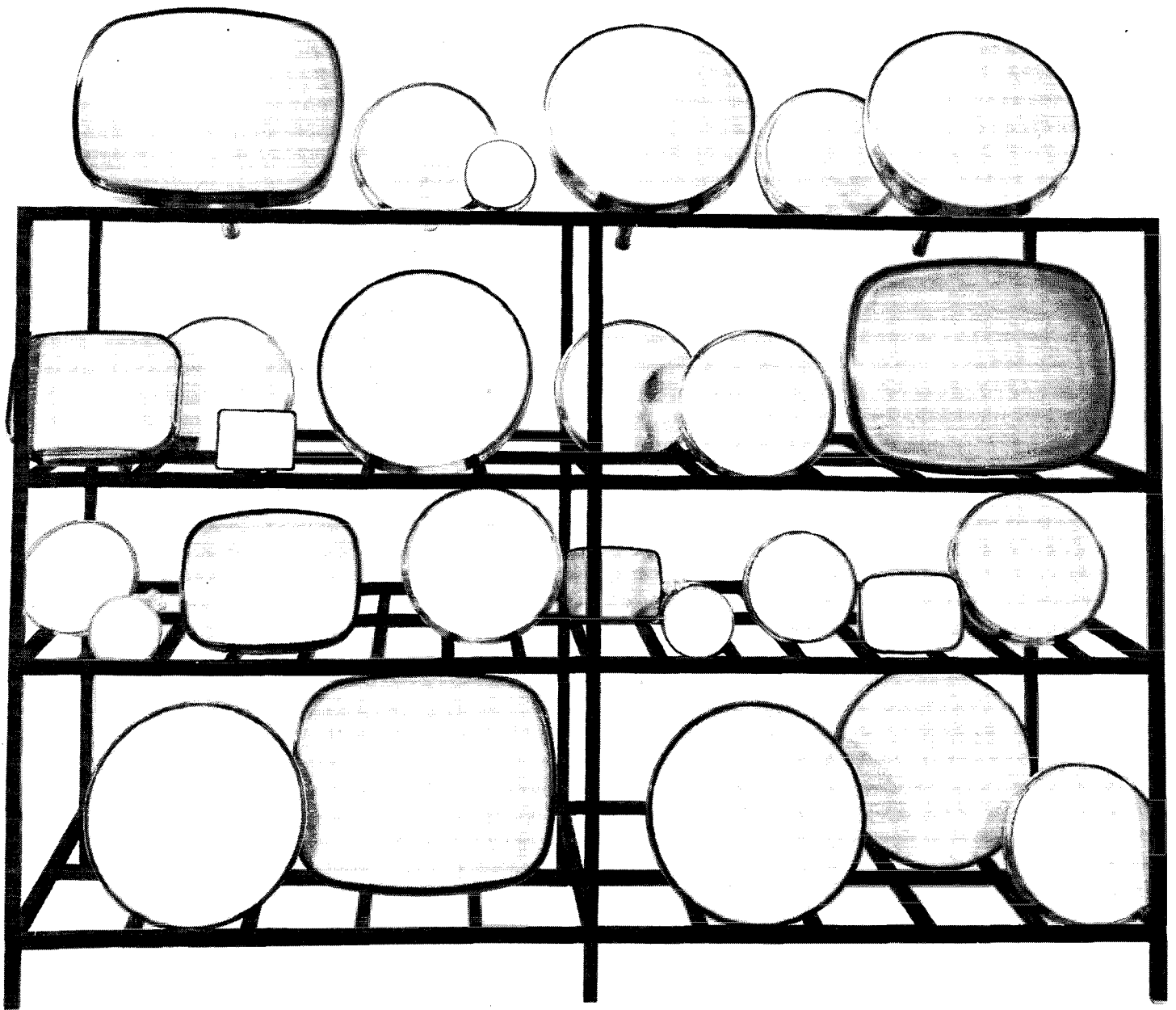

## CRTs off the shelf

(Specials take a little longer)

EEV is probably the best source of specialised CRTs. The standard range is wide and deliveries 'off the shelf'. 'Specials' take a little (but not much!) longer. Use this service in CRTs. It's the most flexible on hand.

**ENGLISH ELECTRIC VALVE COMPANY LIMITED**

WW—007 FOR FURTHER DETAILS

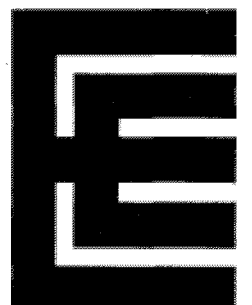
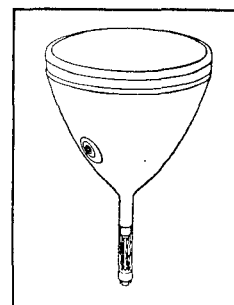

CHELMSFORD, ESSEX. TELEPHONE: 61777

AF300

# NEW FROM **AMPLIVOX**



**'Astrolite'**  
-the  
elegant  
design  
which  
sounds  
as  
good  
as it  
looks.

Here's Headset progress.  
'Astrolite' combines all that's  
good in performance with  
reliability and a world beating design.  
Light in weight (6.5oz approx). New  
high level phones (1 mW gives comfortable  
listening level). Partial noise exclusion.  
Communications or high fidelity versions - magnetic,  
carbon or moving coil. 'Personal tension adjustment'  
gives fingertip control of microphone boom arm. Nylon and  
stainless steel unbreakability. Tropicalised. New design cable  
minimises crosstalk. Get details in full, today, from

**AMPLIVOX**  
LIMITED

AMPLIVOX LIMITED INDUSTRIAL DIVISION,  
Beresford Avenue, Wembley, Middlesex Tel 01-902 8991, Grams & Cables: Amplivox, Wembley.

HIGH FIDELITY MOVING COIL STEREO HEADPHONES (TYPE L.S.43) Now available from Davstrom Ltd. Gloucester.  
WW-008 FOR FURTHER DETAILS

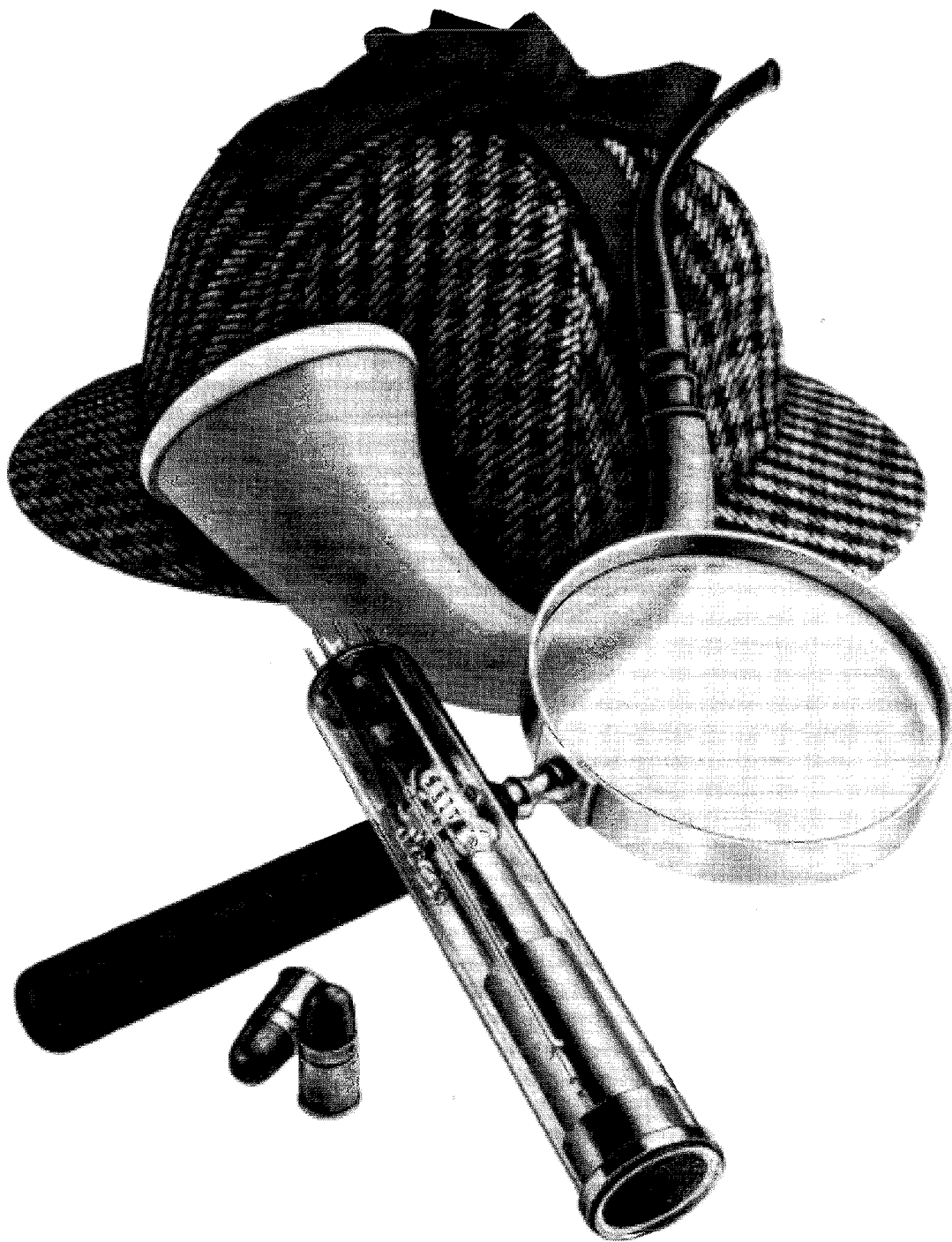

## To catch a thief...

Closed circuit television is proving very sleuthful in keeping an eye on things. But when it comes to watching Rembrandts and Goyas it has to be reliable. This is where EEV high sensitivity vidicons should be used. These tubes can give up to 8000 hours viewing without dropping off in performance. They also provide unusually high resolution, high sensitivity and short lag. EEV vidicons are available with two different values of heater current, 6.3V/600mA and 6.3V/95mA, and with either separate mesh or integral mesh construction. For further information and the name and address of your nearest stockist write to:

**ENGLISH ELECTRIC VALVE COMPANY LIMITED**

WW—009 FOR FURTHER DETAILS

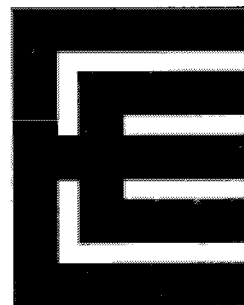
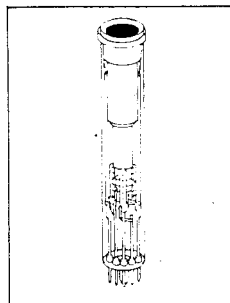

CHELMSFORD, ESSEX. TELEPHONE: 61777

AP295

# Specifying electronic components made in the U.S.A. is your business.

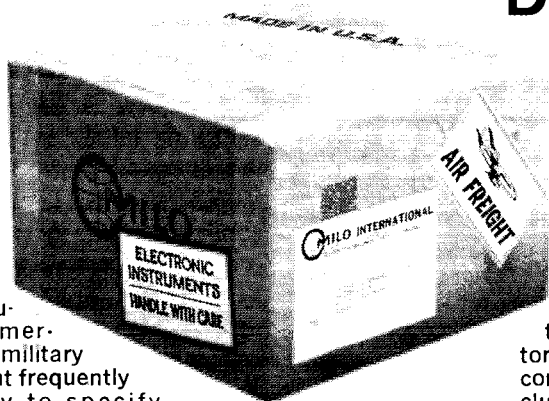

All over the world, designers and manufacturers of commercial, industrial and military electronic equipment frequently find it necessary to specify American-made components. Too often, however, the technical details and complex paperwork of international commerce have been thought of as costly, time-consuming obstacles in getting the components delivered promptly and accurately.

To help overcome those obstacles, Milo International offers its specialized facilities and years of experience as a leading world-wide supplier of electronic components. Whether you need only a few pieces of one component, or large quantities of many items, your order will receive our complete all-inclusive service—from immediate price and delivery quotations to processing of all certificates, licenses and declarations to special export packaging and delivery expediting.

## Delivering them to you is ours.

The next time your business needs electronic components from the U.S.A., let us show you how our business can get them delivered to you—quickly and efficiently, at direct factory prices, from our huge in-stock inventory of thousands of components made by the leading American manufacturers including this partial listing:

Amperex	Eimac	R.C.A.
Amphenol	Electrons, Inc.	Raytheon
Arrow-Hart & Hegeman	Erie	Simpson
Bourns	General Electric	Sola
Burgess	Hardwick Hindle	Solitron
Cannon	Hickok	Sprague
Centralab	I.T.T.	Stancor
Cinch-Jones	J.F.D.	Superior
Clarostat	Kings	Sylvania
Cornell-Dubilier	Littelfuse	Texas Instruments
Corning	Mallory	Transitron
Dale Electronics	Oak	United Transformer
Delco Radio	Ohmite-Allen Bradley	Vector
	Potter & Brumfield	Xcelite

For immediate price and delivery quotations, contact Milo by mail, phone, cable or International Telex.

 **MILO International**  
World-Wide Electronic Component Suppliers

530 Canal Street, New York, N.Y. 10013 / Tel 212-233-2980 / Cable MILOELECTRO, N.Y. / Int'l. Telex 62528

WW—010 FOR FURTHER DETAILS



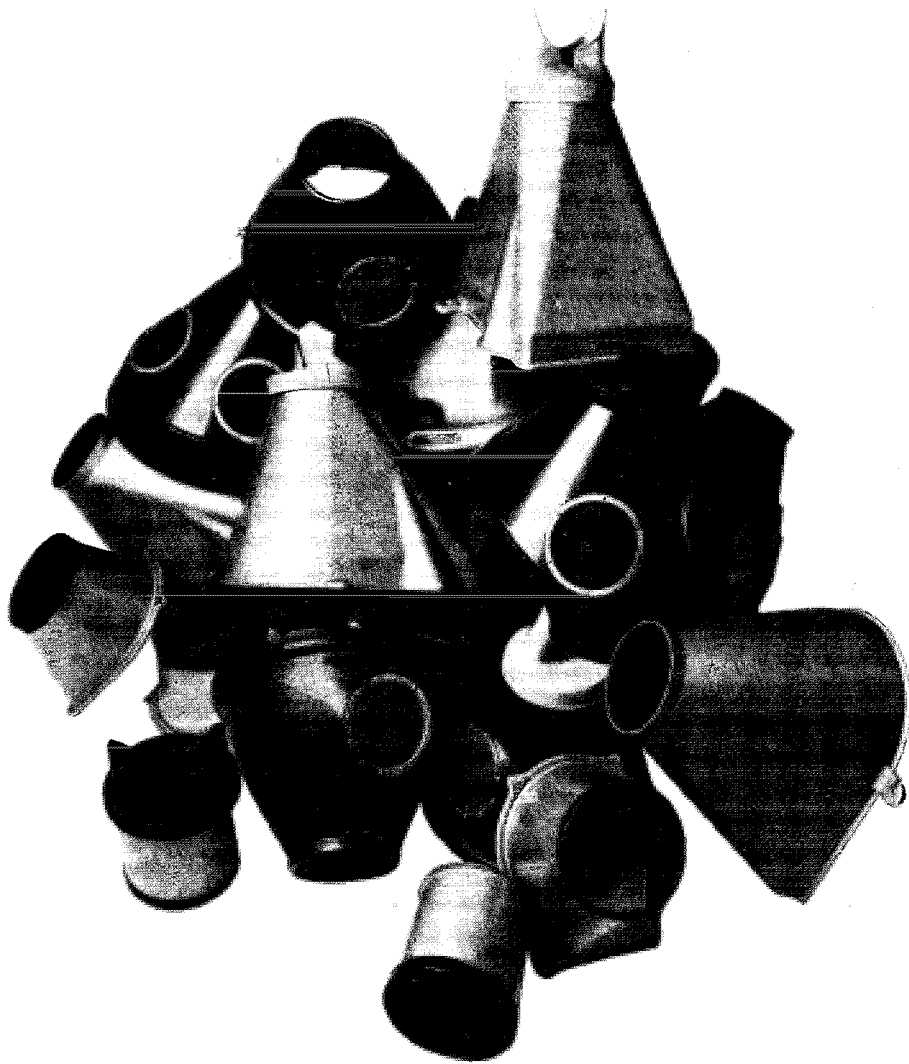

## Throw those hoods away

No viewing hood is necessary with the EEV high brightness storage tubes. They give a brightness 50 to 100 times greater than normal long persistence cathode ray tubes. Used for air traffic control and other radar applications, they permit observation of a large area display in broad daylight; even direct sunlight on the face-plate calls for only a simple filter. The high brightness display, unrestricted by a viewing hood, increases operator efficiency and minimises fatigue. Full information on high brightness storage tubes, and on conventional CRTs, will be sent on request.

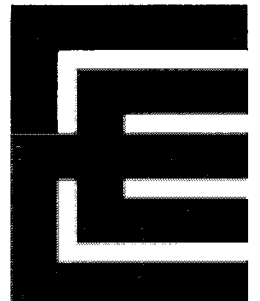
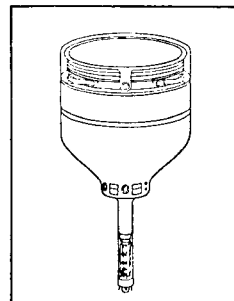

**ENGLISH ELECTRIC VALVE COMPANY LIMITED**  
WW-011 FOR FURTHER DETAILS

CHELMSFORD, ESSEX. TELEPHONE: 61777

AP301

# Custom built amplifier installations from standard modules



Philips introduce versatile audio system.

Philips make it very easy for you to realise your own ideas for an audio system, by introducing an exclusive new formula based on two principles: modular construction and stacking ability.

Our modules are designed with common dimensions, styling and controls and are easily stacked.

The resulting high quality system can be extended when the need arises by stacking additional items.

Philips modules enable you to meet your plans exactly, without compromise — efficiently and economically.

Use them individually or stacked; free standing or wall mounted and where required, in 19 inch racks.

Cases are finished in dark grey which, combined with the lighter grey of the panels, achieve a pleasant two-tone effect.

The modular range includes: 25 W, 50 W and 100 W power amplifiers (stackable to provide higher outputs if required); preset, mixing, and push button pre-amplifiers (with remote control facilities) which fit into each of the power amplifiers; an AM/FM radio tuner; a record player and an automatic tape recorder. The range is completed by a series of complementary accessory units, including 19 inch rackmounting panels.

Intermatching and other problems common to conventional equipment are completely eliminated. Choose your input, control and output requirements, then make the combination.

Installations are ready for immediate use, suitable for continuous operation, reliable.

Use the Philips stacking system and obtain the exact audio system required for any indoor or outdoor application.

## Equipment survey of the Philips stackable audio module system

The basic components of the system are housed in attractively styled standardised modular cabinets, finished in dark grey with light grey fronts. Cabinet width is 400 mm, depth 350 mm. The high quality equipment is suitable for all audio applications and for continuous operation. Reliable solid state circuitry throughout. Complete coverage of the audible spectrum at extremely low distortion.

### Power amplifiers

Fully transistorised high quality power

amplifiers for use in all audio installations. Mains powered. Easy selection of output voltage by means of movable sockets at the rear of the cabinet. Built-in limiter with push-button control on front panel. Input from various interchangeable pre-amplifiers which fit into the housing. Up to five power amplifiers may be fed from one pre-amplifier.

Mains voltages: 110, 127, 220, 245 V.

Distortion: 1.5% at nominal output.

Output voltage: loudspeaker output 100, 70, 50, 35, 25, 10 V; line output 4 V.

Sensitivity: 100 mV adjustable.

DC supply: a DC voltage is supplied by the power amplifier to feed the pre-amplifier.

Height: 115 mm, stacked 105 mm.

*25 W power amplifier LBB 1001*

output power: 25 W.

power consumption: no load 16 W,

full load 75 W.

*25 W mixing amplifier LBB 1021*

as LBB 1001 with mixing pre-amplifier LBB 1020.

*50 W power amplifier LBB 1002*

output power: 50 W.

power consumption: no load 41 W,

full load 153 W.

*50 W mixing amplifier LBB 1022*

as LBB 1002 with mixing pre-amplifier LBB 1020.

*100 W power amplifier LBB 1003*

output power: 100 W.

power consumption: no load 33 W,

full load 283 W.

*100 W mixing amplifier LBB 1023*

as LBB 1003 with mixing pre-amplifier LBB 1020.

### Pre-amplifiers

Pre-amplifiers are special units which fit into each of the basic power amplifiers. Controls are grouped on a panel, which replaces a blind section of the power amplifiers front. Supply voltages are obtained from the power amplifier. Distortion: 0.5% (40 . . . 20 000 Hz).

*preset pre-amplifier LBB 1010*

Inputs: 4 microphone channels, sensitivity 0.3 mV.

1 channel, sensitivity 100 mV for use with a crystal pick-up, radiotuner or tape recorder.

Presettings: separate gain adjustments per input channel.

Front control: common gain control — fader type — for the overall programme level.

*LBB 1020 mixing pre-amplifier*

Inputs: 2 microphone channels, 2 channels adaptable as microphone channels or as input channels for crystal or dynamic pick up, by using microphone insert LBB 1025 or gramophone insert LBB 1026.

Presettings: separate gain control per microphone input channel.

Front controls: 4 separate gain controls — fader type — for each of the input channels,

1 common bass control — fader type  
1 common treble control — fader type  
2 separate bass cut switches for each of the microphone channels.

*Screw-in microphone insert LBB 1025* to extend the input possibilities of mixing pre-amplifier LBB 1020.

*Screw-in gramophone insert LBB 1026* to extend the input possibilities of mixing pre-amplifier LBB 1020.

*Push-button pre-amplifier LBB 1030*

Inputs: 4 universal channels, one of which has priority function, max. sensitivity 0.3 mV.

Presettings: sensitivity per channel, bass cut per channel, gain per channel,

common bass and treble adjustments.

Front controls: 4 independent push-buttons for channel selection and 1 common cancellation push-button; selection buttons are illuminated when operated; channel 1 has priority e.g. for emergency; 1 common gain control — fader type — for channels 2, 3 and 4.

Remote control: The pre-amplifier has connections for remote control and signalling on all channels.

Power amplifier

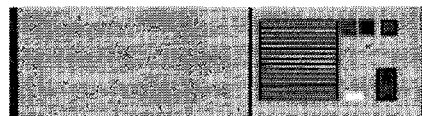

... with mixing pre-amplifier

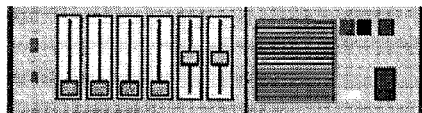

... with push-button pre-amplifier

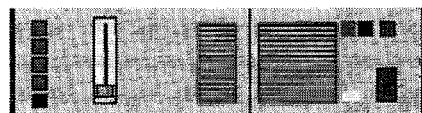



Tuner

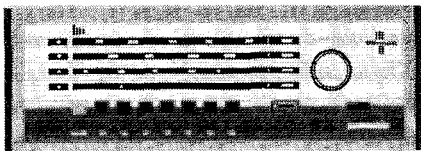

Record player

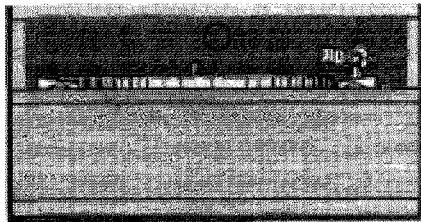

Recorder

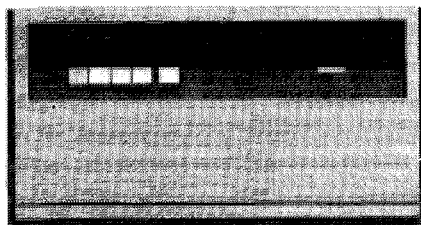

**Tuner, record player and recorder equipment**

*radio tuner LBB 1037*

Consisting of the high quality radio tuning unit GH 924, built into a standard stackable cabinet.

Frequency bands: 150 . . . 400 KHz (long wave)

517 . . . 1622 KHz (medium wave)

5.9 . . . 18.2 MHz (short wave)

87.5 . . . 108 MHz (FM band) (the FM section is equipped with stereo facilities)

Height: 150 mm, stacked 140 mm.

*record player LBB 1038*

Consisting of the high quality record player GC 030 built into a stackable cabinet. Drawer type chassis and tinted methacrylate front. The module cabinet is also available separately with a blank chassis, suitable for mounting any other record player.

Chassis is self-locking when pushed into the cabinet.

Height: 220 mm, stacked 210 mm.

*tape recorder LBB 1039*

Consisting of the high quality tape recorder EL 3572, built into a stackable cabinet. The recorder is

mounted on a drawer type chassis which is self locking when pushed into the cabinet.

Height: 220 mm, stacked 210 mm.

**Accessories**

*cable transformers LBC 1100*

Completely mu-metal screened 500  $\Omega$  / 500  $\Omega$  high quality microphone transformers for isolating or balancing purposes.

*Mounting sets LBB 1045*

Two threaded rods of 140 cm length, two strips, four nuts and four washers. Rods can be cut to length after mounting.

*19 inch rack mounting panels LBB 1035 and LBB 1036*

For mounting stackable modules in existing 19 inch systems.

*Mounting hinges LBB 1046*

For mounting a complete stack to a wall.

*Electro-acoustics Division  
of Philips Industries,  
N.V. Philips' Gloeilampenfabrieken,  
Eindhoven, The Netherlands.*

**PHILIPS**

WW—013 FOR FURTHER DETAILS

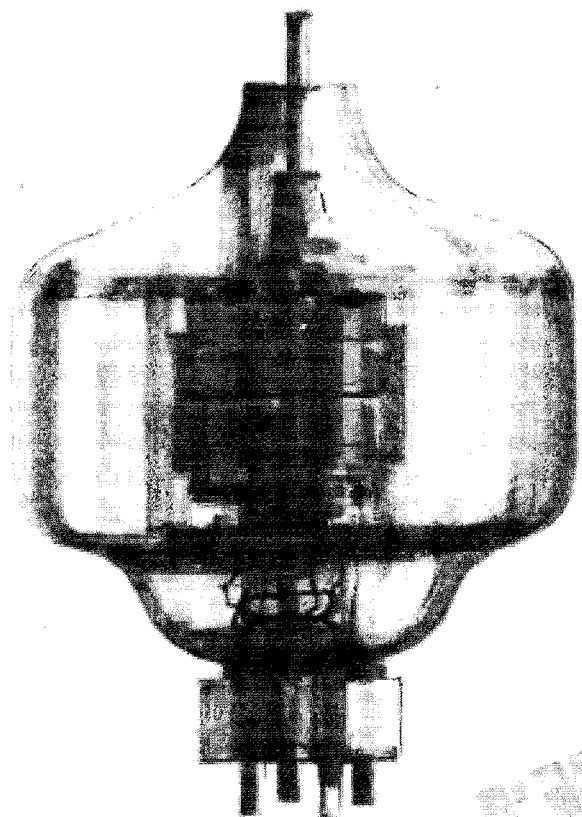

FOR SUPERB QUALITY AND WORLD WIDE DISTRIBUTION **HALTRON** OFFER A VAST SELECTION OF VALVES FOR ALL AREAS OF RESEARCH AND INDUSTRY

**HALTRON**

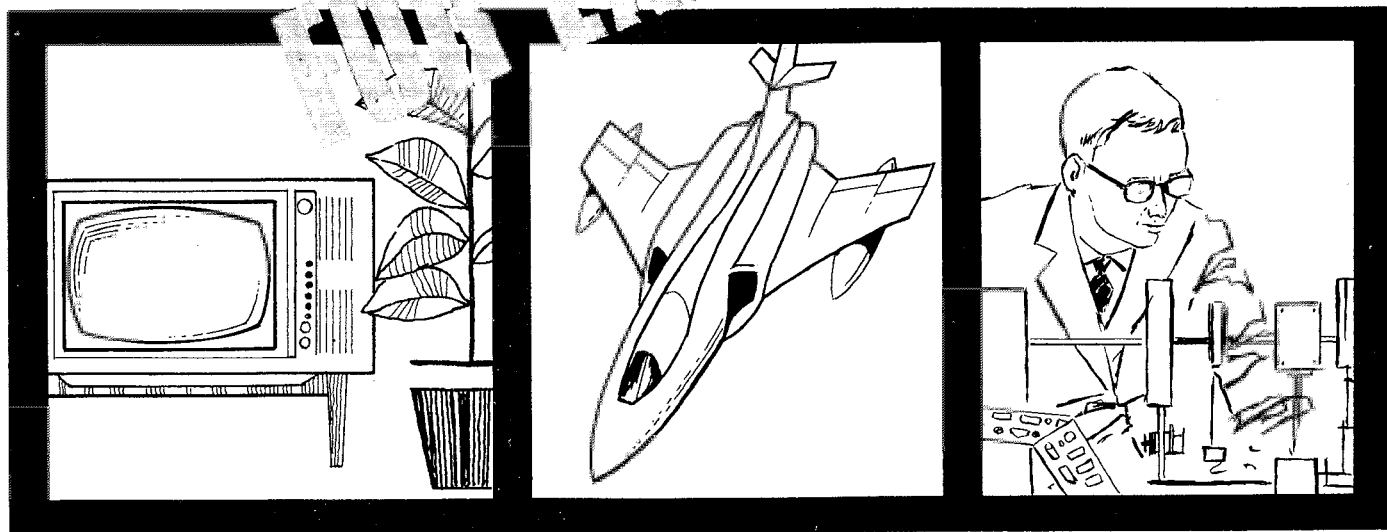

FOR QUALITY, RELIABILITY AND WORLD-WIDE AVAILABILITY, RELY ON HALL ELECTRIC'S SPEED, INTELLIGENCE AND REPUTATION

VALVES FOR:  
Radio and Television Manufacturers.  
Radio and Television Service Departments.  
Radio Relay Companies.  
Audio Equipment.  
Electronic Equipment.  
Instrumentation.  
Computers.  
Marine Radar.  
Communication Equipment.  
Research and Development.  
Government Departments.  
Aircraft Military and Civil.  
Ministry of Aviation Approved Inspection.  
Air Registration Board Approved Inspection.

# **HALTRON**

## **RADIO VALVES & TUBES**

All enquiries to:  
Hall Electric Ltd., Haltron House, Anglers Lane, London, N.W.5.  
Telephone: 01-485 8531 (10 lines). Telex: 2-2573. Cables: Hallelectric, London, N.W.5.

**WW-014 FOR FURTHER DETAILS**

# If you solder, then send for this...

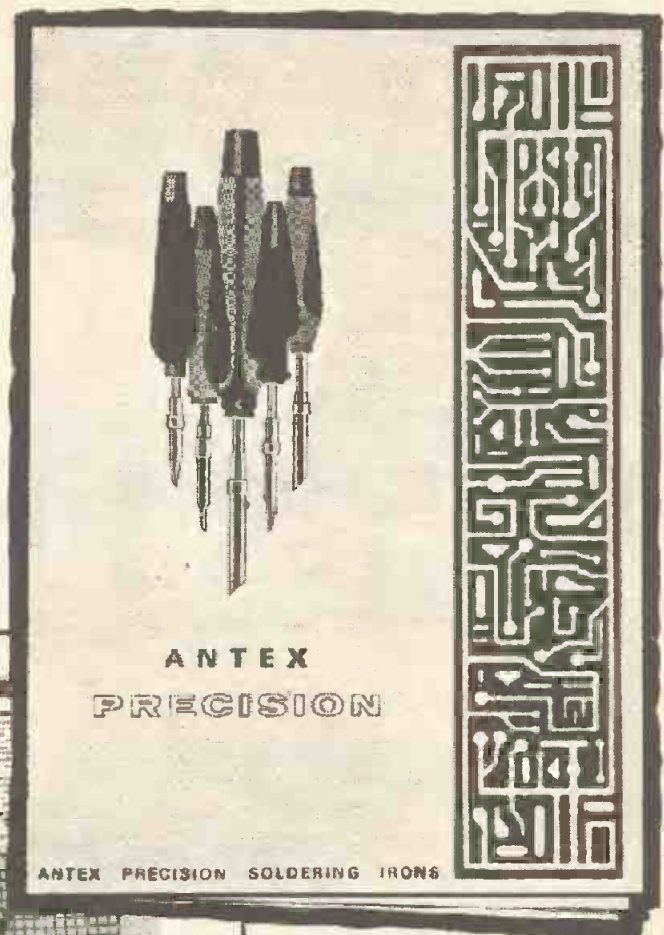
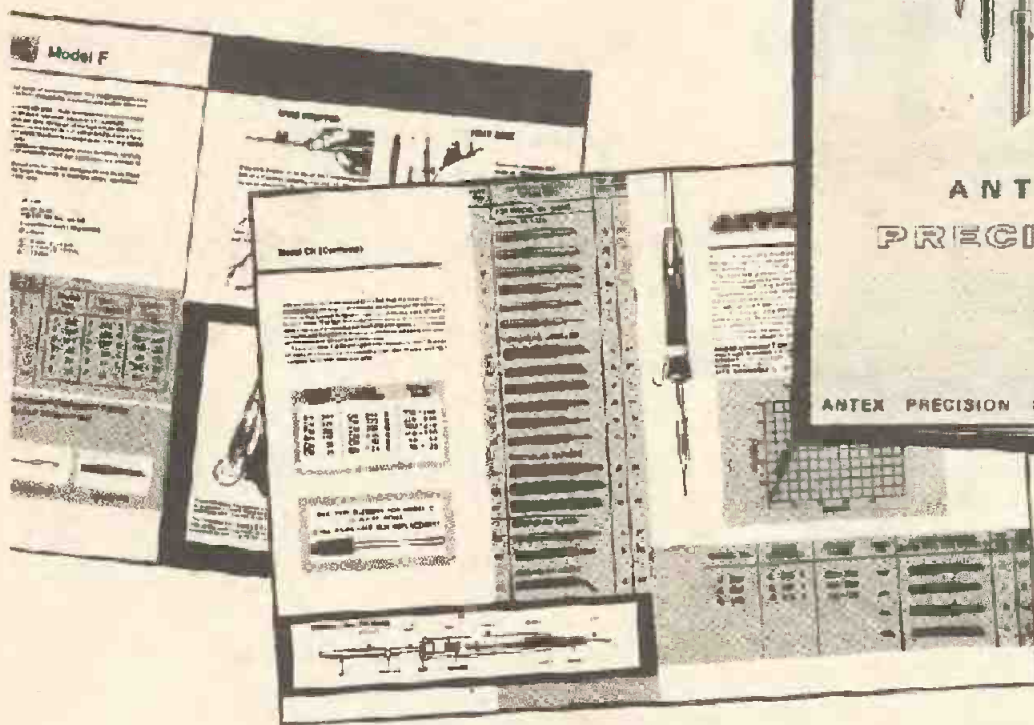

If your production processes call for fine precision soldering, then you must have the new Antex Precision Soldering Equipment Catalogue. This details the range of Antex irons, with complete performance specifications, full details of spare bits etc., as well as information on de-soldering tools, iron stands etc. In fact its 16 pages (in colour!) deal with every aspect of Precision Soldering. And it's free—just send off the coupon.

**TO: ANTEX LIMITED  
GROSVENOR HOUSE, CROYDON, CR9 1QE**

*Please send me \_\_\_ copies of the Antex  
Precision Soldering Catalogue*

NAME \_\_\_\_\_

POSITION \_\_\_\_\_

COMPANY \_\_\_\_\_

ADDRESS \_\_\_\_\_

\_\_\_\_\_

\_\_\_\_\_

W6

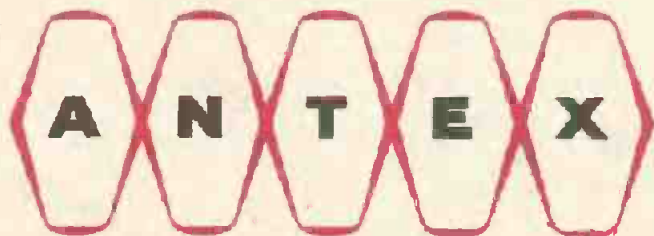

ANTEX LIMITED · GROSVENOR HOUSE · CROYDON CR9 1QE · Telephone: 01-686 2774

WW—015 FOR FURTHER DETAILS

# The "New Look" In Instrumentation is From Heathkit



**KIT IM-25**  
**£48.10.0** P.P. 7/6

Ready to use prices on request of all models.

The newest and most practical innovation in electronic instrumentation is the exciting new ultra-functional styling format from Heath. New instruments feature a unique cabinet styling frame consisting of the front and rear panels and side rails which completely supports the component chassis independently from the top and bottom cabinet shells. This allows complete freedom from assembly, check-out, and calibration. The sturdy side rails conceal retractable carrying handles. The die-cast front panel bezel styled in chrome and black, the black side rails, and the beige front panels and cabinet shells give the new instruments an appearance as up-to-date as their functional performance.

## New Solid-State High-Impedance Volt-Ohm Milliammeter . . . IM-25

- 9 A.C. and 9 D.C. voltage ranges from 150 millivolts to 1500 volts full scale
- 7 resistance ranges, 10 ohms centre scale with multipliers  $\times 1$ ,  $\times 10$ ,  $\times 100$ ,  $\times 1k$ ,  $\times 10k$ ,  $\times 100k$ , and  $\times 1$  meg . . . measures from one ohm to 1000 megohms
- 11 current ranges from 15 $\mu$ A full scale to 1.5A full scale
- 11 megohm input impedance on D.C.
- 10 megohm input impedance on A.C.
- A.C. response to 100 kHz
- 6in. 200 $\mu$ A meter with zero-centre scales for positive and negative voltage measurements without switching
- Internal battery power or 120/240 volt A.C., 50-60 Hz
- Circuit board construction for extra-rugged durability.

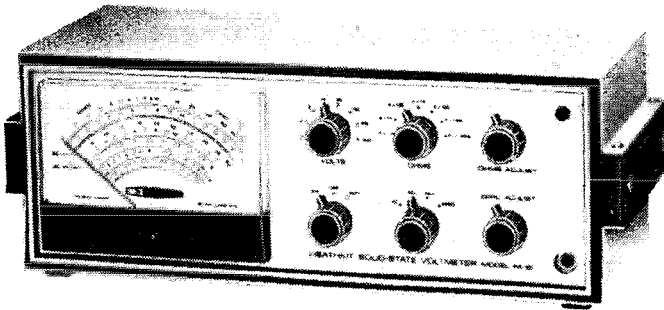

**KIT IM-16**  
**£28.8.0** P.P. 6/-

## New Solid-State Volt-Ohm Meter, IM-16

- 8 A.C. and 8 D.C. ranges from 0.5 volts to 1500 volts full scale
- 7 ohm-meter ranges with 10 ohms at centre scale and multipliers of  $\times 1$ ,  $\times 10$ ,  $\times 100$ ,  $\times 1k$ ,  $\times 10k$ ,  $\times 100k$ , and  $\times 1$  megohm
- 11 megohm input on D.C. ranges, 1 megohm on A.C. ranges
- Operates on either built-in battery power or 120/240 volt A.C., 50-60 Hz
- Circuit-board construction.

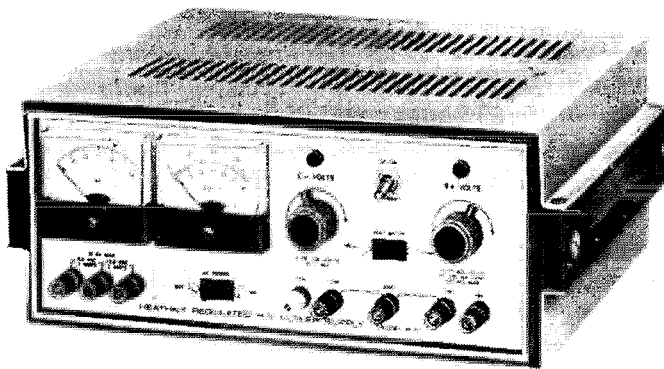

**KIT IP-17**  
**£37.4.0** P.P. 10/6

## New Variable Control Regulated High Voltage Power Supply . . . IP-17

- Furnishes 0 to 400 volts D.C. @ 100 mA maximum with better than 1% regulation for 0 to full load and  $\pm 10$  volt line variation
- Furnishes 6 volt A.C. @ 4 amperes and 12 volt A.C. @ 2 amperes for tube filaments
- Provides 0 to -100 volts D.C. bias @ 1 milli-ampere maximum
- Features separate panel meters for continuous monitor for output current and voltage
- Terminals are isolated from chassis for safety
- High voltage and bias may be switched "off" while filament voltage is "on"
- Modern circuit board and wiring harness construction
- 120/240 volt A.C., 50-60 Hz operation.

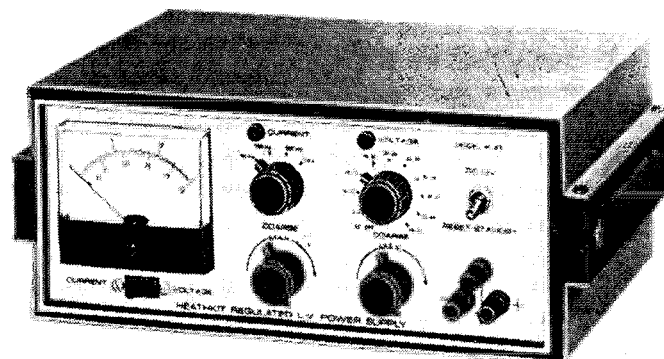

**KIT IP-27**  
**£46.12.0** P.P. 9/-

## New Improved Version of the famous Heathkit Solid-State, Voltage-Regulated, Current-Limited Power Supply . . . IP-27

- New zener reference
- New improved circuitry is virtually immune to overload due to exotic transients
- 0.5 to 50 volts D.C. with better than  $\pm 15$  millivolts regulation
- Four current ranges 50 mA, 150 mA, 500 mA and 1.5 amperes
- Adjustable current limiter: 30 to 100% on all ranges
- Panel meter shows output voltage or current
- "Pin-ball" lights, indicate "voltage" or "current" meter reading
- Up-to-date construction
- Unequaled performance in a laboratory power supply.

Many other instruments in range why not send for the **FREE CATALOGUE and INSTRUMENT BROCHURE**

Full specification sheet available on any **HEATHKIT** model from

**DAYSTROM LTD.**

DEPT. WW-5, GLOUCESTER, ENGLAND

Member of the Schlumberger Group including the Heath Company

MANUFACTURERS OF THE WORLD'S LARGEST SELLING ELECTRONIC KITS

Please use coupon on right. 

# The 'World's Best Buys' in Electronics come from **Heathkit**

All models are available in ready-to-use or kit form.

## Latest Portable Stereo Record Player SRP-1

This stereo, fully transistorised, mains operated player offers new standards of reproduction. Automatic playing of 16, 33, 45 and 78 r.p.m. records. All transistor—cool instant operation. Dual LP/78 stylus. Plays mono or stereo records. Suitcase portability. Detachable speaker enclosure for best stereo effect. Two 8in. X 5in. special loudspeakers. For 220-250V, a.c. mains operation. Overall cabinet size 15 $\frac{1}{2}$  X 3 $\frac{3}{8}$  X 10 $\frac{1}{2}$ in. Choice of handsome two-tone blue and grey or red and grey fabric coverings. Compact, economical stereo and mono record playing for the whole family—plays anything from the Beatles to Bartok. All solid-state circuitry gives room-filling volume.

Kit £28.6.0 incl. P.T. p.p. 10/6 Ready-to-use £35.4.0 p.p. 10/6

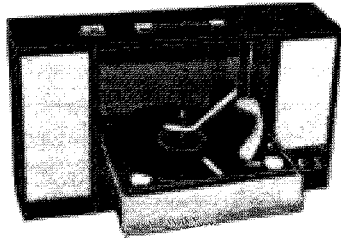

## Latest Portable Stereo Tape Recorder STR.1

No other British model offers this specification for this price. Not only a tape recorder but a complete stereo sound system in one compact unit  $\frac{1}{2}$ -track stereo or mono record and playback at 7 $\frac{1}{2}$ , 3 $\frac{3}{4}$  and 1 $\frac{1}{2}$  i.p.s. Latest 18 transistor circuit. Recording level indicator. Well known British deck with digital counter. Stereophonic mic. and aux. inputs. Speaker/headphone outputs. Built-in audio amplifiers give 4 watts output (rms) per channel. Two high efficiency 8in. X 5in. loudspeakers. Versatile recording facilities. So easy to build. Attractive black Rexine cabinet with pastel grey matching panels.

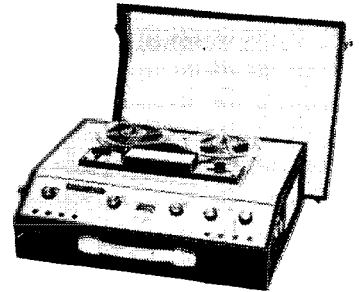

Kit £58.0.0 incl. P.T. p.p. 10/6. Ready-to-use £70.6.0 p.p. 10/6

## UXR-1—Portable Radio

Strong, robust construction with reliable performance. 6 transistor, 1 diode circuit provides the power and range you can't get from miniatures. Covers long and medium wavebands. Cabinet finished in beautiful real leather or in the attractive colours Navy Blue, Coral Pink, Lime Green (please state second choice).

Kit £12.8.0 colour case p.p. 4/6  
Ready-to-use £14.8.0 ,, p.p. 4/6  
Kit £13.8.0 leather p.p. 4/6  
Ready-to-use £15.10.0 ,, p.p. 4/6

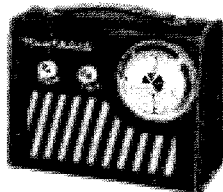

## UXR-2—Portable Radio

A De-luxe 7 transistor, 3 diode circuit offers big-set sound. Battery saving circuitry—batteries last for months. Push buttons for Long and Medium wave coverage and tone control. Easy-tune slide-rule dial. Double tuned I.F. stage. Output for phone or tape recorder. Choice of real brown or black leather case and handle.

Kit £15.0.0 p.p. 6/-  
Ready-to-use £17.10.0 p.p. 6/-

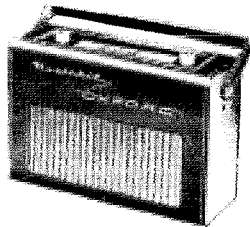

## LUXURY Class Car Radio, CR-1

A small, compact, high output unit. Superb long and medium wave entertainment whenever you drive. For 12v. positive or 12v. negative car earth system. 8 latest semi-conductors (6 transistors, 2 diode circuit). Powerful output (4 watts) will drive two speakers. Styled to harmonise with most car colour schemes. Supplied in two units, pre-assembled and aligned RF unit kit. £1/13/6 incl. P.T. IF/AF amplifier kit £11/3/6, both models required.

Kit £12.18.6 incl. P.T. p.p. 4/6  
Loudspeaker £1.2.3 extra.  
Ready-to-use £19.12.6 p.p. 4/6

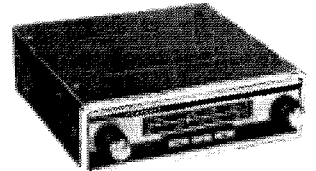

## AVON Mini SPEAKER

Excellent performance from small size 6 $\frac{1}{2}$ in. Bass, 3 $\frac{3}{8}$  mid/high frequency unit. Inductor/capacitor cross over network. Supplied in two units, both required.

Total Kit £14.0.0 incl. P.T. p.p. 10/6  
Ready-to-use £18.18.0 p.p. 10/6

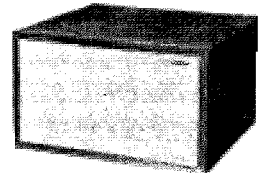

Many other models, SEND FOR THE FREE CATALOGUE

IM-17



## NEW Portable Solid-State Volt Ohm Meter

Just right for the home owner, boater, model builder, hams... sophisticated enough for even radio and T.V. servicing. Solid-state circuit. FET input, 4 silicon transistor, 1 diode, 4 A.C. voltage ranges, 4 D.C. voltage ranges, 4 ohm ranges, 11 megohm input on D.C. 1 Megohm input on A.C., 4 $\frac{1}{2}$ in. 200 $\mu$ A meter. Battery powered. Rugged polypropylene case with self cover and handle. Storage space for test leads. PCB construction.

Kit £12.12.0 p.p. 4/6  
Ready to use, price on request.

## Transistorised 12 + 12 w. Stereo Amplifier, TSA-12

This luxury-quality amplifier utilises transformerless output circuitry giving superior performance, lower phase shift, wider response and lower distortion. It delivers 12 watts R.M.S. per channel into 8 ohms over an extremely wide frequency range of 16 to 50,000 c/s. A six-position source switch easily handles your records, radio or auxiliary inputs—stereo or mono. Baxendall type tone controls for Bass and Treble boost and cut. Its high class performance is matched only by its sleek and attractive low silhouette styling.



Kit £30.10.0 Ready-to-use £38.0.0 p.p. 10/6  
(cabinet £25.0 extra.)

Visit the HEATHKIT CENTRES

GLOUCESTER:  
Bristol Road. Tel: 29451

LONDON:  
233 Tottenham Court Road. Tel: 01-636 7349

BIRMINGHAM:  
17-18 St. Martin House, Bull Ring.  
Tel: 021-643 4386

Demonstrations by arrangement.

SEND FOR FREE CATALOGUE

DAYSTROM LTD., Dept. WW6  
Gloucester, England. Tel.: 29451

Please send further details of model(s)

Please send FREE British Heathkit Catalogue.

NAME

ADDRESS

HEATHKIT by DAYSTROM

Prices and specifications subject to changes without notices

WW-017 FOR FURTHER DETAILS

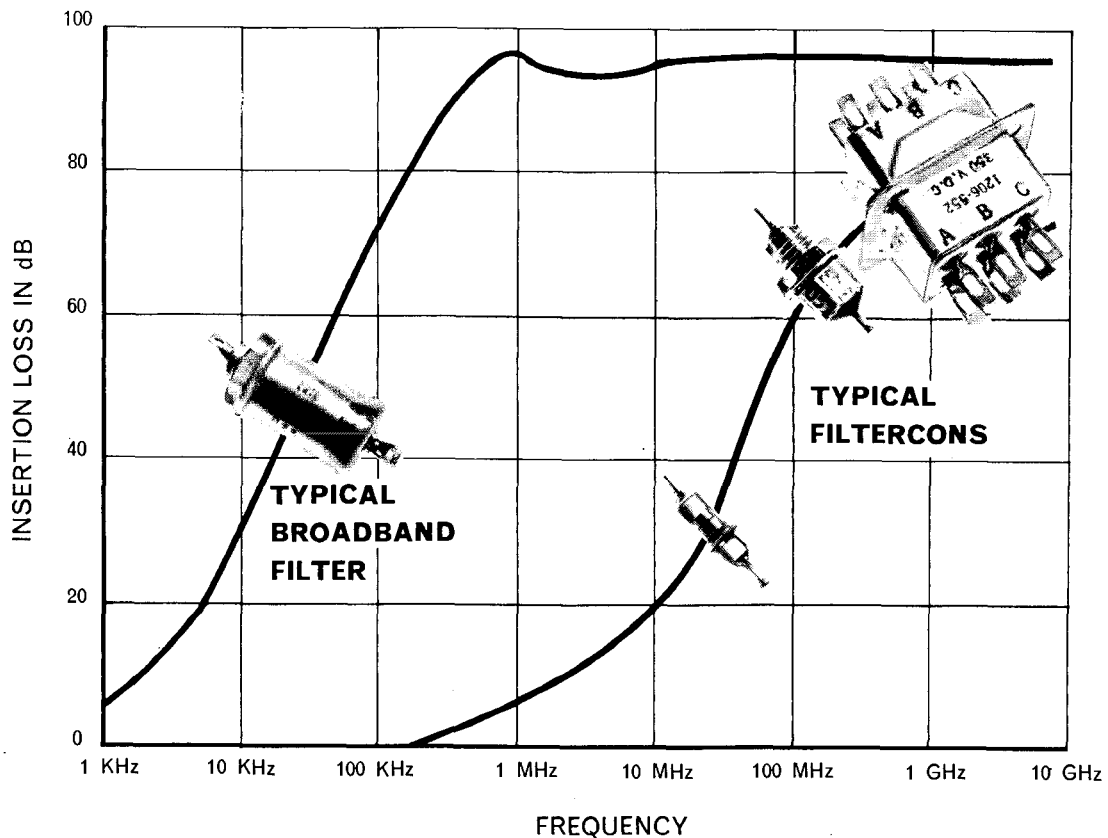

# Our filters give higher attenuation in a fraction of the space

## Broadband Filters offer:

1. Highest attenuation at the lowest frequencies in the smallest package.
2. Typical cut-off frequency of 2 kHz in less than  $\frac{1}{4}$  size of a conventional filter.
3. Excellent performance to beyond 10 GHz.
4. Hermetically-sealed, robust metal housing providing protection against the most stringent environments over the temperature range  $-55^{\circ}\text{C}$  to  $+125^{\circ}\text{C}$ .
5. Internal construction incorporating unique Erie rolled ceramic capacitor elements in an L network with ferrite or monolithic elements in a Pi or T network with toroids.
6. Selected styles approved for military and aerospace applications.

## Filtercons offer:

1. Highest attenuation in smallest size at lowest cost.
2. Typical cut-off frequency of 2 MHz in a wide range of styles.
3. Excellent performance to beyond 10 GHz.
4. Wide range of robust configurations for solder-mounting, bush-mounting and multi-assemblies, for reliable operation over the temperature range  $-55^{\circ}\text{C}$  to  $+125^{\circ}\text{C}$ .
5. Internal construction incorporating ceramic capacitor elements and ferrites in a Pi network.
6. Selected for major military and aerospace applications.

Erie Broadband Filters and Filtercons eliminate interference caused by switches, relays, motor commutators, SCR's and transistor switching. These filter devices are exceptional in that in a volume less than 1 cubic centimetre they offer typically an insertion loss of 80 dB minimum in the range 150 kHz to over 10 GHz.

The components on the graph are illustrated life size.

Contact us for fuller details. Technical Sales,  
**Erie Electronics Limited,\***  
 South Denes,  
 Great Yarmouth, Norfolk.  
 Phone: 0493 4911.  
 Telex: 97421.

Filtercon is a registered trade mark



\* Formerly Erie Resistor Limited

WW-018 FOR FURTHER DETAILS



# prepare now for tomorrow's world

Today there is a huge demand for technologists such as electronics, nuclear and computer systems engineers, radio and television engineers, etc. In the future, there will be even more such important positions requiring just the up-to-date, advanced technical education which C.R.E.I., the Home Study Division of McGraw-Hill Book Co., can provide.

C.R.E.I., Study Programmes are directly related to the problems of industry including the latest technological developments and advanced ideas. Students claim that the individual tuition given by the C.R.E.I. panel of experts in each specialised field is comparable in technological content with that of technical colleges.

## Why C.R.E.I. Courses are best

No standard text books are used — these are often considerably out-of-date when printed. C.R.E.I. Lesson Material contains information not published elsewhere and is kept up-to-date continuously. (Over £50,000 is spent annually in revising text material.)

Step-by-step progress is assured by the concise, simply written and easily understood lessons. Each programme of study is based on the practical applications to, and specific needs of, Industry.

Take the first step to a better job now—enrol with C.R.E.I., the specialists in Technical Home Study Courses.

## C.R.E.I. PROGRAMMES ARE AVAILABLE IN:

**Electronic Engineering Technology \* Industrial Electronics for Automation \* Computer Systems Technology \* Nuclear Engineering \* Mathematics for Electronics Engineers \* Television Engineering \* Radar and Servo Engineering**

**City and Guilds of London Institute: Subject No. 49 and Advanced Studies No. 300.**



The highest level of  
Technical Home Study.

C.R.E.I. (London), Walpole House,  
173-176 Sloane Street, London S.W.1.  
A subsidiary of McGraw-Hill Inc.

## POST THIS COUPON TODAY FOR A BETTER FUTURE

To C.R.E.I. (London), Walpole House, 173-176 Sloane Street, London, S.W.1.  
Please send me (for my information and entirely without obligation) full details of the Educational Programmes offered by your Institute.

My interest is City and Guilds  please tick General

NAME \_\_\_\_\_

ADDRESS \_\_\_\_\_  
\_\_\_\_\_

EDUCATIONAL BACKGROUND \_\_\_\_\_

ELECTRONICS EXPERIENCE \_\_\_\_\_

WW 107

WW—019 FOR FURTHER DETAILS

# BREAK THE SOUND BARRIER



MODEL 488 SONO-BAR



MODEL 419 RANGER II

SHURE MICROPHONES—  
WORLD STANDARD WHEREVER  
RELIABILITY AND  
SOUND QUALITY ARE PARAMOUNT

WITH PROVED **SHURE** SETTING THE WORLD'S STANDARD IN SOUND

## NOISE CANCELLING MICROPHONES

When the chips are down, and noise levels are high, Shure Noise Cancelling microphones with their exclusive Controlled Magnetic cartridges, distance-discrimination design, and specially tailored response get the message through . . . *even when noise level is so high the operator cannot hear himself!* They have been field-tested and proved in such ear-shattering environments as: drop forges, helicopters, police power boats, "hard surface" gyms among cheering crowds, motorcycles, jets revving up, fire engines, etc.

### SHURE MODEL 488 SONO-BAR

Rugged, impact resistant "Armo-Dur" case. Four types: High or low impedance; transistorized for direct replacement of carbon microphone; and FAA Certified Transistorized Aircraft version.

### SHURE MODEL 419 RANGER II

New small size. Only about half the size and weight of conventional mobile communications microphones. Unsurpassed for use with portable or miniaturized equipment.

Please send me details of Shure microphones. Please recommend the best model for use with my equipment.....

NAME.....

ADDRESS.....

TO SHURE ELECTRONICS LTD • 84 BLACKFRIARS ROAD • LONDON • SE1 Tel: 01-928 6361

WW-020 FOR FURTHER DETAILS

# The new 'WESTMINSTER' solid-state radiotelephone ...from PYE designed for world markets

The new range of 'Westminster' solid-state radiotelephones is ready for operation anywhere in the world. Pre-production models successfully endured every possible combination of adverse climatic, regional, shock and vibration extremes for over a year. This exacting field-test programme has proved the 'Westminster' range of radiotelephones suitable for global operation. The 'Westminster' range is type-approved in many countries; dash, universal or motorcycle versions are available.

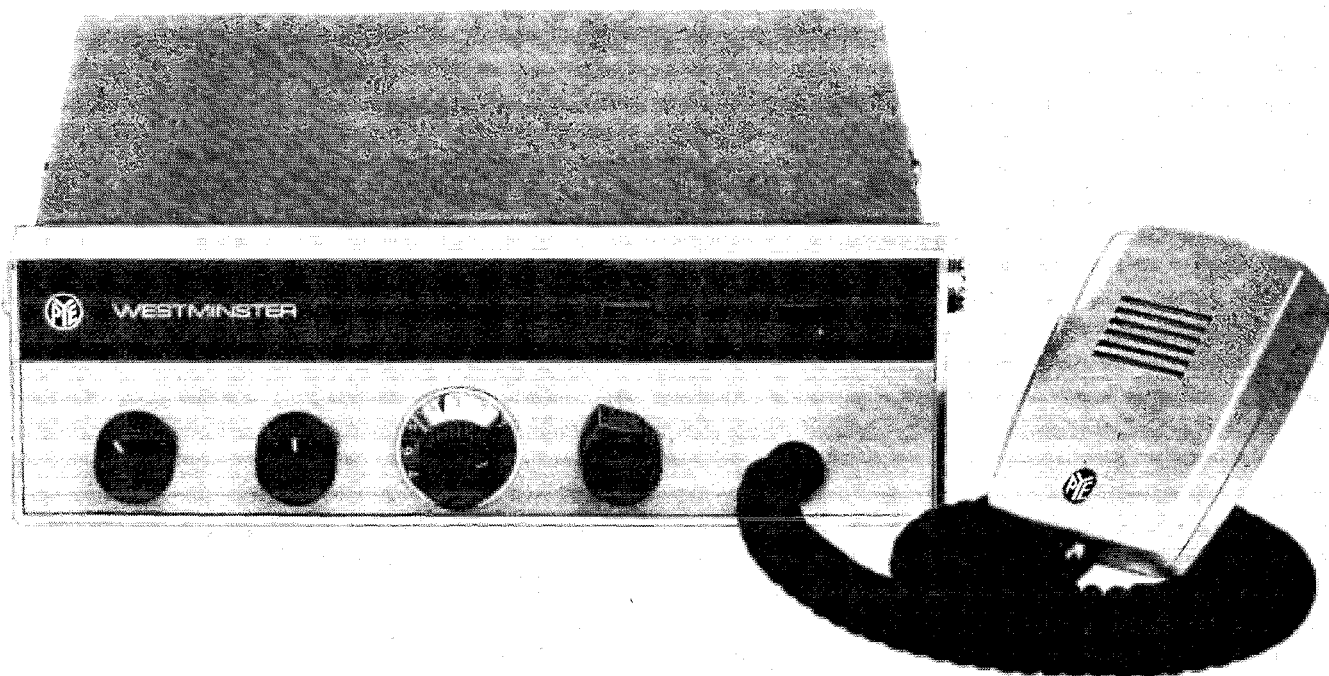
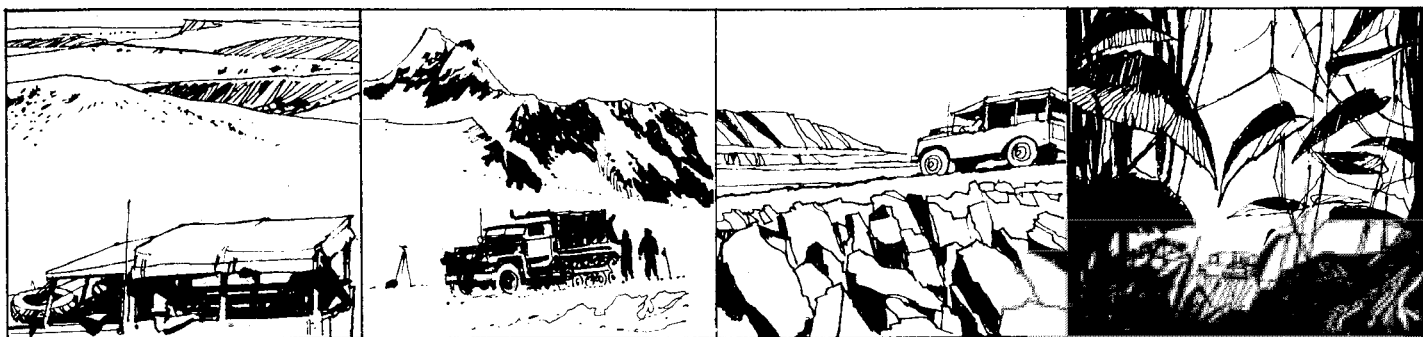

Pye Telecommunications Limited, Cambridge, England.  
Telephone: 0223 61222 Telex: 81166

WW—021 FOR FURTHER DETAILS

# OSCILLOSCOPE USERS

## here is the answer to your calibration problems!

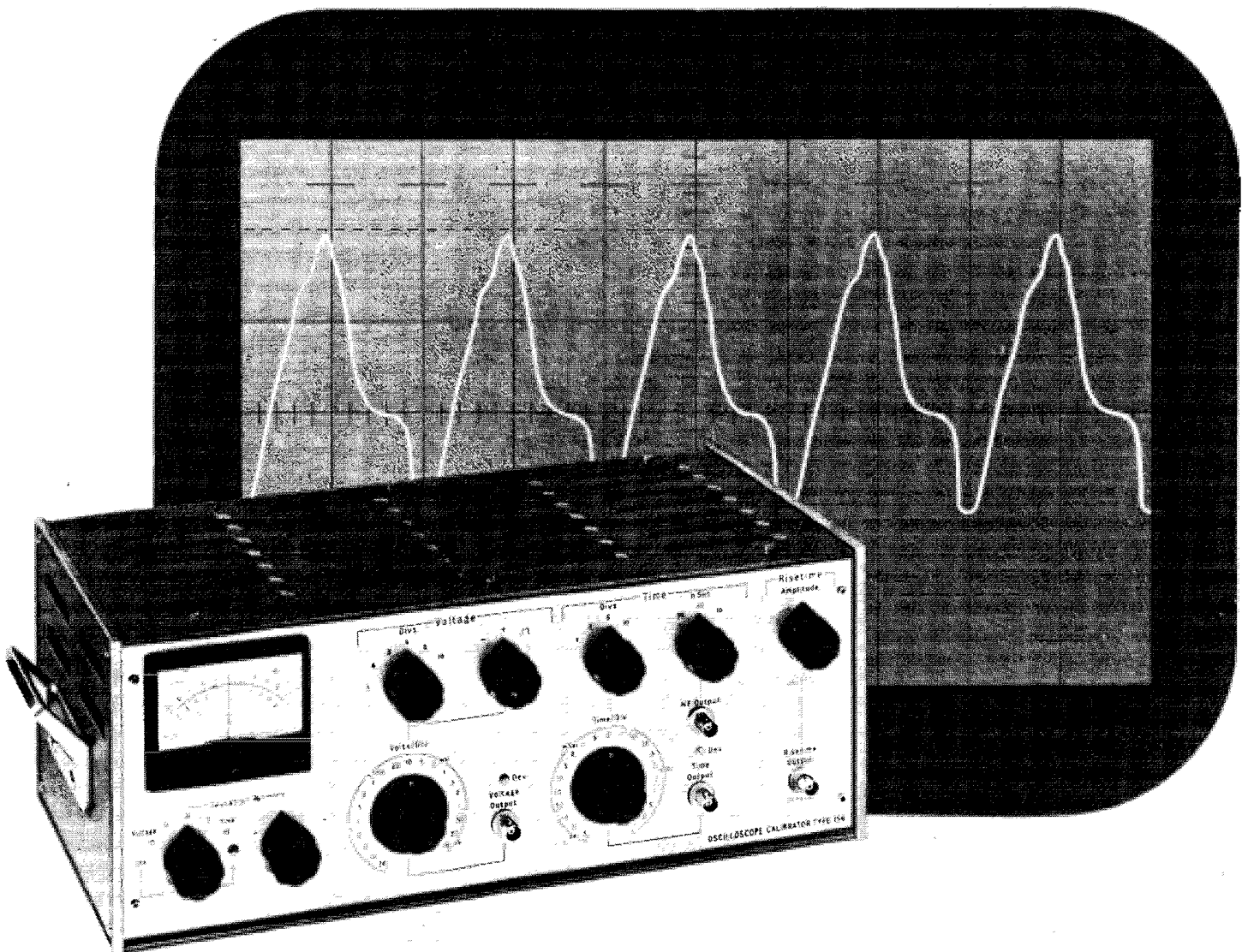

A new instrument, the BRADLEY Oscilloscope Calibrator 156 provides all the facilities required for the calibration of modern precision oscilloscopes. Simple to use, it is designed to calibrate vertical amplitude and sweep speeds, and to check risetime. A unique feature is the direct reading of percentage deviation from true values.

**BRADLEY** INSTRUMENTS

**G. & E. BRADLEY LTD**

ELECTRAL HOUSE, NEASDEN LANE, LONDON, N.W.10.  
TELEPHONE: 01-450 7811 TELEX: 25583

WW—022 FOR FURTHER DETAILS

# NOW

## design engineers can have

# 50 ppm TC $\pm 0.5\%$ tolerance

## -off the shelf!

Give us a ring, and you can have new Filmet® resistors in development quantities as soon as the postman can get them to you.

The new standard Filmet range meets all the requirements of DEF 5115-1 Style RFG7... and at a price that certainly isn't standard for the kind of stability it offers. But this you'll find out for yourself. When you ring, or write.

Resistance range: 100Ω to 360 KΩ, E24 series

Power rating:  $\frac{1}{8}w$ ,  $\frac{1}{4}w$ ,  $\frac{1}{2}w$  Multi-Rating

Temperature range:  $-55^{\circ}C$  to  $+125^{\circ}C$

# FILMET

metal film resistors

 **Morgan**

**MORGANITE RESISTORS LIMITED**

Bede Industrial Estate, Jarrow, County Durham  
Telephone: Jarrow 897771 Telex: 53353



Please send me full details of the standard Filmet range.

Name: \_\_\_\_\_  
Position: \_\_\_\_\_  
Company: \_\_\_\_\_  
Address: \_\_\_\_\_  
W.W.J.

WW-023 FOR FURTHER DETAILS

**CHOSEN FOR VITAL CIVIL AND MILITARY  
ROLES BY OVER FORTY GOVERNMENTS  
THROUGHOUT THE WORLD —**

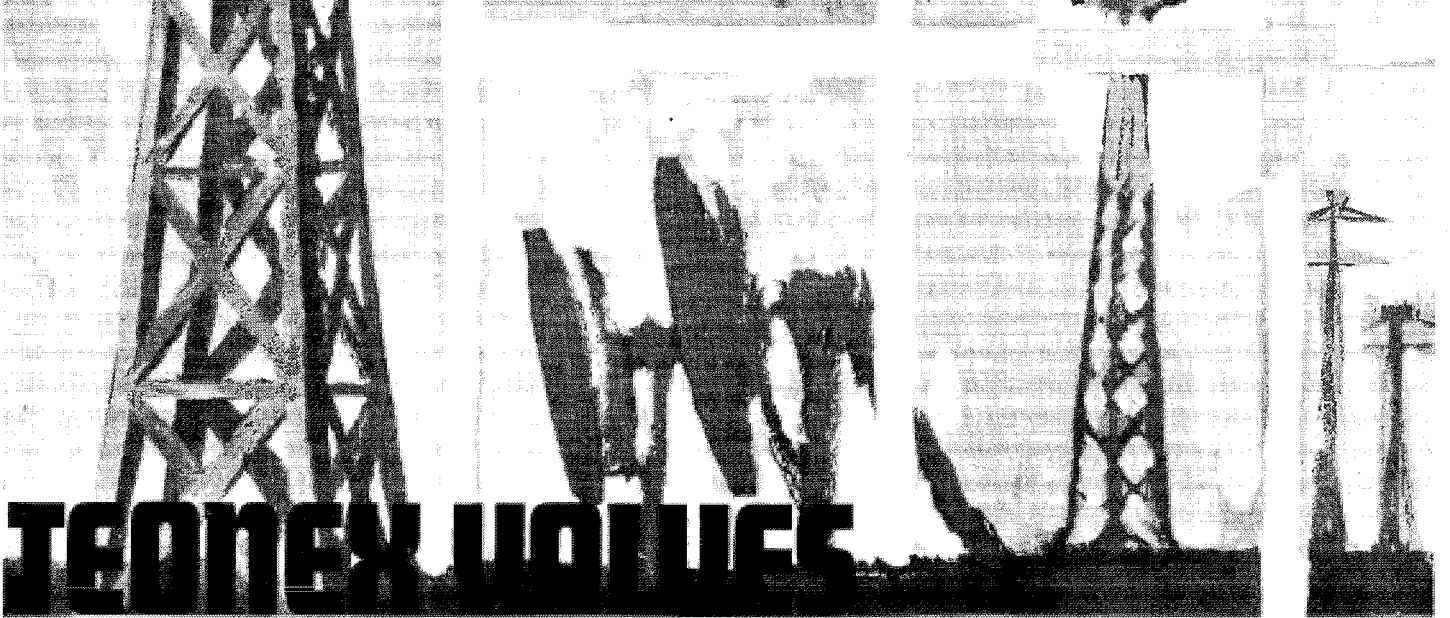

**TEONEX VALVES**

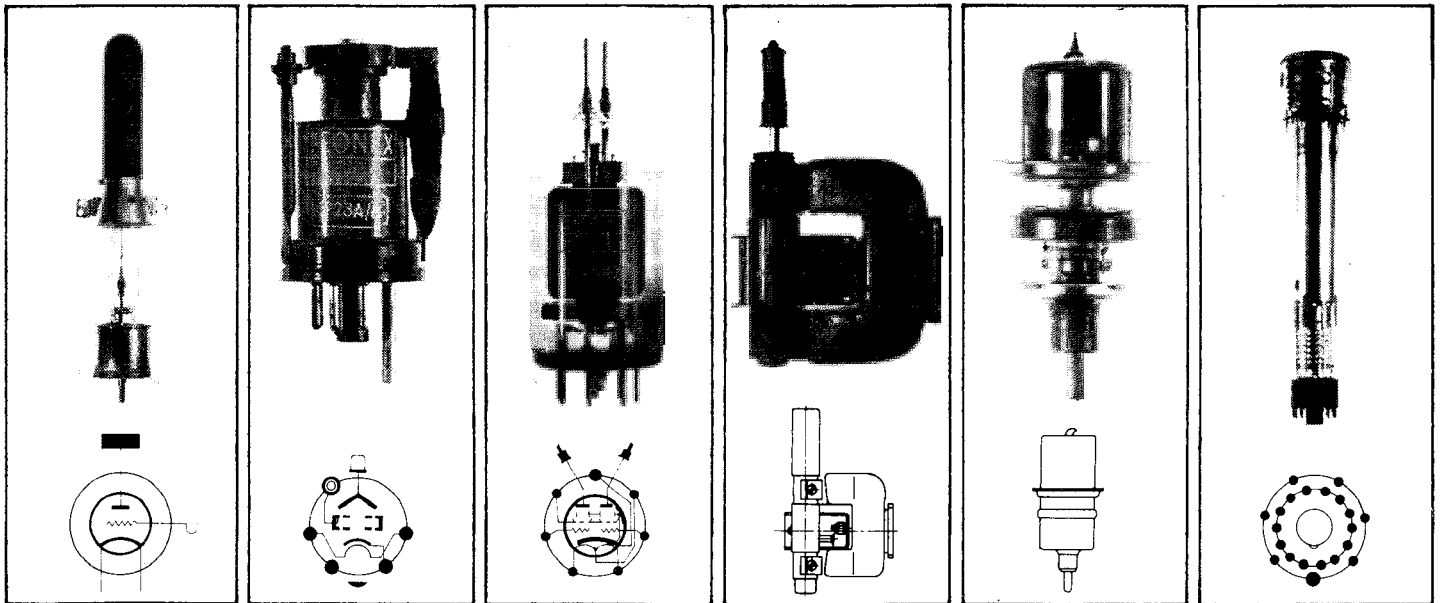

The same safeguards in manufacture and control that have won government contracts for TEONEX in over forty different countries apply equally to ensure top quality for private users too. When you require valves to comply with E.V.S. or M.I.L. standards — choose TEONEX.

The TEONEX range (for use outside the U.K. only) incorporates the entire series of British-produced valves or their Continental equivalents, including a wide range of colour T.V. valves. Price list and technical specifications may be obtained from:-

**Export Enquiries Only Please!**

**TEONEX LIMITED**



2a, Westbourne Grove Mews,  
London, W.11  
England.

WW—024 FOR FURTHER DETAILS

# High Fidelity

—the name is

# Goodmans

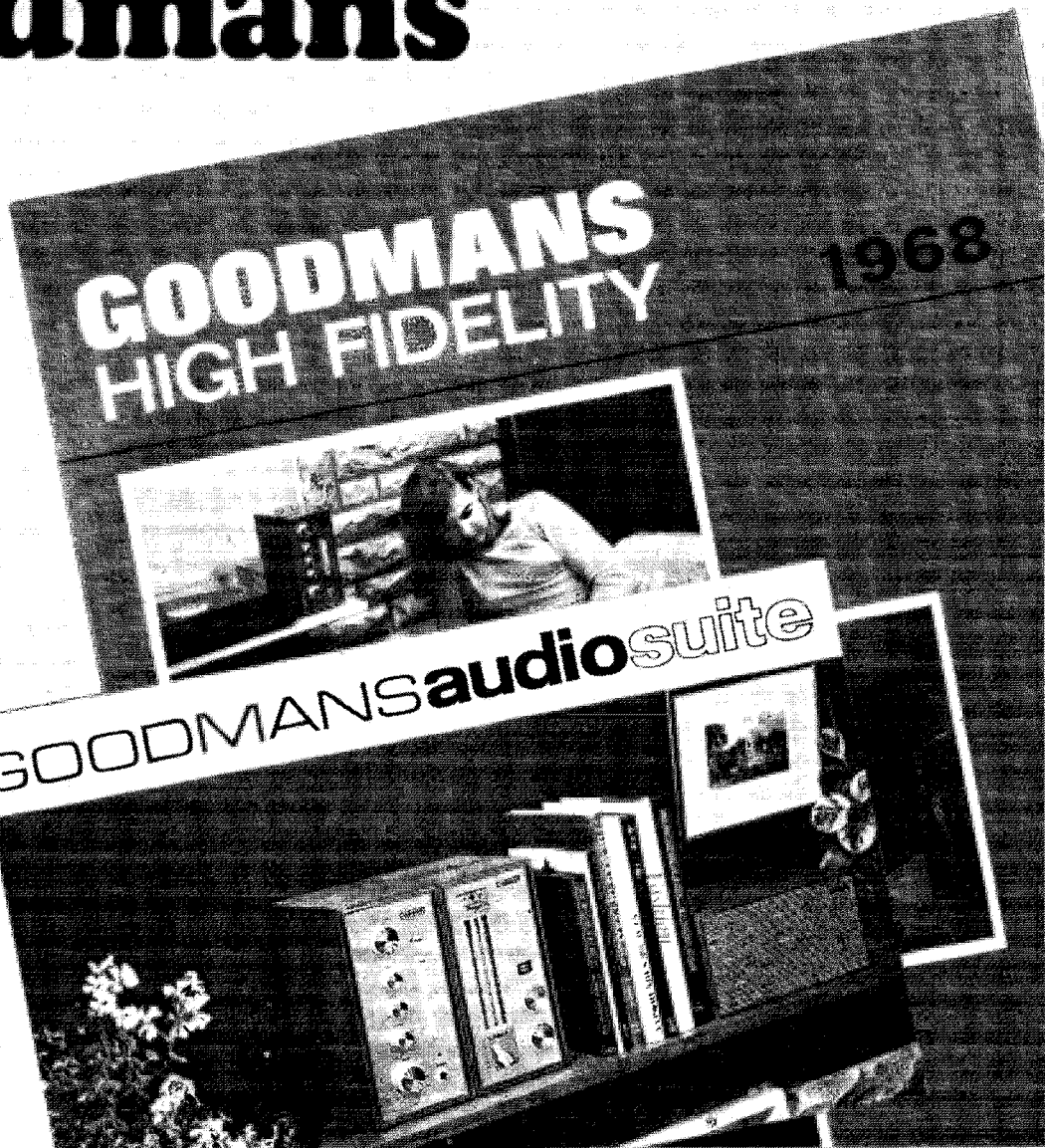

**and these publications tell you all about Goodman's High Fidelity**

## The High Fidelity Manual

Explains all about High Fidelity and the "mysteries" of Stereo and, of course, gives fullest information on all Goodman's High Fidelity equipment. Enclosure drawings are included for all single and multiple unit loudspeaker systems, so the D.I.Y. enthusiast can make his own, or they can be bought ready-made from manufacturers we recommend.

Goodmans amplifier, tuner, record player and range of complete loudspeaker systems are there in detail. If you're interested - or are becoming interested - in High Fidelity, you'll find the Goodman's Manual 28 pages of interesting and informative reading. Send for your free copy.

## Goodmans Loudspeakers Limited

Axiom Works, Wembley, Middlesex. Telephone: 01-902 1200

## The Audio Suite Booklet

Features in full colour the most compact, adaptable, handsome *and* the most technically advanced audio system in the world. Easily installed—in minutes—to suit your home; Simplicity itself to operate—Goodmans Audio Suite is *the* High Fidelity system. If this is what you want, just send for the Audio Suite booklet.

Please send me a **free** copy of:

- Goodman's High Fidelity Manual  
 Goodman's Audio Suite Booklet  
 (tick which required)

Name.....

Address.....

ww 6

WW—025 FOR FURTHER DETAILS

# New from Garrard—the AP 75 a high-fidelity single record-playing unit for less than £23\*

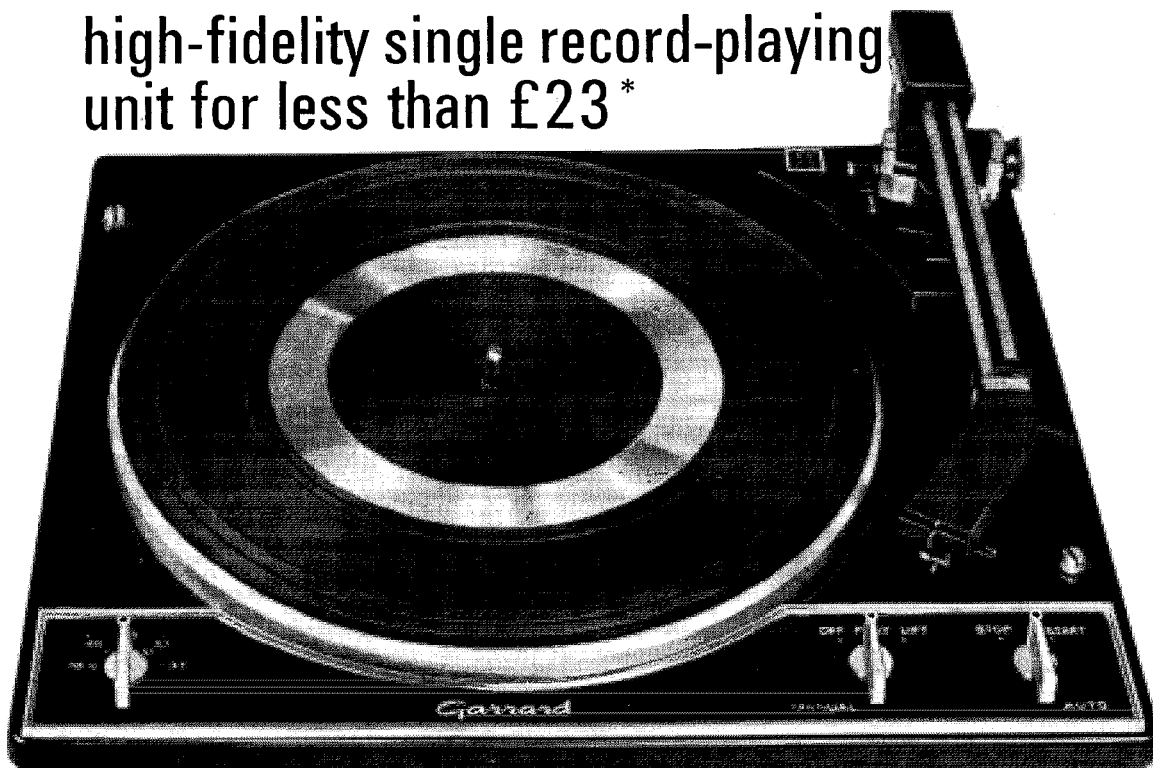

*You get all these advanced features with this elegant unit:*

- Diecast aluminium pick-up arm.
- Manual or automatic playing of single records.
- Single lever selects *both* record size and turntable speed.
- Slide-in cartridge carrier.
- Non-magnetic turntable.
- Calibrated, fine stylus-force adjustment.
- Calibrated pick-up arm bias compensation.
- Cue and pause facility.

As well as manual control, this unit offers the additional facility of automatic play of single records. A single operation starts the turntable, lifts the pick-up arm and lowers it on to the record, and when playing is finished, returns the pick-up arm to rest and stops the turntable. A single control lever selects both record size and turntable speed for 12" records (78 rpm), 7" (45 rpm) and 12", 10" and 7" (33 $\frac{1}{3}$  rpm). \*£19.3.0d. + P.T. 68/6d. Optional extras: teak-finish base WB4; rigid, clear plastic cover SPC4.

## and just for the record



**Garrard 401** is the ultimate in transcription turntables—magnetically shielded 4-pole induction motor; gear-cut stroboscopic markings illuminated by an integral, high-intensity neon lamp; variable speed control; heavy non-magnetic diecast turntable; anti-static mat; functional styling. \*£25.9.7d. + P.T. 91/2d.



**Garrard LAB 80 Mk II** is a transcription turntable with the facilities of an automatic record changer when desired—low resonance wood pick-up arm; pick-up arm bias compensator; calibrated, fine stylus-force adjustment; record-repeat adaptor; automatic play of single records, cue and pause facility. \*£25.15.1d. + P.T. 92/1d. Optional extras: teak-finish base WB2; rigid, clear plastic cover SPC2.

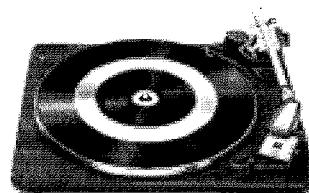

**Garrard SP 25 Mk II** a single-record playing unit giving exceptional performance at moderate cost. With pick-up arm bias compensator and calibrated, fine stylus-force adjustment. Cue-and-pause control allows pick-up to be raised or lowered at any point. \*£12.10.8d. + P.T. 44/10d. Optional extras: teak-finish base WB1; rigid, clear plastic cover SPC1.

*\*Recommended retail prices.  
(Subject to Budget revision 19/3/68.)*



# Garrard

looks after your records

Ask for illustrated leaflets on the complete Garrard range.

GARRARD ENGINEERING LIMITED, NEWCASTLE STREET, SWINDON, WILTSHIRE, ENGLAND. TELEPHONE: SWINDON 5381



© G 194

WW—026 FOR FURTHER DETAILS



# When specifications are all important!



## Broadcast standard magnetic tape recorders

Developed over a period of 15 years to meet the requirements of the Broadcaster, Recording Studios, Governmental Departments, the Services and other professional users the range of magnetic tape recorder equipment includes professional console and transportable tape recorders, reel-to-reel replay units, endless loop cartridge tape recorders, hi-speed tape copiers and automatic tape programming equipment. Unexcelled professional facilities are offered for master recording and editing. High performance and maximum reliability under heavy duty conditions is assured with silicon solid state electronics and modular construction techniques allowing fast change-over of complete, pre-aligned modules for maintenance purposes. Ask for operating details and specifications.

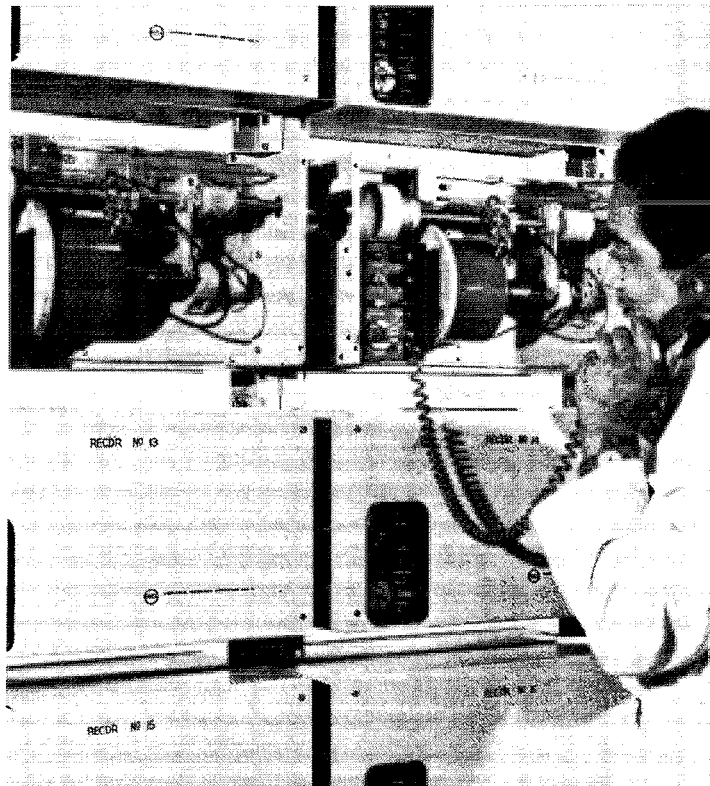

## Telecommunication grade magnetic drum announcement equipment

This heavy duty equipment is designed to provide telephone subscribers with a wide range of advice and information services. The equipment includes multi-channel Exchange Interceptors for automatic interception and advice to callers when changed numbers or non-working lines are dialled. Variable Message Repeaters for news, weather, sporting results and other information services of up to 3 minutes' duration—with immediate recycling at the end of the message, and economical short duration Auto Announcers for location or fault identification. The completely automatic equipment relieves telephonists of routine enquiry calls, yet provides subscribers with continuous, up-to-the-minute information services operating 24 hours a day. Complete details are available.



## PLESSEY

Sales and Service — Technical Ceramics Limited Cheney Manor Trading Estate Swindon Wiltshire Telephone Swindon (OSW3)6251 Telex 44375 Cable PIEZO Swindon or the manufacturer Plessey Components Australia Rola Unit The Boulevard Richmond Australia 3121 Telex 30383 Cables ROLA Melbourne

WW—027 FOR FURTHER DETAILS

AC86

# ♣ Technicians Marvel Over The Complete Perfection



## Model JR-500SE CRYSTAL CONTROL TYPE DOUBLE CONVERSION COMMUNICATION RECEIVER

- \* Superior stability performance is obtained by the use of a crystal controlled first local oscillator and also, a VFO type 2nd oscillator.
- \* Frequency Range: 3.5 MHz—29.7 MHz (7 Bands)
- \* Hi-Sensitivity: 1.5 $\mu$ V for 10 dB S/N Ratio (at 14 MHz)
- \* Hi-Selectivity:  $\pm 2$  KHz at  $-6$  dB  $\pm 6$  KHz at  $-60$  dB
- \* Dimensions: Width 13", Height 7", Depth 10".

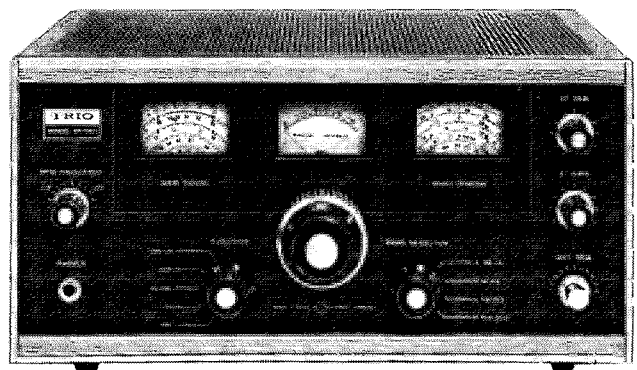

## Model 9R-59DE BUILT IN MECHANICAL FILTER 8 TUBES COMMUNICATION RECEIVER

- \* Continuous coverage from 550 KHz to 30 MHz and direct reading dial on amateur bands.
- \* A mechanical filter enabling superb selectivity with ordinary IF transformers.
- \* Frequency Range: 550 KHz to 30 MHz (4 Bands)
- \* Sensitivity: 2 $\mu$ V for 10 dB S/N Ratio (at 10 MHz)
- \* Selectivity:  $\pm 5$  KHz at  $-60$ dB ( $\pm 1.3$  KHz at  $-6$ dB) When use the Mechanical Filter
- \* Dimensions: Width 15", Height 7", Depth 10".

# TRIO

a product of TRIO Corporation, Tokyo, Japan.

Sole Agent for the U.K.

**B. H. MORRIS & CO., (RADIO) LTD.**

84/88, Nelson Street, Tower Hamlets, London E, 1. Phone: 01-790 4824

TO: B.H. Morris & Co., (Radio) Ltd. WW

Send me information on TRIO COMMUNICATION  
RECEIVERS & name of nearest TRIO retailer.

NAME : \_\_\_\_\_

ADDRESS : \_\_\_\_\_

WW—028 FOR FURTHER DETAILS

# Pinnacle the largest single valve independent

## THIS IS WHAT WE DO

Make available the widest range of valves for commercial and industrial use. Give a personalised service based on intelligence and speed.

Ensure that we only Supply valves made by the world's foremost manufacturers.

Provide valves selected for your special needs.

Help out rapidly with that "awkward" valve that nobody else seems to have heard of.

Specialise in European or American types which are not normally easily obtainable.

Rush you a small order, or quote for a bulk requirement—1's or 1,000's are all the same to us.

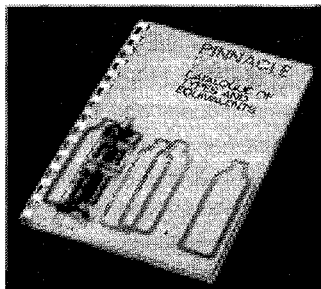
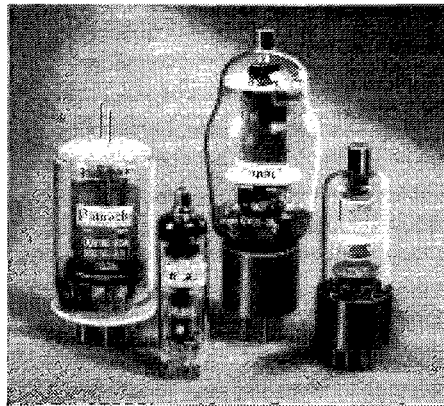

### IF I'D ONLY TRIED PINNACLE FIRST...

Every valve in either widespread or specialised use in the fields of Entertainment, Industry, Education and Research will be found in our catalogue, together with its main equivalents, classification, and the Pinnacle "P" number under which it may be ordered.

# Pinnacle

**PINNACLE ELECTRONICS LIMITED** ACHILLES STREET · NEW CROSS · LONDON S.E.14

Telephone: All Departments—01-692 7285 Direct orders—01-692 7714

# we don't believe in job selection for resistors



We make them the way we want them to be — first time! The Electrosil automated process produces the resistors we want — to the specified tolerance and value, off the line. We don't have to test and sort. The process is continuous and accurate. This way, you save. Because we are not manufacturing 'rejects', production costs are less, so is our selling price. You'll also find that the reliability we build in, saves you complicated test procedures and consequent costs. Glass-tin-oxide resistor reliability stems from better thinking in both materials and production techniques. Follow the leader in resistor design, it will pay off! All Electrosil resistors are triple-rated — this means you can have the resistor you want for the job, without worrying about job selection either. Data sheets quickly available from Electrosil tell you all, but briefly, right down to 50 parts per million temperature coefficient, you couldn't do better. This is no filmy philosophy, but hard (oxide hard) fact which we can back.

**you need**

**oxide reliability**

Electrosil Limited, P.O. Box No 37,  
Pallion, Sunderland, Co. Durham.  
Telephone, Sunderland 71481. Telex 53273



# MOSFET + BIPOLAR TRANSISTOR

LINEAR MONOLITHIC  
INTEGRATED CIRCUIT

## TAA 320

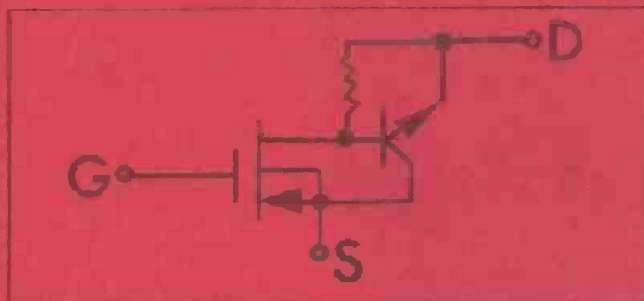

- Input Resistance  $10^{10} \Omega$
- Transconductance 40 mmhos
- Input Transients 100 V

Applications:

- Audio-amplifier (preamp and driver)
- Impedance-Converter
- Timing Circuits

# only 8/-

Prices in quantities of 100 and up

PRICES:

- 1-24 9/10
- 25 up 8/11
- 100 up 8/-

Please ask for detailed datasheets

### RASTRA ELECTRONICS LTD.

275 KINGSTREET • HAMMERSMITH • LONDON • W.6. • RIVerside 3143 • TELEX 24 443

WW-031 FOR FURTHER DETAILS

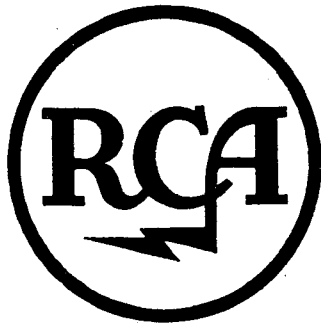

# RCA COLOUR TUBES

two totally unique advantages

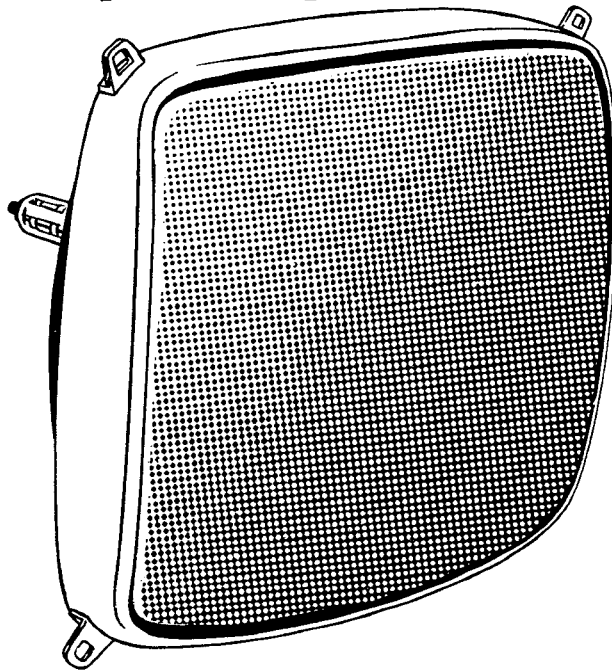

## New Rare Earth Red Phosphor

These new red phosphors—exclusive to RCA—combined with efficient sulphide blue and green phosphors produce pictures at their brightest and most dependable. They completely overcome the imbalance of the three guns which cause red blooming, colour fringing and failure of the red gun due to overwork. RCA's New Rare Earth Red Phosphor achieves UNITY CURRENT RATIOS—equal beam current from each electron gun; higher brightness, picture contrast and highlight; much longer tube life.

## Perma-Chrome

This is a four-point, temperature-compensated shadow mask assembly which accurately adjusts and sets the shadow mask position relative to the screen. Shadow mask expansion limits the performance of a rectangular colour-tube—Perma-Chrome renders this problem negligible. Perma-Chrome produces full-colour fidelity and temperature equilibrium throughout normal operation. It maintains excellent field purity and uniformity.

RCA 'HI-LITE' COLOUR PICTURE TUBES...

# THE BRIGHTEST IN THE INDUSTRY

For full technical specification and application information, write to:

RCA COLOUR TUBES LTD · PINFOLD PLACE · PIMBO · SKELMERSDALE · LANCS · TEL: TAWD VALE 4951

# Instead of illustrating a lot of meters you may not need let's just say Anders carry the largest stocks in the U.K.

And you can say that again! We have just compiled a catalogue\* and even we are surprised at the variety of standard and non-standard meters we offer for off-the-shelf delivery. Among them there is almost certain to be that meter you need in a hurry. It would be interesting (for both of us) to find out. It won't take a moment when you've got through to 01-387 9092 (By the way, for 'meter' read 'meters'... whenever the occasion demands).

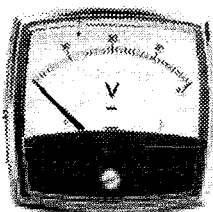
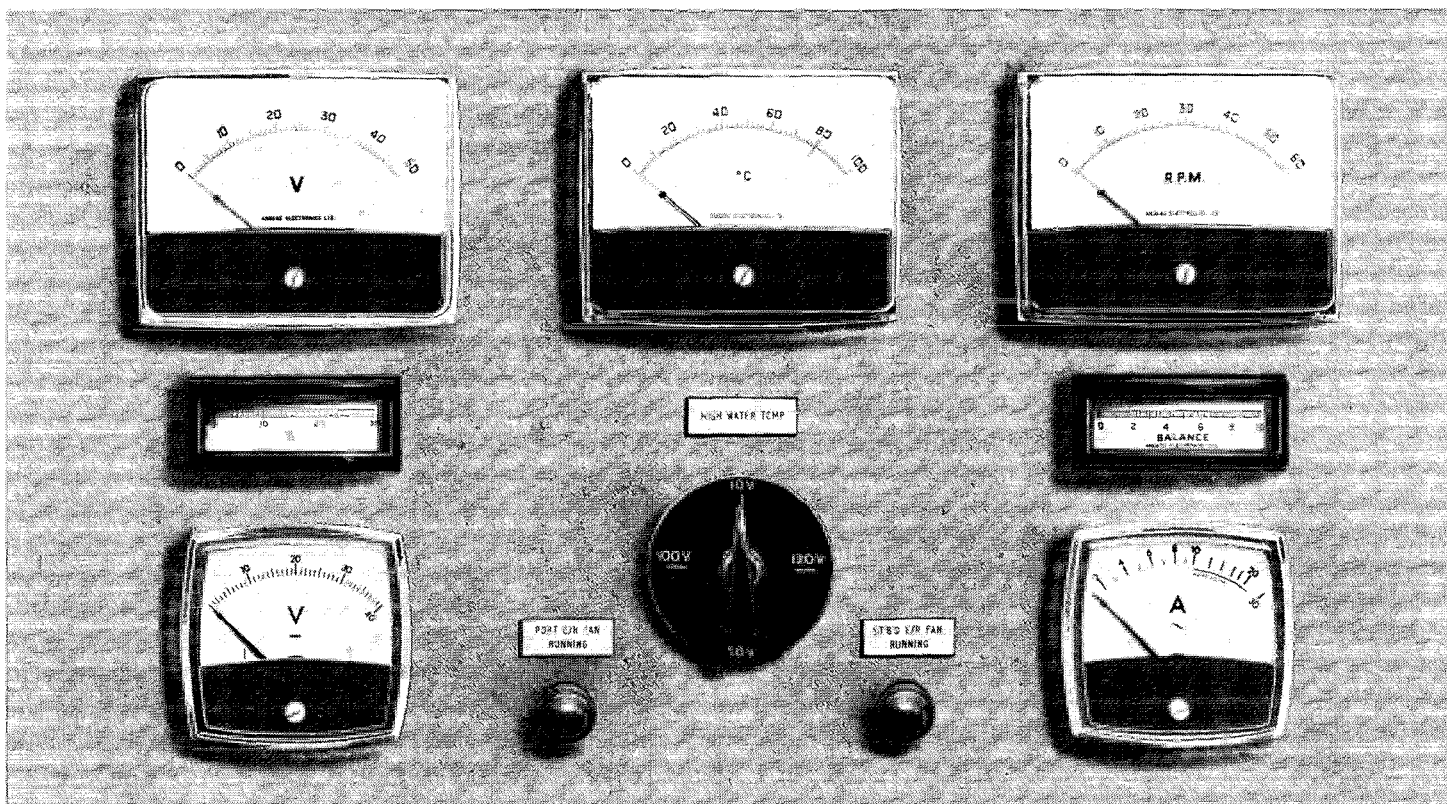

New TELEFRONT Series  
with clear plastic bezels

*\*We'll gladly send one to any manufacturer or bona-fide engineer.*

Manufacture and distribution of electrical measuring instruments and electronic equipment. The largest stocks in the U.K. for off-the-shelf delivery. Prompt supply of non-standard instruments and ancillaries. Sole U.K. distribution of FRAHM vibrating reed frequency meters and tachometers.

## ANDERS METER SERVICE

Anders Electronics Ltd · 48/56 Bayham Place · Bayham Street · London NW1 · Telephone 01-387 9092

WW—033 FOR FURTHER DETAILS

# Eddystone



## Amateur communications receivers

### EA12

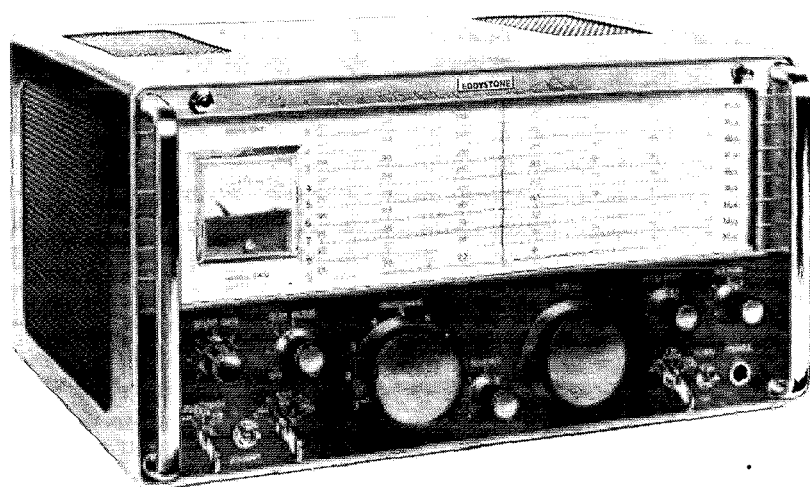

An amateur bands double-conversion superheterodyne receiver, for a.m, c.w, and s.s.b reception. For all amateur channels between 1.8 MHz and 30 MHz in nine 600 kHz bands with 28 MHz to 30 MHz in four bands.

**Primary features:** Crystal-controlled 1st oscillator, 2nd oscillator with continuously variable selectivity to 50 Hz, muting switched or by external relay, twin noise limiters, for a.m/c.w, and s.s.b, short-term drift better than 20 Hz and less than 100 Hz in any one hour, 'S' meter calibrated in nine levels of 6 dB and dB levels beyond 'S9', two a.g.c time constants, deep slot filter, independent r.f, i.f, and audio gain controls with outputs for f.s.k and panoramic adaptor.



### EC10 communications receiver

The fully transistorized EC10 communications receiver, supreme in its class, covers both medium-wave broadcasting and all shortwave service to 30 MHz. Incorporating the famous Eddystone tuning drive, with logging scale and auxiliary vernier, short-wave reception is particularly simple. Battery-operated or from optional a.c mains unit.

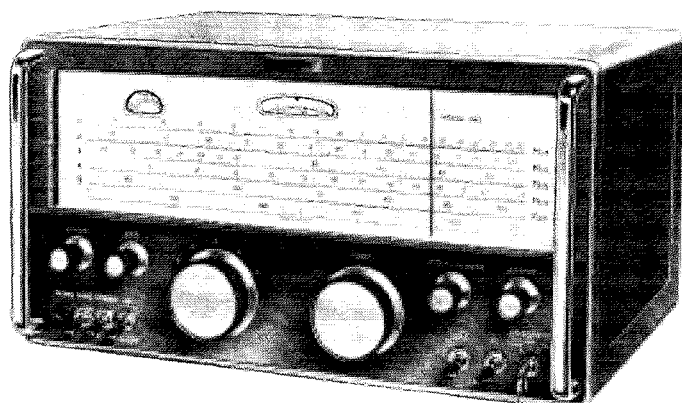

### 940 H.F communications receiver

An outstanding 13-valve receiver with two r.f and two i.f stages, silicon diode noise limiter circuit and high quality push-pull output. Built to a professional specification, facilities include provision for c.w, a.m, and s.s.b reception over the range of 480 kHz to 30 MHz in five bands. Suitable for 110/125 V and 200/250 V. 40-60 Hz a.c mains.

**Comprehensive information from your Eddystone distributor or: Eddystone Radio Limited, Eddystone Works, Alvechurch Road, Birmingham 31. Telephone: 021-475 2231. Telex: 33708.**

A MARCONI COMPANY

WW—034 FOR FURTHER DETAILS

LTD/ED551



“Where else can you buy a counter like this for £242?”

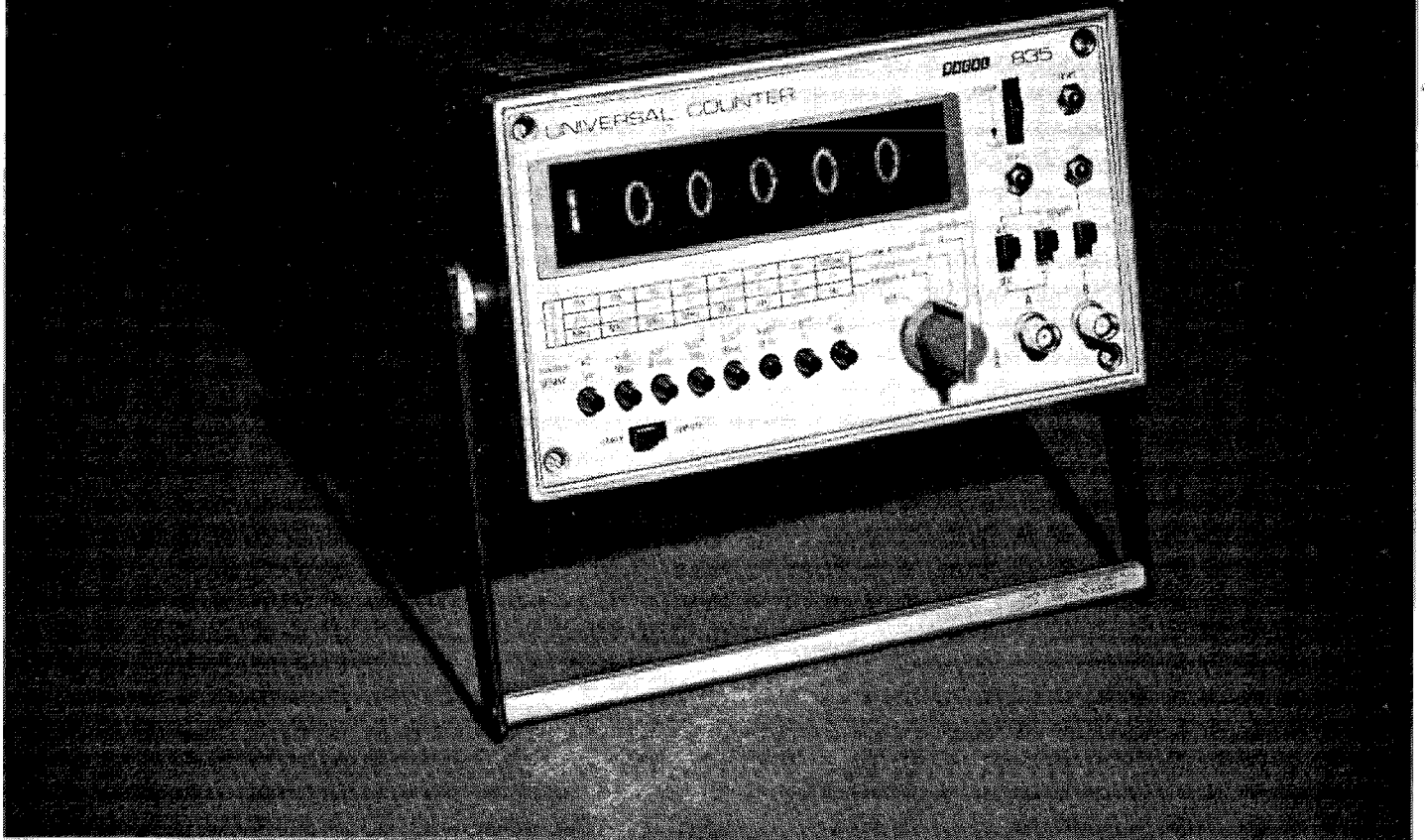

*£242. Price in U.K. only*

**Nowhere else.** The Racal type 835 Universal Counter/Timer provides Frequency, Period, Period Average, Ratio, Time Interval, Pulse Width and Mark/Space, Totalise and Scaling in one compact instrument.

Plus

- Integrated circuit construction
- DC to 12.5 MHz (125 MHz with Type 810 Divider)
- Sensitivity 75mV r.m.s.
- Gate Times 1  $\mu$ S to 10 Sec. (with push-button selection)
- Exceptionally easy to drive  
—tabular control information

Built to Racal 800 series standards, and occupying precisely half standard-rack width, the 835 has a companion Type 810 Frequency Divider which extends the frequency range to 125 MHz.

**RACAL  
INSTRUMENTS  
CUT COSTS**  
  
**NOT  
PERFORMANCE**

Racal Instruments Ltd., Crowthorne, Berkshire, England.  
Tel: Crowthorne 5652. Telex 84166 Cables/Grams Racal Bracknell.

**RACAL**

WW—035 FOR FURTHER DETAILS

# Performance. Reliability. Value.

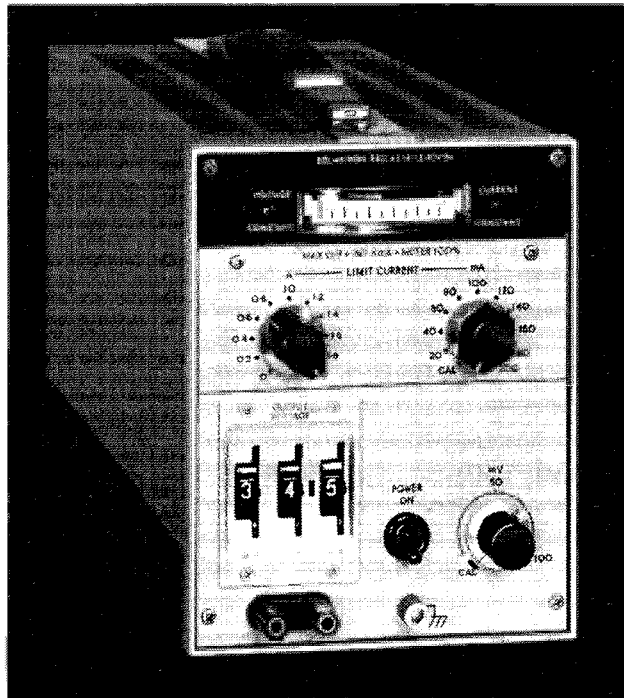

## The latest AS1410.2 Series power supplies – from Solartron.

Rugged and almost indestructible in use the AS1410.2 series power supplies have a more advanced specification than any other power supply unit available, and a performance approaching that of calibration standards.

In no other supply unit can you have all these facilities:

- Automatic constant voltage *or* constant current with stability ratio of 10,000:1.
- Remote programming and remote control of *all* functions with pinpoint remote resetting accuracy.
- 1% digital voltage setting with smooth control. Long-term stability of 0.05% in 1,000 hours.
- Ripple and noise less than 200  $\mu$ Vrms. Temperature co-efficient less than 0.01% per degree C.

If you don't need such facilities just remember you certainly want reliability and value against that precious appropriation.

## ASK SOLARTRON



**France**  
Societe D'Instrumentation,  
Schlumberger, Diffusion  
Commerciale, 241 Avenue  
Gambetta, Paris 20eme.



**Italy**  
Schlumberger Italiana Spa,  
Divisione Strumentazione,  
via Veniero 7, Milano.



**West Germany**  
Schlumberger (Overseas),  
Mesagerebau und Vertrieb Gmbh.  
8000 Muehen 15, Bayerstrasse 13.



**Switzerland**  
Schlumberger Messgerate AG,  
Badenerstrasse 333, 8040 Zurich.



**Sweden**  
Schlumberger Svenska AB,  
Vesslevagen 2-4, Lidingo 1.



**Austria**  
Schlumberger Overseas  
GES. M.B.H., A 1120 Vienna,  
Twoligasse 74/8.

**Australia** The Solartron Electronic Group Ltd., P.O. Box 138, Kew, Victoria

In addition there are 68 agents in territories throughout the world.



The Solartron Electronic Group Limited, Farnborough, Hampshire, England.  
Telephone: 44433 *A member of the Schlumberger Group*

# JACKSON

## THE BIG NAME IN PRECISION COMPONENTS

### TETFER VARIABLE CAPACITOR



- ★ Miniature  $\frac{3}{16}$  in. square, .5 maximum height.
- ★ Low loss P.T.F.E. dielectric.
- ★ 1500 V test.
- ★ Low temperature co-efficient.
- ★ Adjustable from above or below
- ★ Smooth ★ Easy ★ Precise ★ Multiturn
- ★ No locking required
- ★ 10pF swing, 2pF minimum
- ★ Low loss siliconed ceramic base
- ★ Has all the answers
- ★ More reliable than air.

### STAND-OFF INSULATORS

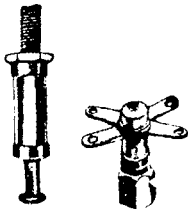

Jackson stand-off insulators are designed to perform well in rigorous environments. Their insulation resistance exceeds 20 million megohms even when atmospheric humidity is high. (They meet British Services test specification DEF5334.) They will withstand high steady voltages and intense r.f. fields. Forty different types: ask for catalogue.

- ★ Working voltages up to 10kV.
- ★ Stoved-on silicone treatment: water repellent.
- ★ Ceramic bodies.
- ★ Silver-plated tags.
- ★ No solder. No plastic. No adhesives.

### NEW FLEXIBLE SHAFT COUPLING



This new shaft coupling embodies the same well tried principles used in our Couplings. Only  $\frac{3}{16}$  in. diameter,  $\frac{3}{8}$  in. long, permits constant velocity coupling and mis-alignment of .005 in. and 15°. Robust too. Can take 15lbs in. torque.

### CORD DRIVE TYPE "D"

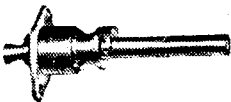

The Type D slow-motion drive finds many uses, as two-speed Cord Drive and, nowadays, as direct/slow drive for panel mounting.



**It's reliable if it's made by Jackson!**

Write for literature

**JACKSON BROS. (London) LTD.**

DEPT. W.W. KINGSWAY—WADDON  
CROYDON, CR9 4DG

Phone: Croydon 2754-5 (01-688) 'Grams: Walfilco, Croydon

# WIRELESS WORLD

## ENQUIRY SERVICE FOR PROFESSIONAL READERS

To obtain further details of any of the coded items mentioned in the Editorial or Advertisement pages of this issue, please complete one or more of the attached cards entering the reference number(s). Your enquiries will be passed on to the manufacturers concerned and you can expect to hear from them direct in due course. Cards posted from abroad require a stamp. **These Service Cards are valid for six months from the date of publication.**

**PLEASE USE CAPITAL LETTERS**

Pour obtenir tout renseignement complémentaire sur les produits mentionnés dans les articles ou dans les pages publicitaires de ce numéro nous vous prions de remplir une ou plusieurs des cartes ci-jointes en inscrivant le ou les numéros de référence. Vos demandes de renseignement seront transmises aux fabricants intéressés qui, en temps voulu, vous feront parvenir une réponse. Il est nécessaire d'affranchir les cartes postées à l'étranger. **Ces cartes de service sont valides pendant six mois à partir de la date de publication.**

**PRIÈRE D'ECRIRE EN LETTRES MAJUSCULES**

Weitere Einzelheiten über irgendwelche Artikel, die auf Radaktion-oder Anzeigen-seiten erscheinen, erhalten Sie, indem Sie eine oder mehrere der beigelegten Karten ausfüllen und die Kenn-nummer(n) angeben, Ihre Anfrage wird an den Hersteller weitergeleitet, und Sie werden dann direkt von ihm hören. Karten die im Ausland aufgegeben werden, müssen frankiert werden. **Diese Service-Karten sind sechs Monate vom Ausgabetag gültig.**

**BITTE IN BLOCKSCHRIFT AUSFÜLLEN**

Per ulteriori particolari in merito agli articoli menzionati nel testo o nelle pagine pubblicitarie di questo numero Vi preghiamo di completare una o più delle schede allegate citando il numero o i numeri di riferimento. La Vostra richiesta sarà inoltrata ai fabbricanti interessati che Vi risponderanno direttamente. Le schede dall'estero devono essere regolarmente affrancate. **Questo scontrino di servizio è valido per sei mesi dalla data di pubblicazione.**

**SI PREGA DI COMPILARE LE SCHEDE  
STAMPATELLO**

Con objeto de obtener más detalles de cualquiera de los artículos mencionados en las páginas editoriales o de anuncios de este número sírvase rellenar una o más de las unidas tarjetas citando el número o números de referencia. Sus consultas serán transmitidas a los fabricantes interesados de quines tendrán noticias directamente a su debido tiempo. Las tarjetas enviadas desde el extranjero requieren franqueo. **Estas tarjetas de servicio son validas durante 6 meses a partir de la fecha de publicación.**

**SÍRVASE ESCRIBIR CON LETRAS MAYUSCULAS**

# Audix

**TAILOR-MADE  
TO YOUR OWN  
REQUIREMENTS**

## CONTROL CONSOLES

The Audix range of audio control consoles has been designed to meet every requirement for sound reproduction in control rooms, theatres, lecture halls and public buildings. Each console is purpose built and can incorporate any of the wide range of specialised sound equipment manufactured by Audix. The quality of the cabinet work, superbly constructed and finished in solid hardwood, matches the high standard of workmanship found throughout our extensive range of standard and specially designed sound systems—the result of 21 years' experience in this highly specialised field. We shall be pleased to advise you on your particular requirements without obligation.

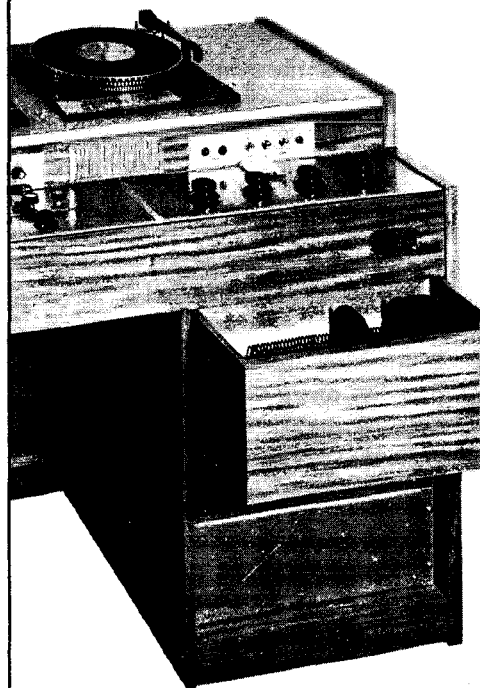

A specialised Discotheque console providing full fading, cueing and mixing facilities. The front panel can be either flush fitting in solid matt-finished timber or recessed in stylish illuminated gold panelling.

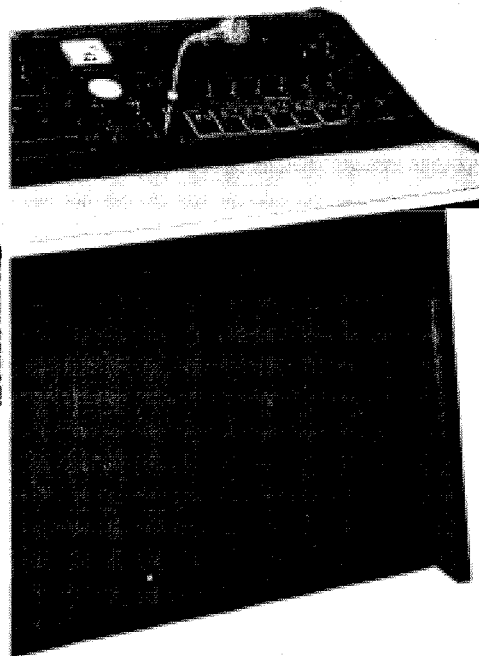

This is the most widely used of our consoles coupling flexibility of installation with ease of operation. It can be provided in widths of from 3 ft 6 ins. to 10 ft dependent on equipment requirements which may include record and tape decks—The assembly is based on the use of standard 19 ins. GPO panels.

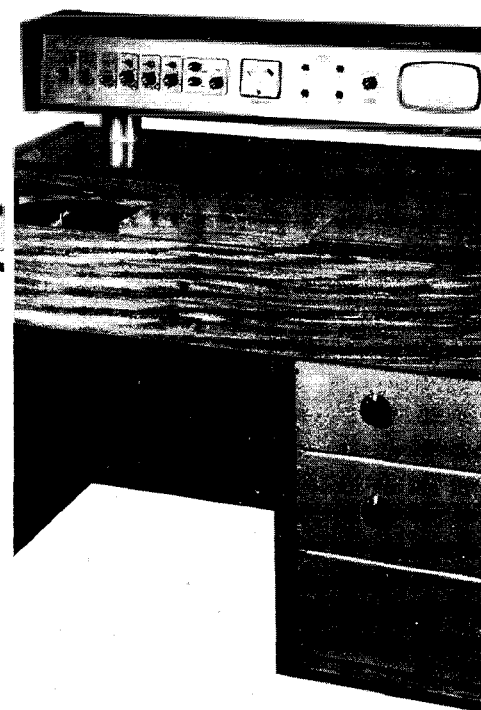

This console features a raised control panel and smooth sliding covers to the record or tape decks. Another example of the variety of console equipments that we can provide to meet your particular requirements.

**AUDIX SOUND SYSTEMS & ELECTRONICS STANSTED ESSEX**

**Telephone: STANSTED 3132/3437**

# TIMERS

# MICRO SWITCHES

IMMEDIATE DESPATCH

NEW

**Solid State Process Timer type TDS**

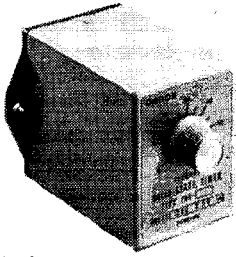

LATEST CIRCUIT PROVIDES PROLONGED ACCURACY

- 1% REPEAT ACCURACY
- OCTAL BASE PLUG-IN
- CIRCUIT CONTAINS BUILT-IN VOLTAGE STABILISER
- CONTACTS

Timed out 5 amp c/o  
Instantaneous 15 amp normally open  
30 sec and 60 sec Linear dials  
110 and 240 VAC operated  
Approximately £10 dependent on quantity

**SYS MINI-TIMER**

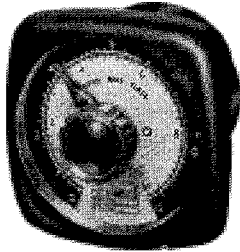

**SYNCHRONOUS MOTOR & CLUTCH**

- ★ 10 MILLION OPERATIONS
- ★ Instantaneous & Timed out 3 AMP contacts.
- ★ Repeat Accuracy  $\pm 1\frac{1}{2}\%$ . 10 secs to 28 Hrs. May also be used as impulse start and automatic reset.

£11.0.0 approx. dependent on quantity.

NEW



**TEMPERATURE CONTROLLER TYPE THP**

- THERMISTOR OPERATED
- OCTALBASE PLUG IN
- COMPACT

Temperature ranges up to 240°C  
Output contacts 4 amp  
Accuracy 2% full scale  
Complete with Thermistor  
Approximately £15 dependent on quantity

**AT-10 PNEUMATIC TIMER-relay**

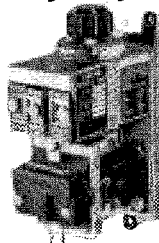

- ★ Fully adjustable up to 200 seconds. Fitted with 15 amp. S.P.D.T. switch.
- ★ One model provides delay after energise or delay after de-energise

approx. £7.0.0  
dependent on quantity.

**FLOATLESS LIQUID LEVEL CONTROL**

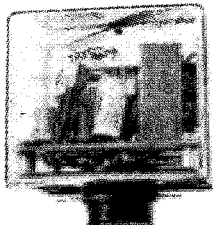

- ★ 5 amp. OUTPUT CONTROL CONTACTS
  - ★ Solid State
  - ★ Octal-Base plug-in
- The most compact unit available, measures only 2½" x 2½" x 3".

Approx. £4.0.0.

dependent on quantity.

SINGLE AND TREBLE STAINLESS ELECTRODES AVAILABLE.

**STP Sub-Mini Process Timer SYNCHRONOUS MOTOR & CLUTCH**



- Matchbox size frontal area. Automatic re-set.
- ★ PLUG-IN OCTAL BASE
  - ★ INSTANTANEOUS AND TIMED OUT 2 AMP CONTACTS
  - ★ RANGES: 10 SECS. TO 36 MINS.
- approx. £5.0.0 each.

**YL2 GPA**



**PROXIMITY SWITCH**

- ★ FOR BATCHING, CONVEYORS, MACHINE TOOL CONTROL, PACKAGING, SORTING, etc.
- ★ SENSES FERROUS OBJECTS
- ★ NEEDS NO MECHANICAL FORCE OR PRESSURE TO OPERATE
- ★ SOLID STATE SENSING HEAD INCLUDES CONSTANT VOLTAGE CIRCUIT
- ★ MAINS OPERATED

approx. £12.10.0 dependent on quantity.

OTHER INDUCTIVE AND CAPACITY TYPES AVAILABLE

**YL2 GPB**

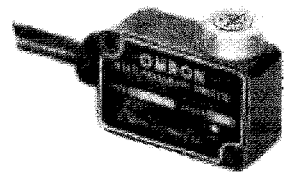

**S5G**



- ★ 1 MILLION OPS. 5 amp. c/o Sub-miniature Micro-switch.

2/6 each per 1,000

**VAQ**

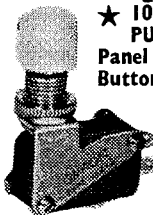

- ★ 10 amp. c/o PUSH BUTTON Panel mounting. Buttons in six colours.

4/4 each per 1,000.

**HEAVY DUTY PUSH-BUTTON SWITCHES**

7 different panel mounting actuators including; knob, key, and lever, as well as push on/push off. Up to 4 switch blocks can be fitted. Dust and splash proof, D/P slow make and break, 5 amp rating. Full literature on request.

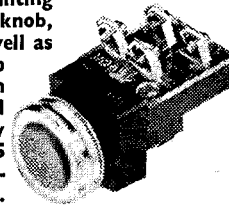

**VV-15-1A**



- ★ 15/10 AMPS. c/o
- ★ 100,000 ops.

1/11 each per 1,000  
Single Throw 1/6 each

**LIMIT SWITCH**

**WL 10 FNJ**

- ★ 10 AMP 2 CIRCUIT
- ★ 5 INCH FLEXIBLE ACTUATOR AS ILLUSTRATED

AS LOW AS 53/9 EACH.

FIVE OTHER STANDARD TYPES AVAILABLE

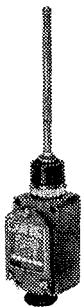

**V-10-1B**



- ★ 1 MILLION OPERATIONS.
- ★ 10 amp. c/o.
- ★ COMPARE OUR SPEC. & OUR PRICES WITH OTHER SIMILAR TYPES.

Screw Terms. 3/1 each per 1,000

V-10-1A Solder Tags 2/3 each per 1,000  
VV-15 IC2 187 Amp Tags 2/6 each per 1,000

NEW! Approx. 3/3 each per 1,000.

**GGR-5**



Light force wire operated Micro-switch  
Designed for even more economical coin operation mechanisms.

U.L. APPROVED (Appr. No. 32667)

U.S. MILITARY SPECIFICATION

List of Distributors: B.P.G. Ltd., Leicester 61460; Edmundsons Electronics Ltd., London, New X 9731; A. C. Farnell Ltd., Leeds 35111; Gordon Wilson Ltd., Blackburn 59921; G.D.S. Ltd., Bucks. Orchard Grove 694.

## OMRON PRECISION CONTROLS

(Dept. W.W.9)

OMRON LTD: 313 Edgware Road, London, W.2

Tel.: 01-723 2370

01-262-8584

WW-037 FOR FURTHER DETAILS

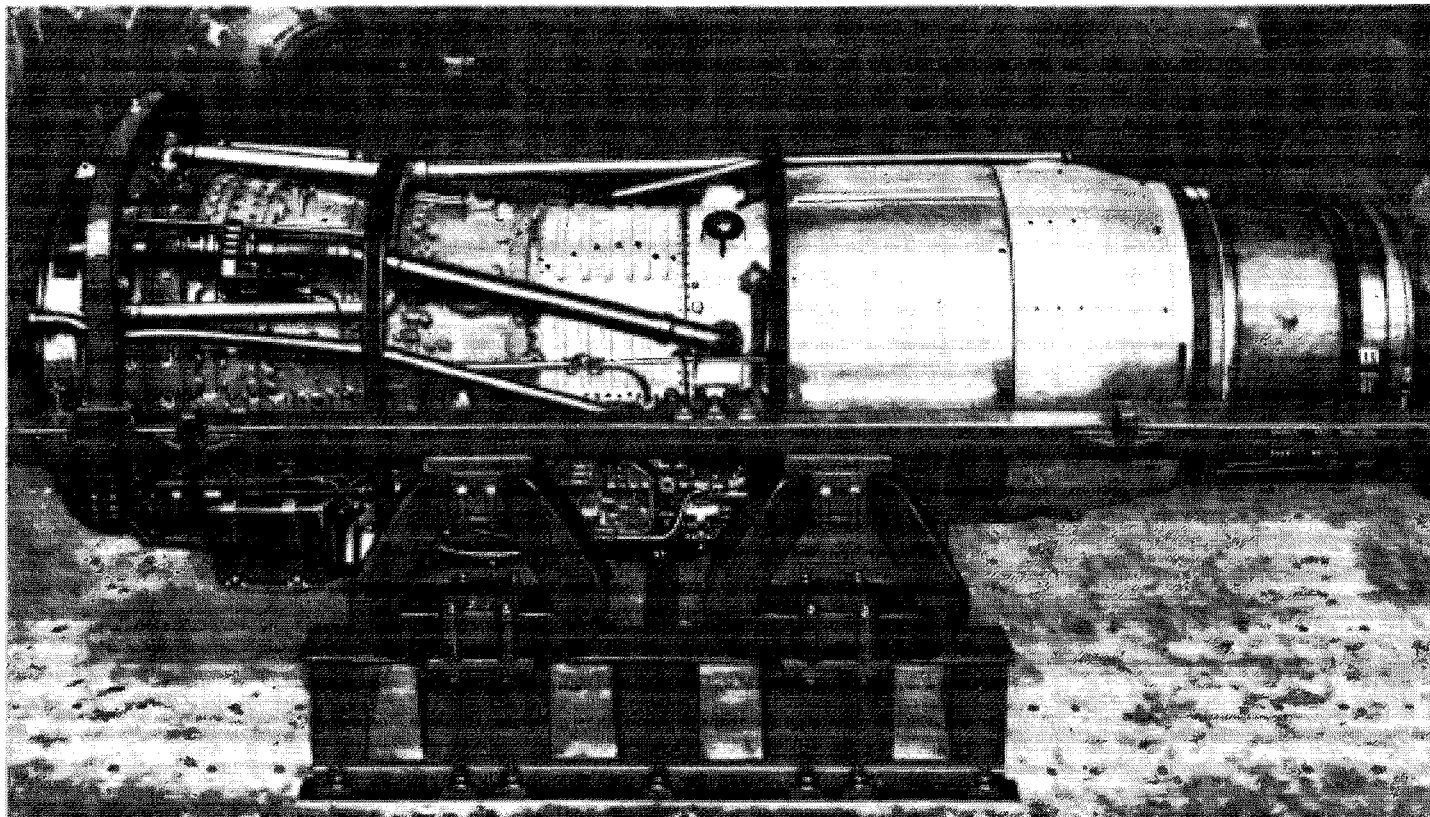

Photograph by courtesy of Bristol Siddeley Engines Ltd.



Silentbloc  
Delta Mountings  
designed to safeguard  
**precious cargoes**

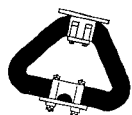

Silentbloc Delta Mountings were originally designed to protect heavy and delicate machinery from the hazards of road/rail/air transport. It is a far cry from this very complicated application to their use in fairground electric runabouts where passengers and equipment are protected from collision impacts.

Even under the most severe tests Delta Mountings control movement to pre-determined limits of travel while allowing sufficient flexibility to prevent damage to the protected apparatus.

If you, too, have an unusual shock problem why not consult our design engineers.

**SILENTBLOC**  
FLEXIBLE RUBBER MOUNTINGS

SILENTBLOC LIMITED · MANOR ROYAL · CRAWLEY · SUSSEX  
Telephone: Crawley 27733 Telegrams: Silentbloc Crawley Telex: 87177  
Andre Rubber Co. Ltd. is another Silentbloc Company.  
Silentbloc products are also manufactured by Silentbloc (Australia) Pty. Ltd. Melbourne.



# Coaxial Cables

from 3/8" to 3"

foam or air dielectric

with

# Connectors

available from stock.

Larger sizes to order.

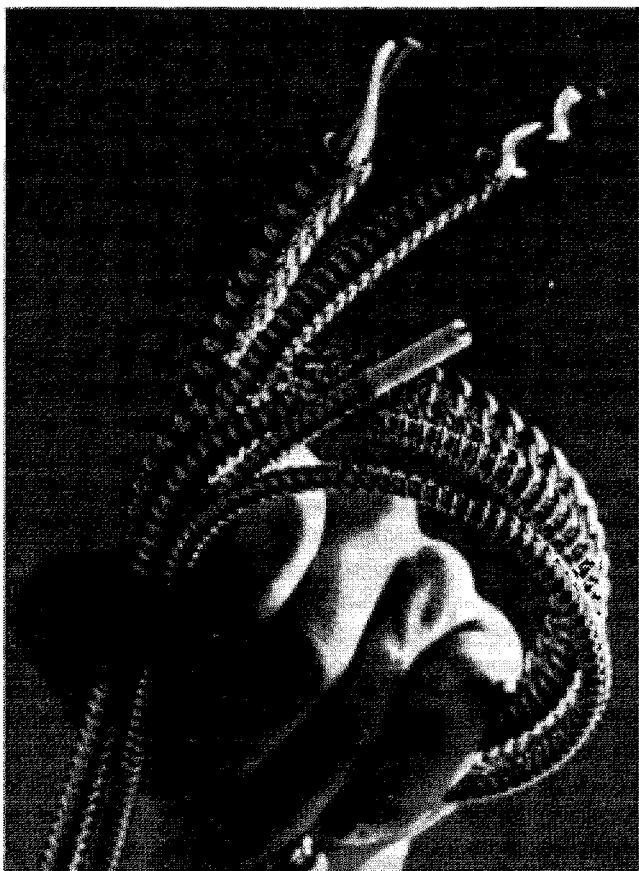

## ANDREW ANTENNA SYSTEMS

LOCHGELLY · FIFE

Tel. Lochgelly (059-278) 561

Telex 72491

AA-2B

WW-039 FOR FURTHER DETAILS

# CONTELEC

## TYPE 070 WIREWOUND ADJUSTMENT POTENTIOMETERS

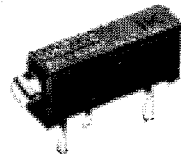

**NOW AVAILABLE  
AT 9'6 EACH  
FOR LARGE QUANTITIES  
Ex-stock delivery!**

A high quality sub-miniature, trimming potentiometer.  
Resistance Range  
10Ω to 20KΩ.  
Temperature  
Range  
-55°C to 150°C.

*Full details of these  
and other types from*

## W.GREENWOOD (LONDON) LTD.

21 GERMAIN STREET,  
CHESHAM, BUCKS

Chesham  
4808/9

WW-040 FOR FURTHER DETAILS

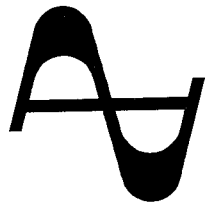

**Armstrong**  
the high fidelity sound

Compare an Armstrong  
with any tuner, amplifier  
or tuner-amplifier of even  
remotely comparable  
price and you will find the  
Armstrong is not only the  
best value but the best.

Start your comparison by  
sending the coupon for our  
complete catalogue or write  
mentioning 6WW68.

Armstrong Audio Limited  
Walters Road  
London N7  
telephone 01-607 3213

name _____
address _____
_____
_____
6WW68

WW—041 FOR FURTHER DETAILS



You  
could buy  
5 bridges

or one  
autobalance  
component bridge



The B421  
will measure...

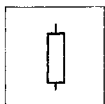

**RESISTORS**

from 0.01 ohm to 100 megohms, direct reading. Accuracy 0.25%.

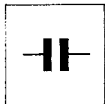

**CAPACITORS**

from 0.01 pF to 10 microfarads. Accuracy 0.25%. Push-button for instant reading of loss (shunt) resistance.

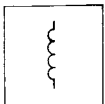

**INDUCTORS**

from 1 microhenry to 100 henrys. Accuracy 2%. Push-button for measurement of series resistance.

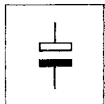

**ELECTROLYTICS**

10 microfarads to 10 000 microfarads with d.c. applied. Also leakage from 1 micro-amp to 10 milliamps.



**TOLERANCE**

from -25% to +25%, for L, C and R.

... in seconds



**THE WAYNE KERR  
COMPANY LIMITED**

NEW MALDEN □ SURREY □ ENGLAND  
TEL: 01-942 2202 □ TELEX 262333

WW-042 FOR FURTHER DETAILS

**WVG**

**NEW**

**SOLDER  
REMOVER**



Instantly removes  
unwanted solder from  
printed circuits and  
other joints. Saves  
time, increases pro-  
duction, eliminates  
risk of damage to  
components.

**79/6**

Available now from

**W.GREENWOOD  
INSTRUMENTS LTD**

**21 GERMAIN STREET,  
CHESHAM, BUCKS**

**Chesham  
4808/9**

WW-043 FOR FURTHER DETAILS

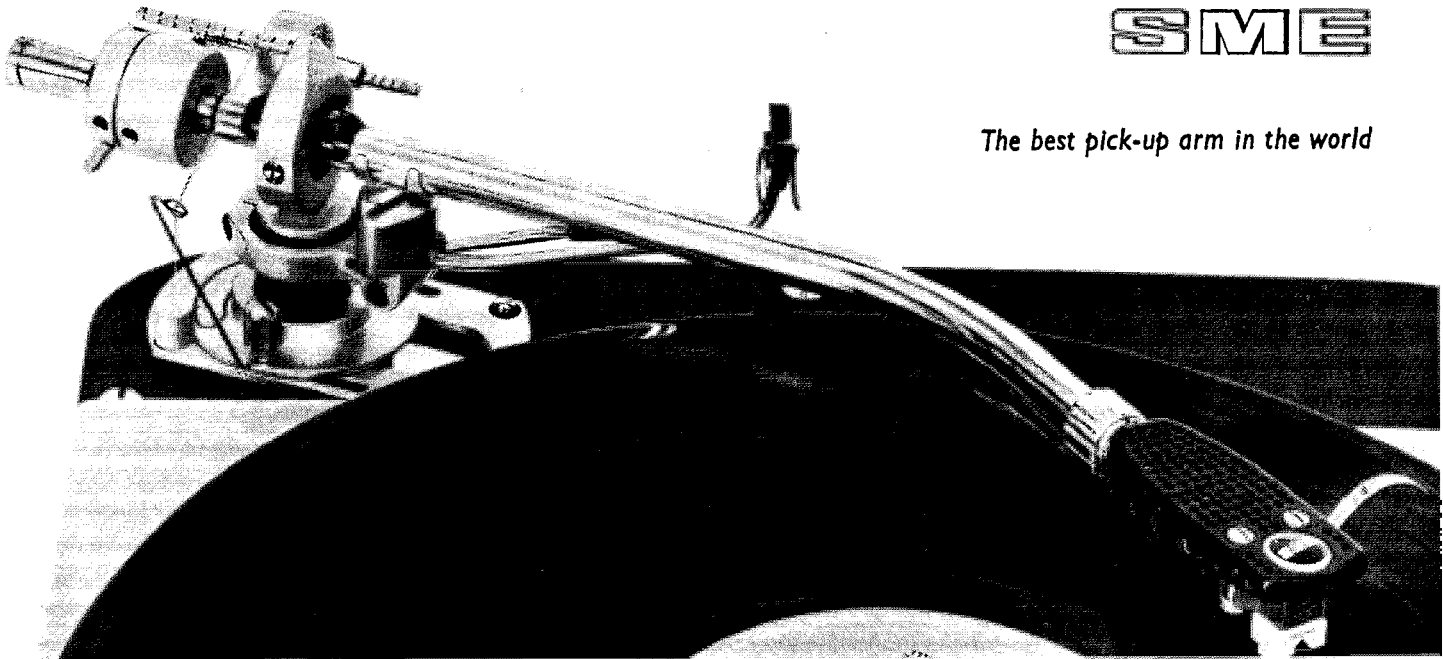
**SME***The best pick-up arm in the world*

Only S.M.E. Precision Pick-up Arms offer all these features · Choice of arm length Model 3009 (9in.) or Model 3012 (12in.) for still lower tracking error—of special importance with elliptical styli · low inertia · High precision ball races and knife-edge bearings for minimum pivot friction · Linear offset chosen for lowest distortion · Automatic slow-descent with hydraulic control · Bias adjuster calibrated for tracking force · Exact overhang adjustment with alignment protractor · Precise tracking force from  $\frac{1}{4}$ -5 grams applied without a gauge · Shielded output socket · Low capacity 4ft. connecting cable with quality plugs · Light-weight shell · Camera finish in satin chrome, gun-black and anodised alloy · Comprehensive instructions · Rational development—all improvements can be incorporated in any existing Series II arm.

*For sales and service ring Steyning 2228*

**S M E LIMITED · STEYNING · SUSSEX · ENGLAND**

WW-044 FOR FURTHER DETAILS

**NEW  
FROM**

**VERO**

**card frame system 3**

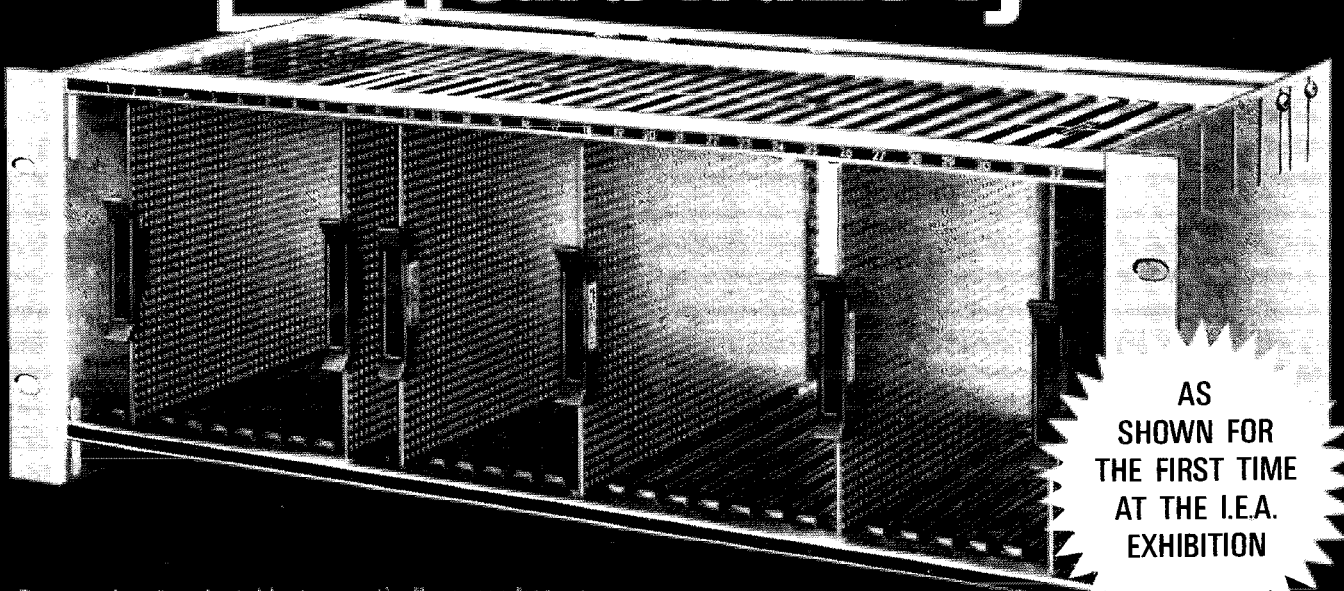

**AS  
SHOWN FOR  
THE FIRST TIME  
AT THE I.E.A.  
EXHIBITION**

A System that is adaptable to practically every known requirement — any size . . . any shape — with high temperature flame-resistant guide mouldings, which can be arranged to give any spacing between cards. Other features include built-in card identification facilities.

**VERO ELECTRONICS LTD.**

Industrial Estate, Chandlers Ford, Eastleigh, Hants. S05 3ZR.

Tel: Chandlers Ford 2921/4. Telex: 47551

**BRANCHES AND AGENTS THROUGHOUT THE WORLD**

# REPEAT PERFORMANCE FROM GARDNERS

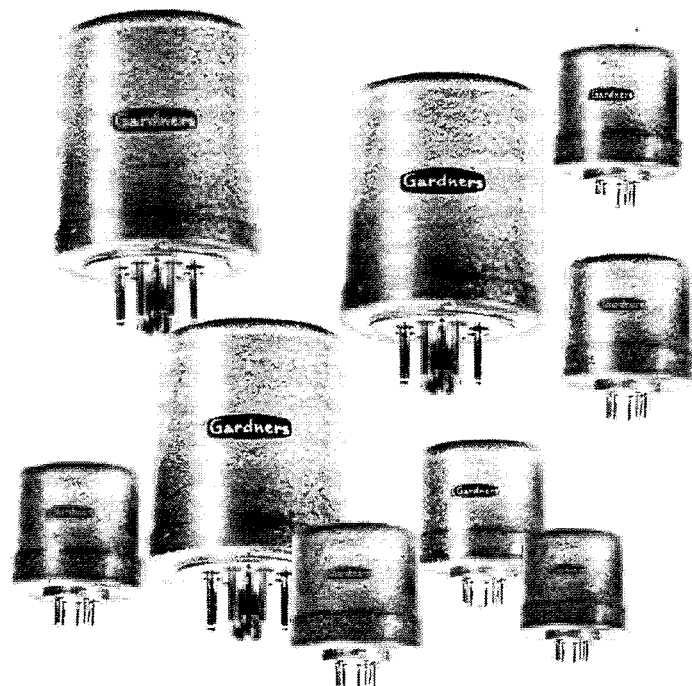

**Exceptionally wide band  
microphone and audio line  
matching transformers**

#### FREQUENCY RANGE

100 K.ohm models  $\pm 1$  dB 30 c/s to 20 kc/s.

All other models  $\pm 0.5$  dB 30 c/s to 20 kc/s.

**MAXIMUM AUDIO LEVEL** +12 dBm (16mW).

**INPUT IMPEDANCE** maintained to within  $\pm 10\%$  ( $\pm 20\%$  j) at all frequencies within the range 50 c/s to 8 kc/s (to 5 kc/s only for 100 K.ohm models).

**MAGNETICALLY SCREENED**

—50 dB reduction in hum pick up.

For professional recording and broadcast transmission equipment, these Octal-based plug-in transformers have a frequency response extending well beyond the audio range. The design achieves dynamic performance with minimum distortion at all levels

Type No.	Input Z Ohms	Pin Nos. †	Output Z Ohms	Pin Nos.	Sec./Pri. Turns Ratio	Applications
MU.7521	3-75/15*	1-3, 2-4	600 (C.T.)	6-7-8	6-32:1/12-64:1	Low Z. Mic/Line
MU.7522	3-75/15*	1-3, 2-4	100K.	6-8	82:1/164:1	Low Z. Mic/Grid
MU.7523	75/300*	1-3, 2-4	600 (C.T.)	6-7-8	1-41:1/2-82:1	Line/Line
MU.7524	150/600*	1-3, 2-4	600 (C.T.)	6-7-8	1:1/2:1	Mixing: Bal./Unbal.
MU.7525	600 (C.T.)	6-7-8	300/1.2K*	1-3, 2-4	1+1:1-41 (C.T.)	Mixing: Hybrid ‡
MU.7526	600 (C.T.)	6-7-8	2.5k/10k.*	1-3, 2-4	2-04:1/4-08:1	Line/Grid
MU.7527	150/600*	1-3, 2-4	100K.	6-8	13:1/26:1	Line/Grid
MU.7528	7.5/30*	1-3, 2-4	600 (C.T.)	6-7-8	4-47:1/8-94:1	Low Z. Mic./Line
MU.7529	50/200*	1-3, 2-4	600 (C.T.)	6-7-8	1-73:1/3-46:1	Mic. or Line/Line
MU.7530	10K. (C.T.)	6-7-8	10K.	1-4	1 (C.T.):1	600 Line Bridging
MU.7532	7.5/30*	1-3, 2-4	100K.	6-8	58:1/116:1	Low Z. Mic./Grid
MU.7534	50/200*	1-3, 2-4	100K.	6-8	22-4:1/44-8:1	Mic. or Line/Grid

Type MU.7525 may be used in "Hybrid" circuits, as shown, to establish 2 to 4 wire operation in telephony. Accurate balancing of the windings enable guaranteed rejection of better than — 55 dB from 50 c/s to 10 kc/s. Up to — 75 dB may be expected for normal rejection levels.

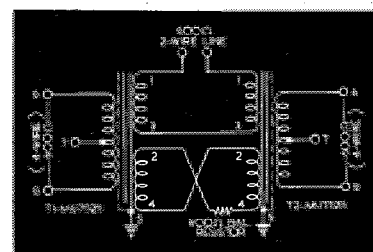

**Gardners**

WRITE FOR A.F. BROCHURE GT.4  
giving full details of these and other types of A.F. transformers

**GARDNERS TRANSFORMERS LIMITED**  
**Christchurch, Hampshire. Tel. Christchurch 1734\***

Telex 41276 A.B. Gardners Xch. \*When changed to Automatic approx. June 1968 — Christchurch 2284

THE

**Adamin**

DE-SOLDERING TOOL

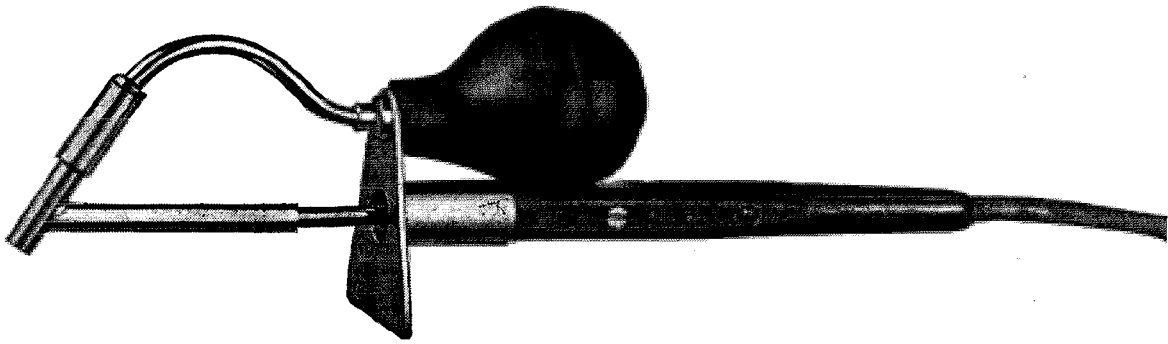

- Self-contained—does NOT require the use of air-lines or pumps
- Simple, light and inexpensive
- PERMABIT nozzle will not wear or become eroded by the solder
- Standard nozzle  $\frac{5}{16}$  in. bore. Alternative,  $\frac{3}{8}$  in. bore
- Mains or low voltages

*Please ask for colour catalogue A/5*

**LIGHT SOLDERING DEVELOPMENTS LTD**

28 Sydenham Road, Croydon, CR9 2LL

Telephone : 01-688 8589 & 4559

WW-047 FOR FURTHER DETAILS

Accurate and direct  
measurement of speed  
without coupling to moving  
parts

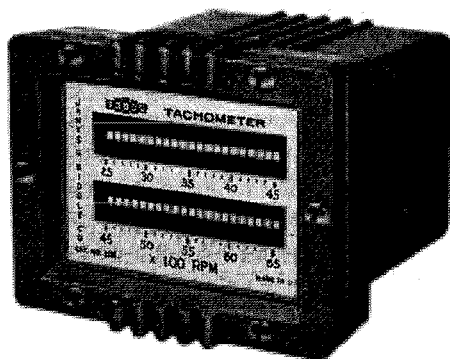

**FRAHM**

**Resonant Reed TACHOMETERS**

for hand use or permanent mounting.

Ranges and combinations of ranges from 900 to 100,000 r.p.m.

Descriptive literature on FRAHM Tachometers and Frequency Meters is freely available from the Sole U.K. distributors:

**ANDERS METER SERVICE**

ANDERS ELECTRONICS LTD. 48/56 BAYHAM PLACE, BAYHAM STREET LONDON NW1 TEL: 01-387 9092. *MINISTRY OF AVIATION APPROVED*

WW-048 FOR FURTHER DETAILS

Looking for  
one like this?



6mm tubular midget  
flange S6/8 cap  
over-all length  
14.5 mm.

It is one of the many Vitality Instrument and Indicator Lamps that are made in an unusually large number of types, ratings and sizes. It may be just what you need for an existing or new project. If not, another from the hundreds of types and ratings detailed in the Vitality Catalogue may well be.

*\*Many a product owes its success to the intelligent addition of an indicator light.*

**VITALITY BULBS**

VITALITY BULBS LTD MINIATURE AND SUB-MINIATURE LAMP SPECIALISTS  
BEETONS WAY, BURY ST. EDMUNDS, SUFFOLK. TEL. BURY 2071. S.T.D. 0284 2071

WW-049 FOR FURTHER DETAILS

# HUNTS

give designers the best of both worlds...

... all the advantages of a **metallised polyethelene terephthalate film** capacitor



... **humidity resistant housing of tough, clean epoxy resin** neatly styled to eliminate any moisture trap between terminations.

## New Hunts Type M314

gives high standards of reliability in a new range specifically designed for printed circuitry.

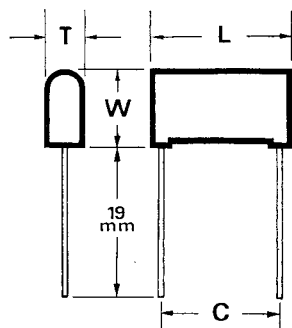
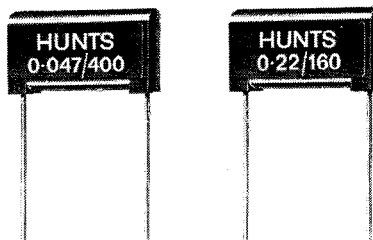

**Temperature** -55° to +100°C

**Humidity Classification**  
21 days (H5 DEF 5011)

### Hunts Type M314 Standard Capacitance Range

Capacitance Microfarads	160V. d.c. List Number	250V. d.c. List Number	400V. d.c. List Number
0.022			TMD 552
0.033			TMD 556
0.047			TMD 560
0.068		TMD 502	
0.1		TMD 506	
0.15	TMD 452		
0.22	TMD 456		
0.9		TMP 540*	
1.8		TMQ 541*	

\* These units are approved to Post Office Specification D2283

	Dimensions mm			
	L	W	T	C
TMD	18	10	5	15
TMP	31.75	22.23	7.94	27.5
TMQ	31.75	22.23	10.72	27.5

Please use the Reader Enquiry Service to obtain full technical information or contact us direct \*



**\*ERIE ELECTRONICS LTD.**  
SOUTH DENES  
GREAT YARMOUTH, NORFOLK  
Telephone: Great Yarmouth 4911

# FREE TO AMBITIOUS ENGINEERS

—THE LATEST EDITION OF ENGINEERING OPPORTUNITIES

## Have you sent for your copy?

ENGINEERING OPPORTUNITIES is a highly informative 132-page guide to the best paid engineering posts. It tells you how you can quickly prepare at home for a recognised engineering qualification and outlines a wonderful range of modern Home Study Courses in all branches of Engineering. This unique book also gives full details of the Practical Radio & Electronics Courses, administered by our Specialist Electronics Training Division—explains the benefits of our Appointments Dept. and shows you how to qualify for five years' promotion in one year.

## SATISFACTION OR REFUND OF FEE

Whatever your age or experience, you cannot afford to miss reading this famous book. If you are earning less than £30 a week, send for your copy of "ENGINEERING OPPORTUNITIES" today—FREE.

## WHICH IS YOUR PET SUBJECT?

Radio  
Television  
Electronics  
Electrical  
Mechanical  
Civil  
Production  
Automobile  
Aeronautical  
Plastics  
Building  
Draughtsmanship  
B.Sc.  
City & Guilds  
Gen. Cert. of  
Education  
etc., etc.

## PRACTICAL EQUIPMENT

Basic Practical and Theoretic Courses for beginners in Radio, T.V., Electronics, etc. A.M.I.E.R.E. City & Guilds Radio Amateur's Exam. R.T.E.B. Certificate P.M.G. Certificate Practical Radio Radio & Television Servicing Practical Electronics Electronics Engineering Automation

## INCLUDING TOOLS!

The specialist Electronics Division of B.I.E.T. NOW offers you a real laboratory training at home with practical equipment. Ask for details.



## POST COUPON NOW!

Please send me your FREE 132-page "ENGINEERING OPPORTUNITIES" (Write if you prefer not to cut page)

NAME .....

ADDRESS .....

SUBJECT OR EXAM. THAT INTERESTS ME .....

## BRITISH INSTITUTE OF ENGINEERING TECHNOLOGY

(Dept. 303B), Aldermaston Court, Aldermaston, Berkshire

THE B.I.E.T. IS THE LEADING INSTITUTE OF ITS KIND IN THE WORLD

WW—051 FOR FURTHER DETAILS

## Valradio TRANSVERTORS

(TRANSISTORISED D.C. CONVERTERS/INVERTORS)



TYPE: B12/150T PRICE: £24.3.0

OTHER TYPES AVAILABLE from 10w up to 1,000w FOR 12-24-50-110v DC inputs. PRICES: £4.10.0. up to £99.15.

THE "T" RANGE of units are economical, efficient and provide an output with a squarewave form. Suitable for operating:—VHF R/T—Radar-Echo Sounders—Ultra-violet Recorders—Fluorescent Lighting—Refrigeration in Boats and Caravans, etc. and are designed to provide the starting loads of F.H.P. motors and the high initial power in rectifier circuits.

SINEWAVE AND SQUAREWAVE, stable frequency ( $\pm \frac{1}{4}$  Hz) outputs are available in the "S" and "Q" ranges. WE SHALL BE HAPPY TO ASSIST WITH YOUR POWER CONVERSION PROBLEM. CALL, WRITE OR TEL: 01-890 4837

EXPORT ENQUIRIES INVITED—Demandes concernant l'exportation sollicitées—Se invitan consultas sobre exportación—Exportanfragen erbeten.

VALRADIO LIMITED, Dept. C10

BROWELLS LANE • FELTHAM • MIDDLESEX • ENGLAND  
Tel: 01-890 4242

WW—052 FOR FURTHER DETAILS

## WELWYN TOOLS

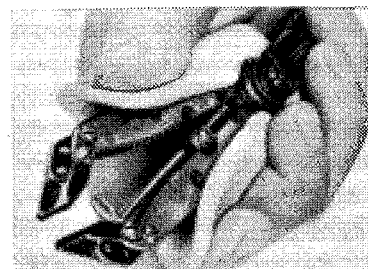
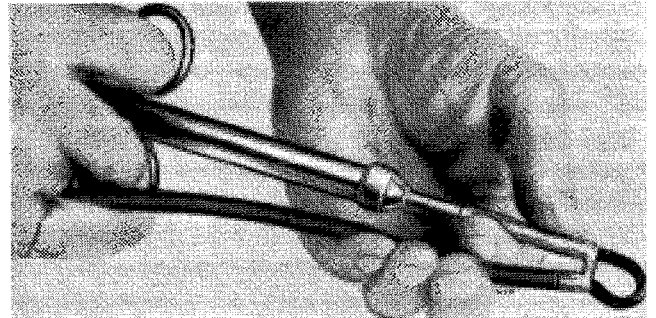

L67 - KIT - CN

For Inner Core Ejection and Heated Wirestripping Miniature Soldering and Electronic Instrument Work

USE W.T.C. Wire Ejectors, LUCO Electrically Heated Wire Strippers (see illustration), Finest Soldering Needles, Box Joint Miniature Cutters and Pliers including Tip Cutting Pliers, Printed Circuit Crimping and Cutting Pliers, Torque Wrenches and Piercing Punches. If you require quality tools ask for Catalogue WW/68.



STONEHILLS HOUSE WELWYN GARDEN CITY  
WELWYN GARDEN 25403

WW—053 FOR FURTHER DETAILS

# voltage problems?

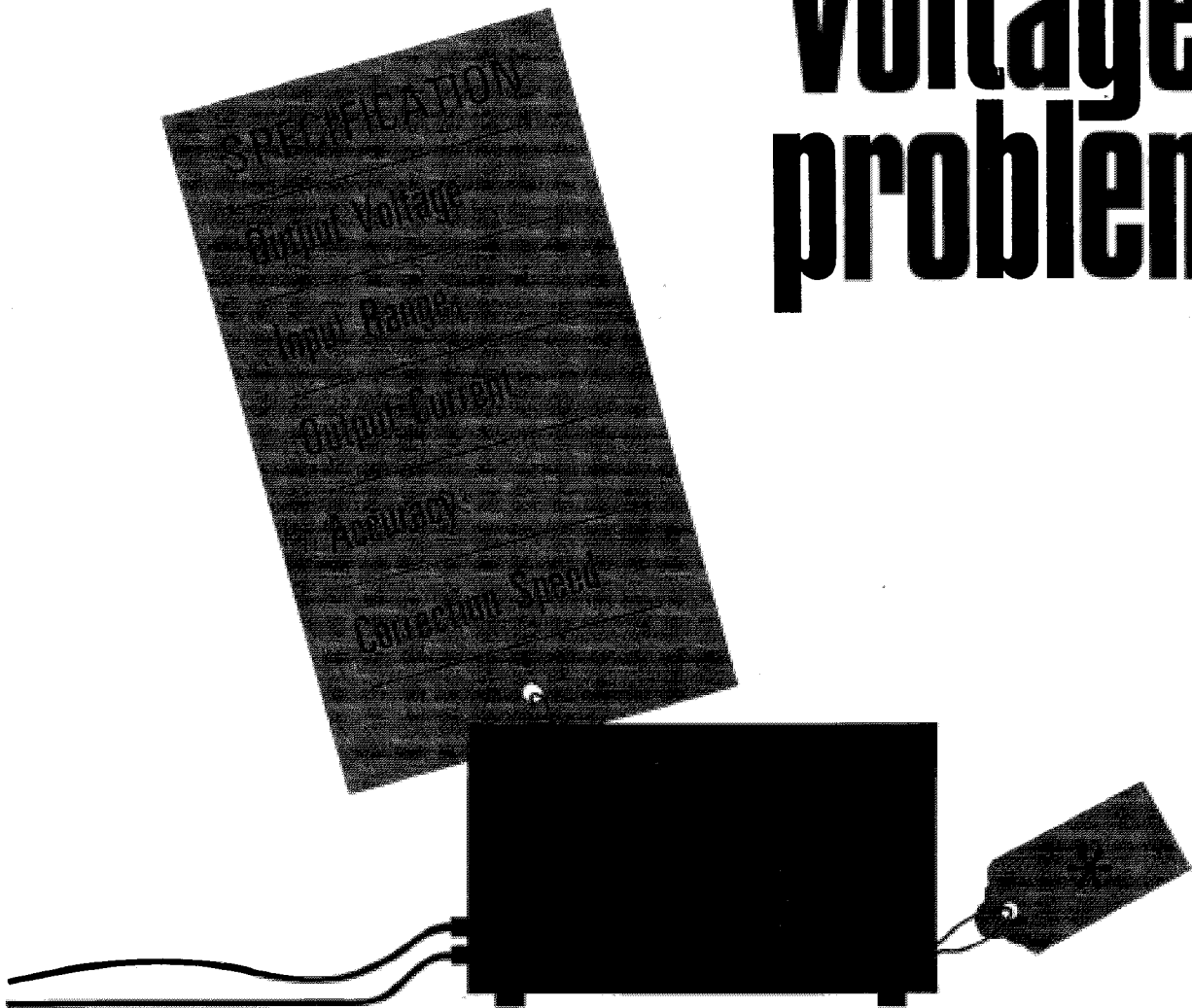

there is a standard  
**Claude Lyons voltage stabiliser**  
already built to  
*your specification*  
\* *and that includes price*

Claude Lyons make the most comprehensive range of voltage stabilisers available today. You will almost certainly find the stabiliser to suit your application in the Claude Lyons standard catalogue range. Distortionless servomechanical types from 1 to 120 kVA (and 360 kVA 3-phase). Solid-state types from 400 VA to 10 kVA. Simple tap-changing types from 600 VA to 2.4 kVA. All very high quality. All very reasonably priced. Full facts and figures from Publicity Department, Hoddesdon.

Claude Lyons Ltd ■ Valley Works, Hoddesdon, Herts Hoddesdon 67161 Telex 22724 ■ 76 Old Hall Street, Liverpool 3. MARitime 1761 Telex 62181

**CLAUDE LYONS**  
LEADERS IN VOLTAGE CONTROL



# Bullers CERAMICS

for the **ELECTRONIC INDUSTRY**  
(and Electrical Appliance Manufacture)

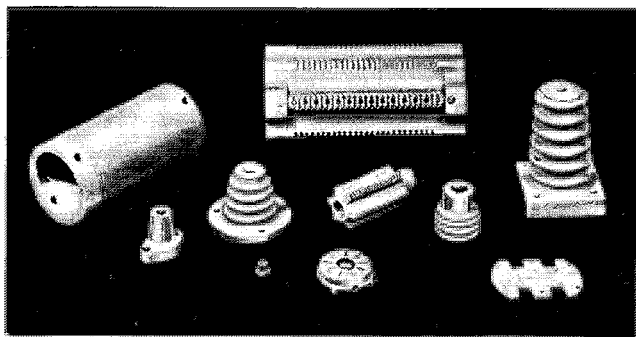

Frequelex—for high-frequency insulation.

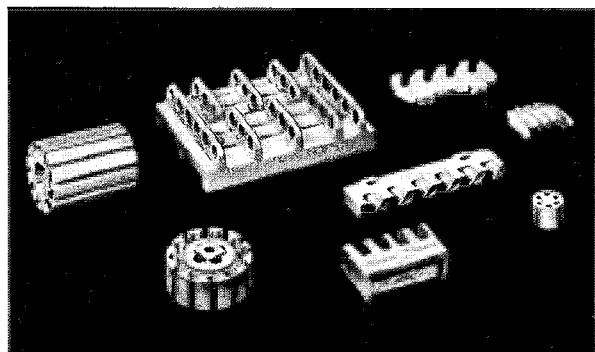

Refractories for high-temperature insulation.

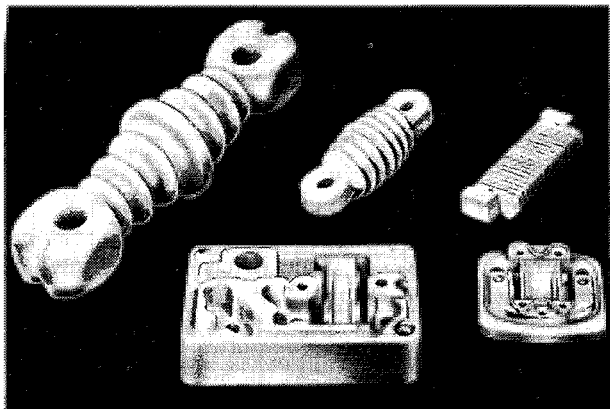

Bullers porcelain for general insulation purposes.

Meticulous care in manufacture, high quality material, with particular attention applied to *dimensional precision and accuracy*, explain the efficiency and ease of assembly when using Bullers die pressed products.

Write today for detailed particulars.

## BULLERS LIMITED

Milton, Stoke-on-Trent, Staffs.

Phone: Stoke-on-Trent 54321 (5 lines)

Telegrams & Cables: Bullers, Stoke-on-Trent

London Office: 6 Laurence Pountney Hill, E.C.4

Phone: MANSion House 9971

WW—055 FOR FURTHER DETAILS

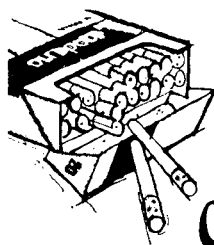

# We put 23,340 cigarettes



## in our Budget combination storage unit!

Think what you could  
put in it!

Storage. Lots of it, for a thousand things you stock: replacement parts; light bulbs; cameras; anything up to 7" x 8" x 10½". Safety drawer-stops as 'standard'. Smooth guide runners thro'out. All in a compact 3 ft-6 in high, 2 ft-11 in wide, 1 ft deep area. Ready assembled, in stove enamelled green. With 18 handy, 6 large, 8 king-sized drawers. At £15.19s. worth every penny! See the rest of the N. C. Brown range!

**£15.19s**  
BRAND NEW  
Spareage Free  
ON BUSINESS

**N.C. BROWN LTD.**  
pacesetters in storage equipment

Send your FREE BROCHURE  or Send  (how many) Budget Storage Units at £15.19s. in green

NAME .....  
ADDRESS .....

Dept. WW Eagle Steelworks, Heywood, Lancs. Tel: 69018  
London: 25-27 Newton St., W.C.2. Tel: 01-405 7931

WW—056 FOR FURTHER DETAILS

# TELEPRINTERS · PERFORATORS REPERFORATORS · TAPEREADERS EDITING & REPRODUCING SETS

Codes: Int. No. 2 Mercury/Pegasus, Elliot 803, Binary and special purpose Codes.



## 2-5-6-7-8- TRACK AND MULTIWIRE EQUIPMENT



TELEGRAPH AUTOMATION AND COMPUTER PERIPHERAL ACCESSORIES

Picture Telegraph, Desk-Fax, Morse Equipment; Pen Recorders; Switchboards; Converters and Stabilised Rectifiers; Tape Holders, Pullers and Fast winders; Governed, Synchronous and Phonic Motors; Teleprinter Tables and Cabinets; Silence Covers; Distortion and Relay Testers; Send/Receive Low and High Pass filters; Teleprinter, Morse, Teledeltos Paper, Tape and Ribbons; Polarised and specialised relays and Bases; Terminals V.F. and F.M. Equipment; Telephone Carriers and Repeaters; Multiplex Transmitters; Diversity, Frequency Shift, Keying Equipment; Line, Mains Transformers and Suppressors; Racks and Consoles; Plugs, Sockets, Key, Push, Miniature and other Switches; Cords, Wires, Cables and Switchboard Accessories; Teleprinter Tools; Stroboscopes and Electronic Forks; Cold Cathode Matrices; Test Equipment; Oscilloscopes; Miscellaneous Accessories and Spares.



## W. BATEY & COMPANY

Gaiety Works, Akeman Street, Tring, Herts.

Tel.: Tring 3476 (3 lines)

Cables: RAHNO TRING

STD: 044 282

TELEX 82362

WW—057 FOR FURTHER DETAILS





## 10 GNS WRAPS UP YOUR SPEAKER PROBLEMS

with Wharfedale's Unit 3 speaker kit

Wharfedale have designed a new genuine high fidelity system that *you can build yourself*. With the Unit 3 Kit you get : an 8" speaker (with a magnetic field of 12,000 oersteds) which covers the bass and middle ranges ; the new Wharfedale tweeter with acoustiprene dome ; an electrical cross-over unit ; acoustic wadding, wiring, etc., and a complete assembly

instruction leaflet, in fact, everything you need to build a compact speaker system.

You can build the Unit 3 Kit into one of two cabinet sizes. In the smaller cabinet the system will give a faithful and rich reproduction of all musical sounds from 65 - 17,000 Hz. The larger cabinet increases the range from 40 - 17,000 Hz.



RANK WHARFEDALE LTD., IDLE, BRADFORD, YORKS.

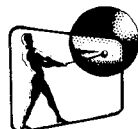

WW—058 FOR FURTHER DETAILS

## SUPERIOR...WORLD LEADER in the manufacture of ELECTRON GUNS exclusively!

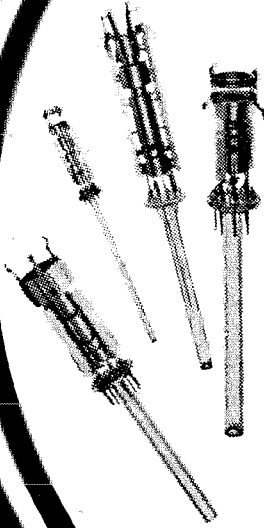

Now, from new, modern, expanded facilities... men, minds and machines coupled with professional experience, organization and resources produce SUPERIOR ELECTRON GUNS... unequalled throughout the world!

Precision guaranteed, quality built, with optimum functional reliability, SUPERIOR ELECTRON GUNS give you the widest range of electrostatic and magnetic focus types available... for color and black and white application in commercial, industrial, special purpose, military and European tube types.

Write today for further information and catalog of facilities and types.

### SUPERIOR ELECTRONICS Company

(Division of AIKEN INDUSTRIES, Inc.)

CLIFTON, N. J., U. S. A. / CABLE ADDRESS: "SECO" CLIFTON, N. J., U. S. A.

LONDON STOCKISTS: ELECTRODE WELDING CO., LTD.

Jubilee Works Cobbold Road, Willesden, London N.W. 10, England

Telephones: Willesden 5050 / Willesden 6655-6

Telegrams: Elecwhyb Norphone London Cables: Elecwhyb, London, N.W. 10



© 1967 Superior Electronics Co.

WW-059 FOR FURTHER DETAILS

## DIFFERENTIAL DC AMPLIFIERS for use with dc energised transducers

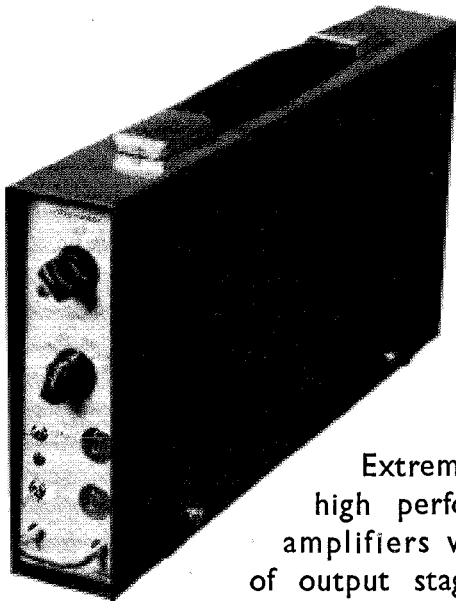

**03  
150  
160**  
series  
in  
card  
modular  
cased  
form

Extremely versatile high performance dc amplifiers with choice of output stage to drive a wide range of indicating, recording and control devices Also Bridge Supplies and Bridge Balance Units.

**FYLDE** Electronic Laboratories Ltd.,  
Oakham Court, PRESTON PR13XP  
Telephone Preston 57560

WW-060 FOR FURTHER DETAILS

## EDDYSTONE COMMUNICATION RECEIVERS

For the Professional or Amateur user who likes the Best.

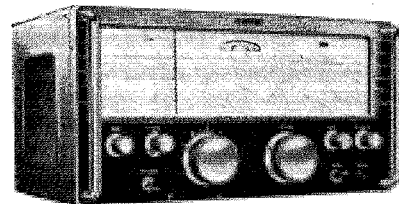

840C  
£66

EC10	£53	840C	£70
EB36	£54-5-7	940	£143
EB36	£60-6-3	EA12	£195
		830/7	£275

H.P. Terms gladly arranged. Quick Delivery.  
Carriage Paid.



Telephone: AINTREE 1445

SEND 6d STAMP FOR LITERATURE TO

The Eddystone  
Specialists

**SERVICES LTD.**  
51 COUNTY ROAD,  
LIVERPOOL, 4  
ESTAB. 1935

WW-061 FOR FURTHER DETAILS

# Just what *is* this ABR, that makes such a vital difference to the 'DITTON 15' ?

To achieve really impressive bass reproduction a speaker *must* move a large volume of air at the lower frequencies. In the usual "infinite baffle" compact system this is achieved by large excursions of the diaphragm—with good results if the designers and engineers have done their homework (listen to the 'Ditton 10'). But with the 'Ditton 15' Celestion have come up with something even better. They have given a dramatic further improvement in the bass response by a novel design idea called the ABR (Auxiliary Bass Radiator).

The ABR is a rigid diaphragm with a linear suspension capable of large excursions, pressure driven by the rear radiation from the 8" bass unit. The acoustic mass of the ABR and the response of the 8" bass unit are so matched that from 80Hz down to 30 the ABR moves in phase with the bass loudspeaker cone. It progressively radiates more of the bass frequencies as the bass loudspeaker's own power output falls away. This sharing of the load results in a clarity of sound in the bass frequencies and permits a full 15 Watt power down to 30Hz. Above 80Hz the ABR is stationary leaving the enclosure to act as a pure infinite baffle.

**And what about the high notes? They are in the care of the famous HF1300 Mk. 2. Enough said!**

But don't take our technical word for it. Hearing is believing! Ask your local Hi Fi dealer to demonstrate the 'Ditton 15' and compare it for yourself. Or send in the coupon now, and we will let you have full details and technical specification—not only of the 'Ditton 15', but also of the famous 'Ditton 10', the inexpensive but most sophisticated mini-speaker on the market.

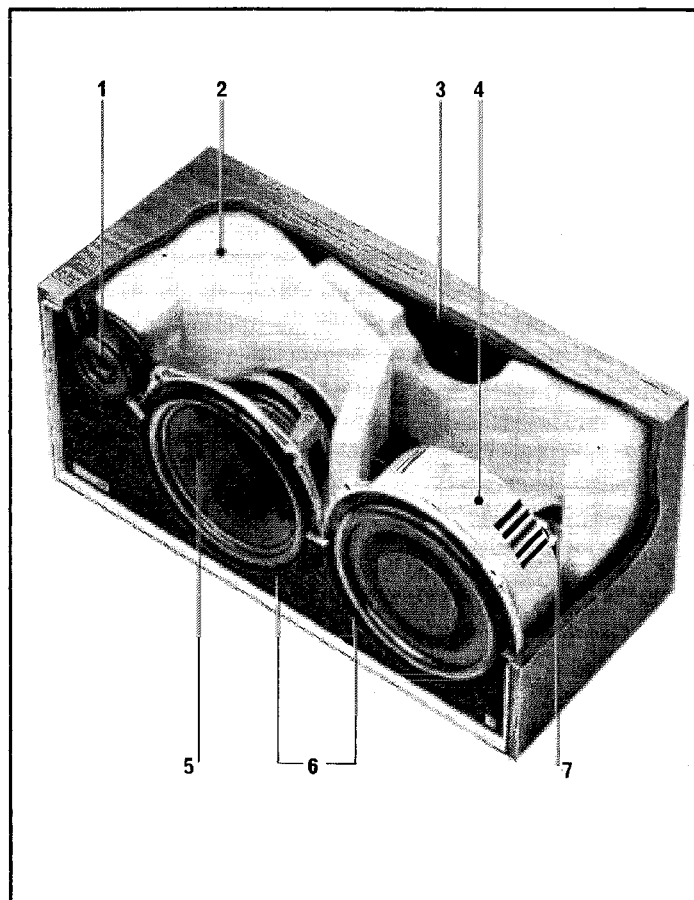

1. Studio quality high frequency unit HF1300
2. Anechoic cellular foam wedge and lining eliminates standing waves.
3. High hysteresis panel loading material to eliminate structural resonances.
4. Auxiliary Bass Radiator (ABR)—plastic foam diaphragm of high rigidity and low mass having a free air resonance of only 8Hz; double roll suspension allowing excursions up to  $\frac{3}{4}$ " with virtual absence of distortion.
5. 8" bass unit, with free air resonance of 25Hz, and massive Ferroba II magnet structure for optimum magnetic damping and cone treated with viscous damping layer to suppress resonances.
6. Units mounted flush to eliminate diffraction effects and tunnel resonances; covered by acoustically transparent grille cloth for maximum presence.
7. Full L-C Crossover network.

**Celestion**

Studio  
Series

loudspeakers for  
the perfectionist

Rola Celestion Ltd. Ferry Works, Thames Ditton, Surrey.

Please send details of the Ditton '10' and '15'

NAME \_\_\_\_\_

ADDRESS \_\_\_\_\_

WWW.

**Rola Celestion Ltd Ferry Works,**

Thames Ditton, Surrey

Tel 01-398 3402

GD 996

WW—062 FOR FURTHER DETAILS

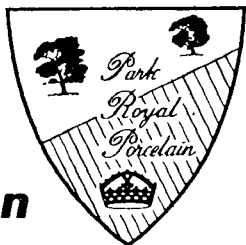

**Porcelain**

**Steatite**

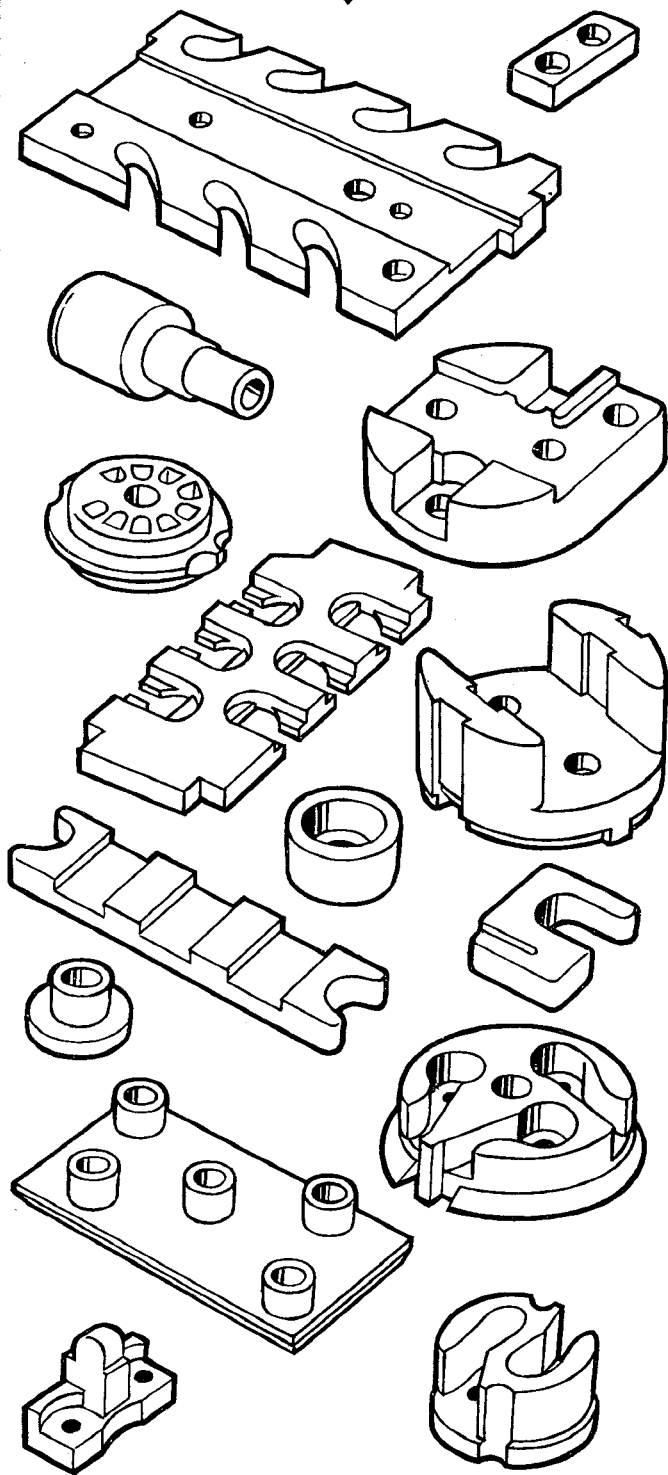

**PARK ROYAL PORCELAIN CO LTD**  
**INCORPORATING V.G. PORCELAIN CO LTD**

GORST ROAD  
 PARK ROYAL  
 LONDON, N.W.10

Telephones:  
 ELGAR 1411/7  
 Telex:  
 London 25589

WW—063 FOR FURTHER DETAILS

# TECHNICAL TRAINING by **ICS** IN RADIO, TELEVISION AND ELECTRONIC ENGINEERING

First-class opportunities in Radio and Electronics await the ICS-trained man. Let ICS train YOU for a well-paid post in this expanding field.

ICS courses offer the keen, ambitious man the opportunity to acquire, quickly and easily, the specialized training so essential to success. Diploma courses in Radio/TV Engineering and Servicing, Electronics, Computers etc. Expert coaching for:

- \* INSTITUTION OF ELECTRONIC AND RADIO ENGINEERS.
- \* C. & G. TELECOMMUNICATION TECHNICIANS CERTS.
- \* C. & G. ELECTRONIC SERVICING.
- \* R.T.E.B. RADIO AND TV SERVICING CERTIFICATE.
- \* RADIO AMATEURS EXAMINATION.
- \* P.M.G. CERTIFICATES IN RADIOTELEGRAPHY.

Examination Students Coached until Successful.

**NEW SELF-BUILD RADIO COURSES**

Build your own 5-valve receiver, transistor portable, signal generator and multi-test meter—all under expert tuition.

POST THIS COUPON TODAY and find out how ICS can help YOU in your career. Full details of ICS courses in Radio, Television and Electronics will be sent to you by return mail.

MEMBER OF THE ASSOCIATION OF BRITISH CORRESPONDENCE COLLEGES.

<b>INTERNATIONAL          CORRESPONDENCE          SCHOOLS</b>	International Correspondence Schools (Dept. 222), Intertext House, Parkgate Road, London, S.W.11.
	NAME .....
	ADDRESS ..... Block Capitals Please
	..... 3.71

**A WHOLE WORLD  
 OF KNOWLEDGE  
 AWAITS YOU!**

WW—064 FOR FURTHER DETAILS

## METER PROBLEMS?

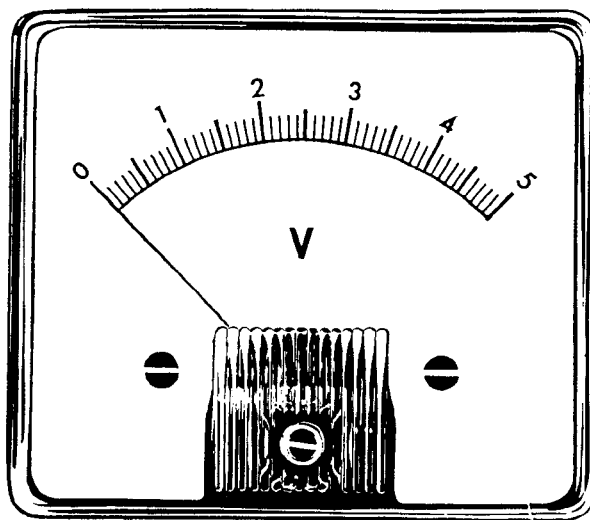

A very wide range of modern design instruments is available for 10/14 days delivery.

Full Information from:

**HARRIS ELECTRONICS (London)**

138 GRAYS INN ROAD, W.C.1

Phone: 01/837/7937

WW—065 FOR FURTHER DETAILS

# **Vortexion**

*quality equipment*

## TYPE C.B.L./7T TAPE RECORDER

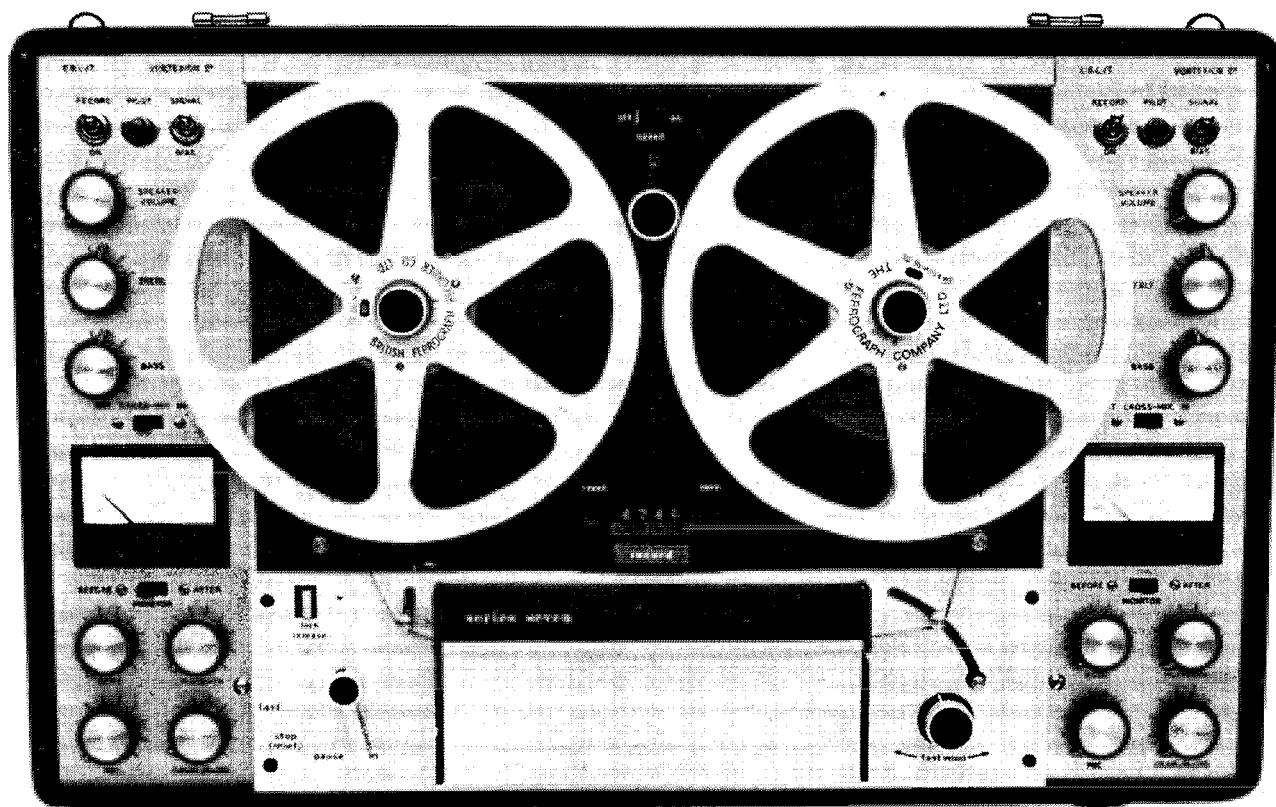

Here is a versatile stereophonic recorder which has no equal in its price group.

The C.B.L./7T solid state version uses 8 low noise Field Effects Transistors on its twin channel Mic. P.U. and Playback inputs to give low intermodulation distortion, and the 10 watts sine wave 15 watt speech and music amplifiers each have less than 0.05% harmonic distortion and less than 0.1% intermodulation distortion at 10 watts output.

“Before and After” monitoring on phones and by internal or external speakers is catered for, and separate power amplifier volume controls allow the speakers to be independently controlled from the headphones. 30/50Ω balanced line Microphone and P.U. inputs can be mixed with the other channel via a crossmix and an echo control.

All the facilities of the valve model C.B.L. are provided, plus a few extras... The series 7 deck has variable speed wind in either direction, solenoid operation, provision for an external switch for remote run or voice operated accessory, and still lower wow and flutter figures.

Mono and full track versions of this will also be available.

**VORTEXION LIMITED, 257-263 The Broadway, Wimbledon, S.W.19**

Telephone: 01-542 2814 & 6242/3/4

Telegrams: “Vortexion London S.W.19”

WW—066 FOR FURTHER DETAILS

# Trend cards make IC mounting easier

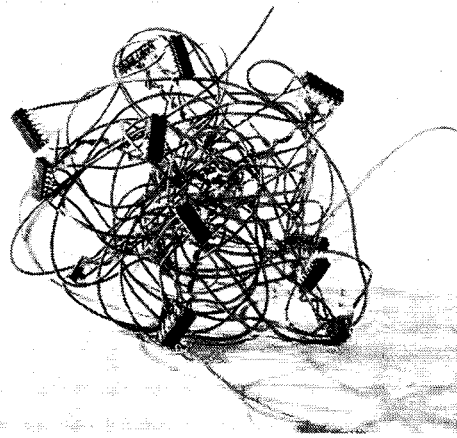

Two standard sizes of IC mounting cards are now in stock, 6" x 3 1/4" to take 20 IC's and 12" x 4" to take 40 IC's. These are suitable for APT 'Lektrokit' racking. Other sizes are available to order for Imhof and other makes of chassis.

Each IC lead is attached to a terminal pin and connections can be either soldered or wire wrapped. Interconnections can be made using PTFE-covered wire. A 23-way varicon or edge connector is incorporated.



## TREND ELECTRONICS LTD

St. John's Works, Tylers Green,  
High Wycombe, Bucks.  
Tel: Tylers Green 322/323

Electronic System Engineers · Manufacturers of: Core Stores · IC Cards · Numerical Display Cards  
Data Transmission Equipment

WW—067 FOR FURTHER DETAILS

### VARIABLE—HIGH CURRENT SMOOTHED POWER SUPPLIES WITH ACCUMULATOR PERFORMANCE DIRECT FROM A.C. MAINS

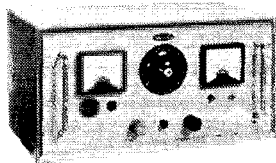

**TYPES**  
250VRU/30/20  
250VRU/60/10  
250VRU/120/5  
250VRU/240/2.5

**PRICE:**  
£131.50

**TYPE 250VRU/30/20** provides outputs of 0-30 v. D.C. continuously variable, up to 20A. Overload capacity 200% for short periods Ripple Content, impedance and regulation equivalent to accumulator performance. Output protected.

**INCORPORATES HEAVY DUTY SILICON RECTIFIERS.** Complete with volt and amp meters, free standing, but suitable for 19in. racking.

**USED BY MINISTRY OF TECHNOLOGY:** Aircraft operators, for servicing 28 v. aircraft instruments, radio; within B.C.A.R.'s.

**FIXED OUTPUTS ALSO AVAILABLE.** Smoothed 12 or 24 v. up to 24 amps Applications. operating and servicing transistorised equipments, e.g. 12-24 v. mobile r/telephone; production testing D.C. motors; heaters, wipers ignition systems, etc., etc. Direct from A.C. without accumulators.

Avoid the extra expense of super regulation you may never need.

**PRICES:** from £31/4/- up to £88/4/-.

We shall be happy to assist with your power conversion problems. Call, write, or Tel.: 01-890 4837.

EXPORT ENQUIRIES INVITED\*\*

DEPT. PUI3  
BROWELLS LANE,  
FELTHAM,  
MIDDLESEX,  
ENGLAND.  
TEL: 01-890 4242



LIMITED

\*\*DEMANDES CONCERNANT L'EXPORTATION SOLICITÉS. SE INVITAN CONSULTAS SOBRE EXPORTACIÓN. EXPORTANFRAGEN ERBETEN.

WW—068 FOR FURTHER DETAILS

## TRANSIPACK<sup>®</sup> EMERGENCY

- STATIC  
NO-BREAK  
POWER  
SUPPLIES
- FREQUENCY  
CHANGERS
- INVERTERS

**BEST**  
PERFORMANCE

DESIGN

DELIVERY

SIZES  
up to 200 KVA

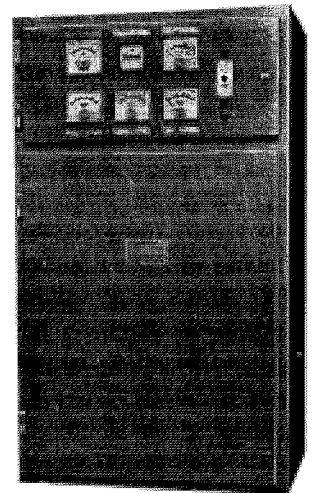

**INDUSTRIAL  
INSTRUMENTS  
LIMITED** STANLEY RD., BROMLEY, KENT

Tel: 01-460 9212

Grams: Transipack Bromley

WW—069 FOR FURTHER DETAILS

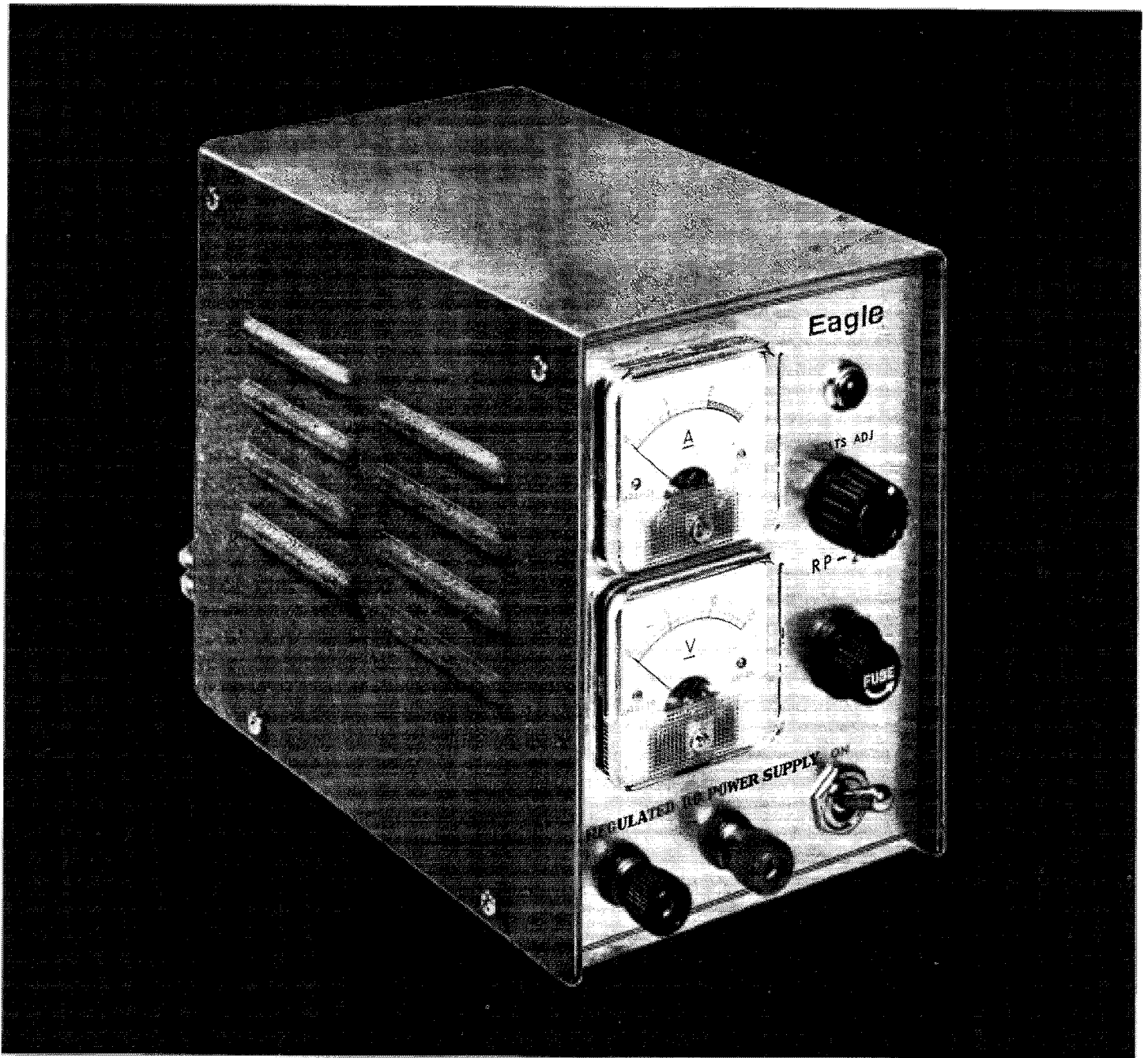

## EAGLE ANNOUNCE AN IMPORTANT NEW POWER SUPPLY

**MODEL RP.215** all transistor regulated 2 Amp DC power supply. In relation to cost the RP.215 offers unequalled performance, reliability, advanced design and engineering techniques. A truly miniature laboratory or bench variable DC voltage power supply for use in electronic areas such as component evaluation, circuit development, educational experiment, test facility or production line. Output Voltage: 0-15 volts DC continuous variable. Output current 0-2 Amps DC. Line Regulation: Better than 0.05%. Ripple: 3mV peak-to-peak full load. Input voltage: 220/240 volts AC. Protection Circuit: Constant current shifting, automatic return. Operating Temperature: 0-50°C. Meters: 2 meters for voltage and current, simultaneous monitoring, guaranteed 12 months. Size:  $7\frac{1}{2}'' \times 5\frac{3}{8}'' \times 3\frac{7}{8}''$



Distributed by  
B. Adler & Sons (Radio) Ltd.  
Instruments Division  
Coptic Street, London, W.C.1

**EAGLE VERSATILITY AND RELIABILITY FOR ONLY £19. 10. 0.**

WW—070 FOR FURTHER DETAILS

# ELCOM sound equipments

ranging from 6  
channel modular  
mixers to meet  
the budget  
conscious  
markets

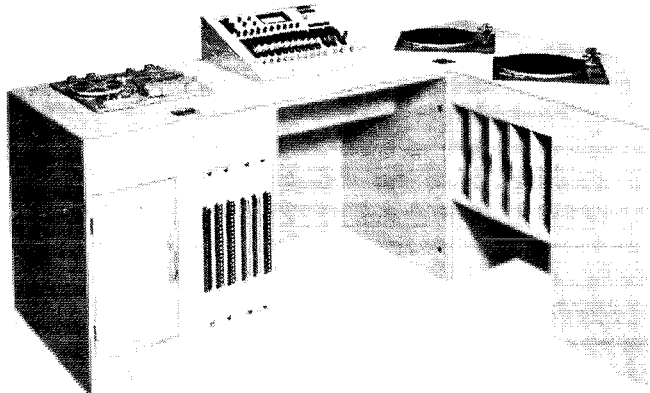
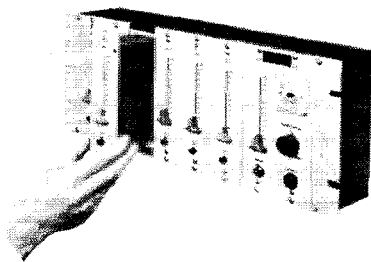

to multi channel  
consoles of  
broadcast quality

Elcom manufacture a full range of modules including input modules, output units, level amplifiers, equalisation units and p.p.m. units. Full details available on request.

**ELCOM**  
(NORTHAMPTON)  
LIMITED

A MEMBER OF THE  GROUP

ELCOM (NORTHAMPTON) LTD  
WEEDON ROAD INDUSTRIAL  
ESTATE  
NORTHAMPTON Tel: 51873

WW—071 FOR FURTHER DETAILS

## ALL TIED UP WITH MICROPHONE LEADS?

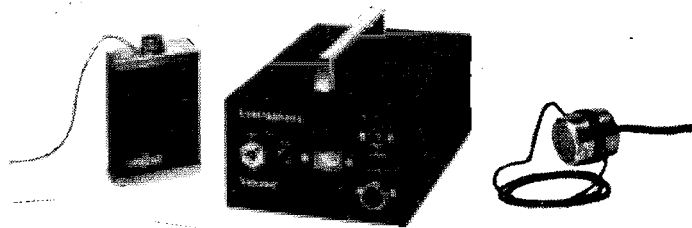

Do you find that your leads are always getting in the way? Then use the LUSTRAPHONE "Radiomic" System and then you'll have no lead at all. Capable of providing a microphone link over distances of  $\frac{1}{4}$  mile, the "Radiomic" in no way limits the performance of even the finest microphones. The perfect mates for the "Radiomic" are the LUSTRAPHONE 10 watt and 50 watt Amplifiers. By employing brilliantly simple and advanced circuitry, these amplifiers combine performance and reliability to a greater degree than ever before. Brief Specification:— Frequency Response 20Hz -20KHz  $\pm 1$  dB. Total Distortion 0.5% at full power. Send for free illustrated leaflets giving full details of "Radiomic" Systems and 10 watt and 50 watt Amplifiers.



**lustraphone**

THE FOREMOST NAME IN MICROPHONES

Lustraphone Ltd., Regents Park Road, London N.W.1

01-722 8844

WW—072 FOR FURTHER DETAILS

### HOWELLS RADIO LTD.

MINISTRY OF AVIATION INSPECTION APPROVED

#### TRANSFORMERS

STANDARD RANGE OR DESIGNED TO YOUR SPECIFICATION.

0-50KVA, "C" CORE, PULSE, 3 PHASE, 6 PHASE, TOROIDS, ETC.

Transformers for 20W Transistor Amplifier (W.W., Nov. 1966).

Driver 22/6 Carr. 2/-

Mains 29/6 Carr. 4/6

L.P. Filter, Chassis Mounting 11/6. Carr. 1/-.

L.P. Filter, Printed Circuit Mounting 14/6. Carr. 1/-.

#### \*MAINS TRANSFORMERS

350-0-350 v. 60 mA., 6.3 v. 2 A. £1/15/-, Carr. 4/6.

500 v. 300 mA. 6.3 v. 4 A., 6.3 v. 1 A. £3/12/6. Carr. 5/6.

500-0-500 v. 0.25 A., 6.3 v. 4 Act., 6.3 v. 3 Act., 5 v. 3 A. £4/10/6. Carr. 6/6.

525-0-525 v. 0.5 A., 6.3 v., 6 Act., 6.3 v., 6 Act., 5 v. 6 A. £5/5/-, Carr. 6/6.

#### \*LOW VOLTAGE

30-0-30 v. 4 A. £2/5/6. Carr. 5/6.

15 v. 2 A. £1/12/6. Carr. 3/-.

15 v. 6 A. £2/1/-, Carr. 4/6.

15 v. 10 A. £2/15/-, Carr. 5/6.

#### TRANSISTOR POWER SUPPLY TRANSFORMER

0-2-4-6-8-10-20-30-40-50 v. 2 A. £4/10/-, Carr. 6/-.

\*PRIMARIES 10-0-200-220-240 v.

CHASSIS, CABINETS & PRECISION METALWORK

ELECTRONICS — DEVELOPMENT & ASSEMBLY

CASH WITH ORDERS PLEASE

Carlton Street, Manchester 14, Lancashire

TEL. (STD 061) 226-3411

WW—073 FOR FURTHER DETAILS



# IOR the current slicers

International Rectifier  
semiconductors lead the world  
when it comes to slicing current  
waveforms—into just the right  
shape to solve your own  
particular problems.

Whatever the application—rely on **IOR**

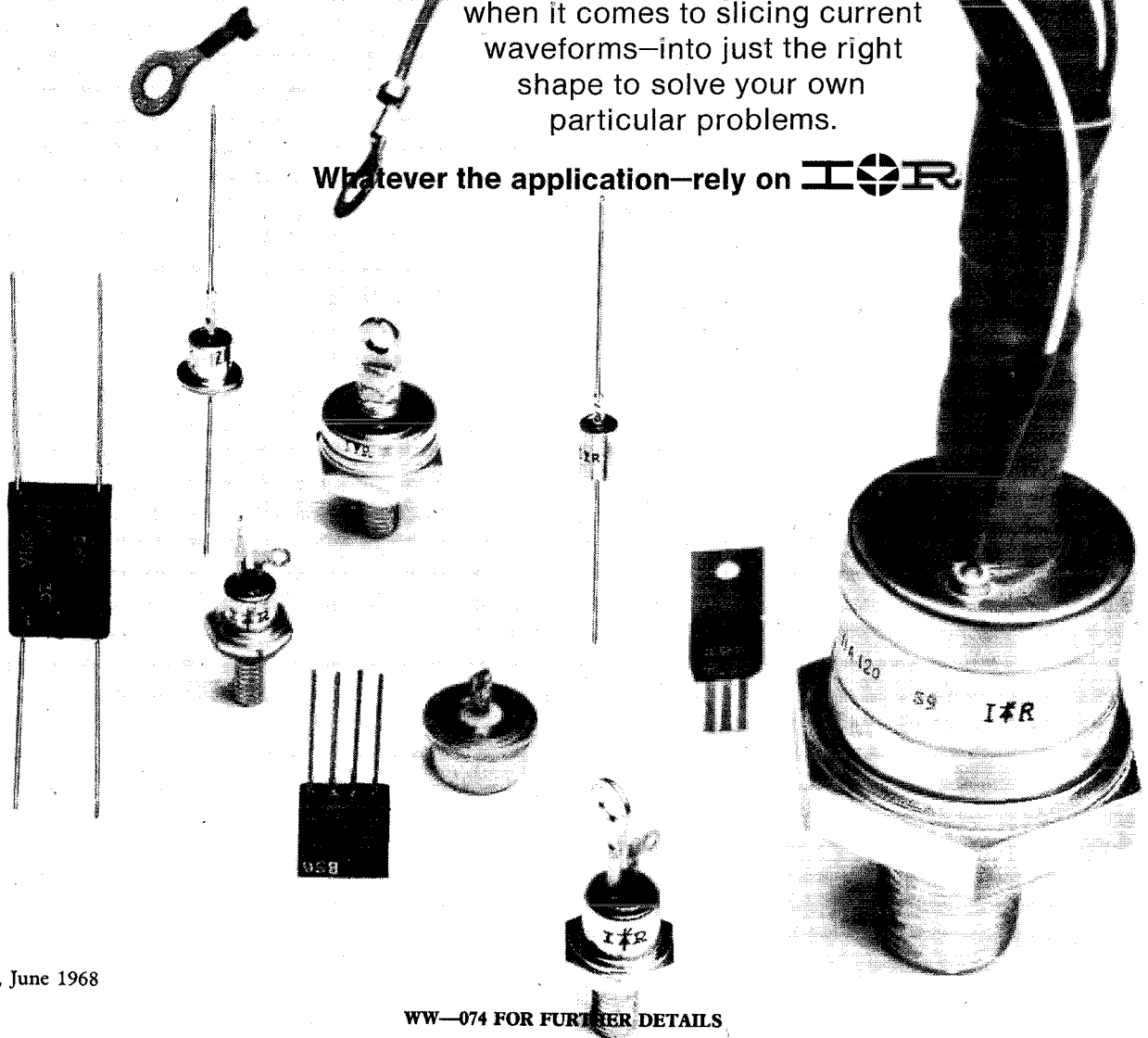

# TOA PUBLIC ADDRESS EQUIPMENT IS HERE

THERE'S MORE TO



THAN MEETS THE EYE

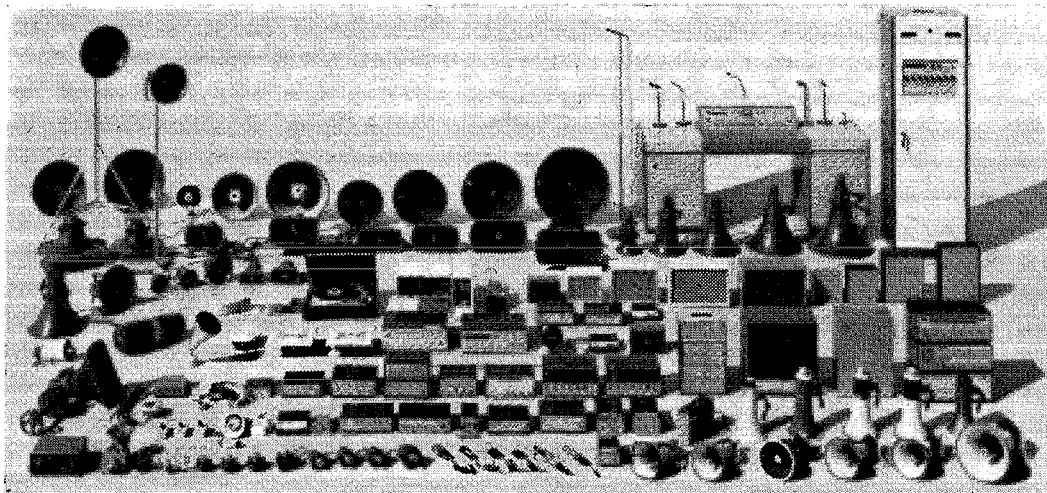

Tough compact construction utilising the latest advancements in printed circuitry mean that TOA stationary or mobile P.A. system gives clear powerful

amplification plus maximum adaptability and convenience with minimal maintenance. TOA specialists in SOUND.

For full details:

**AUDIO & DESIGNS (SALES) LTD.**  
40 QUEEN STREET, MAIDENHEAD, BERKS  
Tel. Nos. 25630 or 25204.

## TRANSISTOR & VALVE AMPLIFIERS, MIXERS, MEGAPHONES, SPEAKERS, HORNS

WW-075 FOR FURTHER DETAILS

# checking dynamic range?

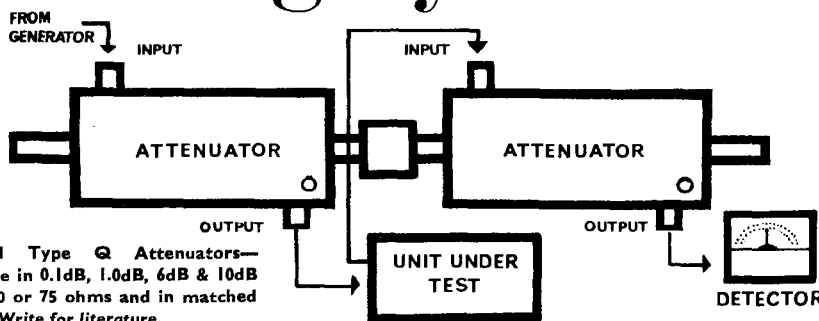

Hatfield Type Q Attenuators—available in 0.1dB, 1.0dB, 6dB & 10dB steps, 50 or 75 ohms and in matched pairs. Write for literature.

Yes? Then you'll be interested in this application for Hatfield Type Q Attenuators. Since this type is available with spindle at both ends, two units can be mechanically coupled so that increasing attenuation by one unit is accompanied by decreasing attenuation by the other. Thus, overall attenuation remains constant, but the level at the instrument under test can be varied over the full range of the attenuators.

Typical applications include determination of input/output linearity characteristics of an amplifier (figure of merit) or of transfer characteristics of modulators and passive couplers.

Hatfield Instruments Ltd., Dept. WW,  
Burrington Way, Plymouth, Devon  
Telephone: Plymouth (0752) 72773/4 Telegrams: Sigjen, Plymouth

WW-076 FOR FURTHER DETAILS

## HATFIELD BALUN



**POWER SUPPLY 22 £14 0 0**  
TRANSISTORISED

# NOMBREX

NEW STYLE IMPROVED INSTRUMENTS  
OTHER MODELS AVAILABLE—

- R.F. GENERATOR 31 ..... £12 10 0
- C.R. BRIDGE 32..... £10 10 0
- INDUCT. BRIDGE 33..... £20 0 0

SEE PREVIOUS ISSUES FOR DETAILS  
ALL IN FULL PRODUCTION  
POST & PKG. 6/6 EACH EXTRA

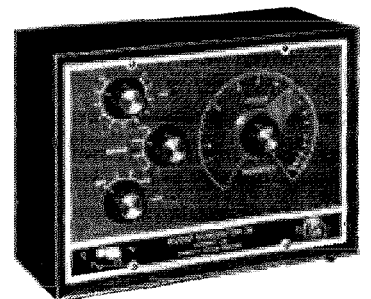

**A.F. GENERATOR 30 £19 10 0**  
TRANSISTORISED

6d. STAMP FOR ALL LEAFLETS

**NOMBREX LIMITED • EXMOUTH • DEVON**

TRADE AND EXPORT ENQUIRIES  
INVITED

WW-077 FOR FURTHER DETAILS

# If i'd only tried **Pinnacle** first...

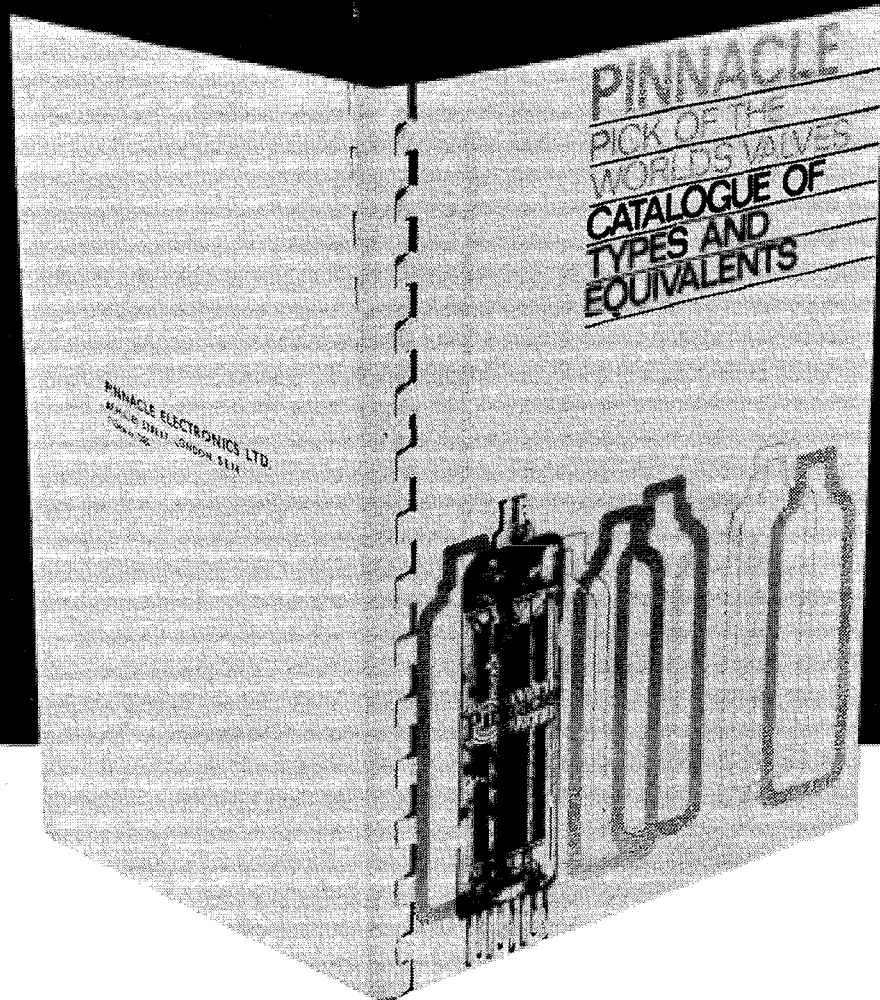

## **Pinnacle**

The widest ranging and most comprehensive valve catalogue available from any independent supplier.

**PINNACLE ELECTRONICS LTD** ACHILLES STREET · NEW CROSS · LONDON S.E.14

Telephone: All Departments—01-692 7285 Direct orders—01-692 7714

WW-078 FOR FURTHER DETAILS

# VOLTMETERS SIGNAL GENERATORS POWER SUPPLIES

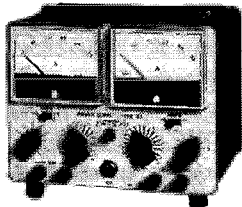

S.I. Twin Power Supply.

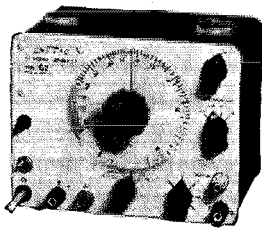

G.2. L.F. Signal Generator.

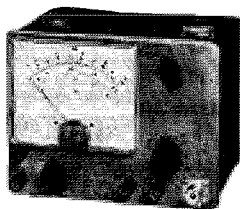

M.I. Voltmeter.

Linstead instruments are designed for accurate yet continuous hard work. Here are shown just three in the range which are receiving such glowing comments as "... does everything that instruments costing several times its price can do" (letter available for inspection). These are products which can be relied upon time and time again. Below we give a brief specification of three.

### S.I. Twin stabilised Power Supply

Controlled by silicon transistors. Two supplies each. 0 to 20V, 0 to 0.5A. Full overload and short circuit protection. £45 nett U.K.

### G.2. L.F. Signal Generator

10 Hz to 100 kHz  $\pm 2\%$   $\pm 1$  c/s. Sine wave. 0.6V low distortion. Square wave 0-9V. No droop H.F. rise time 1  $\mu$ s. 1 Watt into 3 ohms. £24 nett U.K.

### M.I. Electronic Voltmeter

15 A.C. ranges. 1 mV to 500V. 10 Hz to 100 kHz. 3 D.C. ranges. 0-400V. Input impedance. 10 Mohms on A.C. and D.C. £26 nett U.K.

**LINSTEAD ELECTRONICS**  
35 NEWINGTON GREEN, LONDON, N.16 Tel: CL1 4825

WW—079 FOR FURTHER DETAILS

## VARI-STAT THERMOSTATIC SOLDERING IRON



MINIATURE IRON (Half Size)

### HIGH PRODUCTION MINIATURE MODEL D. 50 WATT

Weight .. 2 oz.  
Heating time 50 secs.  
Bit Sizes .. 1/16", 3/32", 1/8", 3/16", 1/4"  
Nickel or Iron Plated  
Voltage .. 250 to 12 volts  
Price .. .. . 60/6

### HIGH PRODUCTION INSTRUMENT MODEL H. 150 WATT

Weight .. 6 oz.  
Heating time 1 min. 45 sec.  
Bit Sizes .. 3/16", 1/4", 3/8", 7/16"  
Nickel or Iron Plated  
Voltage .. 250 to 24 volts  
Price .. .. . 87/6

### OTHER VARI-STAT IRONS:—

Miniature Model M 50 watt Push-in Bits 1/32", 1/16", 3/32"  
Instrument Model B 70 watt Bit Size 11/64"  
Industrial Model I 500 watt Bit Size 5/8"

## CARDROSS ENGINEERING CO., LTD.

Woodyard Road, Dumbarton

Phone: Dumbarton 2655

WW—080 FOR FURTHER DETAILS



STOCKISTS



MULTIMETER MK. IV

### REPAIR SERVICE 7-14 DAYS

We specialise in repair, calibration and conversion of all types of instruments, industrial and precision grade to BSS.89.

Release notes and certificates of accuracy on request.

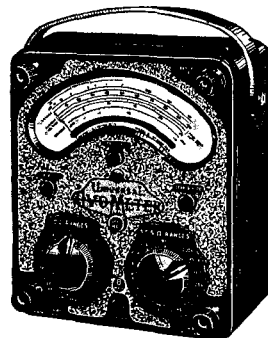

MODEL 8 MK. III

Suppliers of Elliott, Cambridge and Pye instruments

## LEDON INSTRUMENTS LTD

76-78 DEPTFORD HIGH STREET, LONDON, S.E.8

Tel.: 01-692 2689

E.I.D. & G.P.O. APPROVED

CONTRACTOR TO H.M. GOVT

WW—081 FOR FURTHER DETAILS

Designers and project engineers,  
 reduce your power unit selection problems, with  
 the unique A.P.T. SERIES 30 SLIDE RULE.  
 Specially designed to show at a glance, voltage,  
 current, dimensions, model number and prices.  
 Withdraw the slide from the sleeve for  
 ordering details, specifications including  
 performance, remote sensing,  
 overload protection, temperature,  
 input etc. Write today for your  
 FREE slide rule.



**A.P.T. Electronic Industries Limited,**  
**Chertsey Road, Byfleet, Surrey**  
 Telephone: Byfleet 41131 Grams: Aptran, Byfleet.

# Free... power supply selector

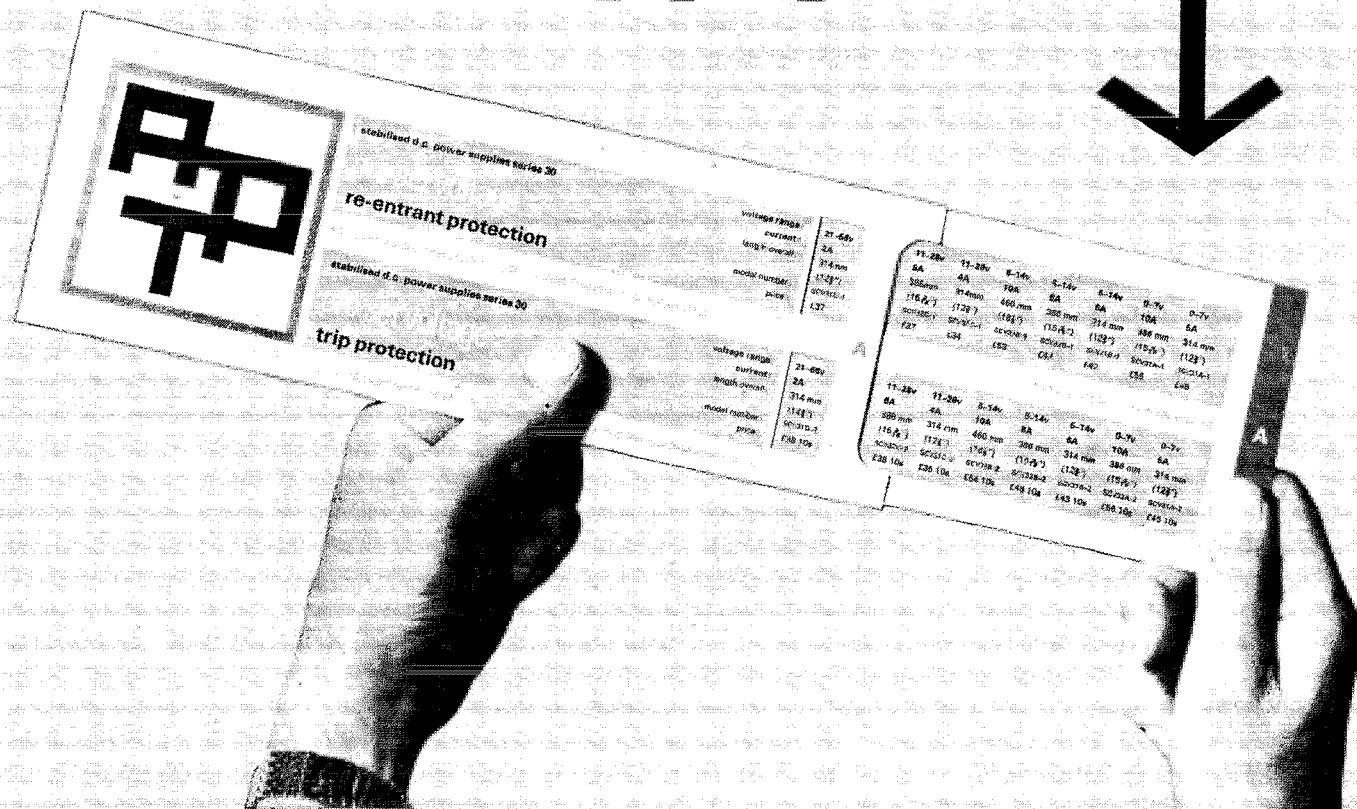

**WE ARE INTRODUCING FIRST CLASS (1.5% ACCURACY) MOVING COIL METERS OF CURRENT MANUFACTURE. THESE STURDILY BUILT INSTRUMENTS HAVE HIGH TORQUE MOVEMENTS AND ARE CAREFULLY ADJUSTED FOR CORRECT AMOUNT OF DAMPING**

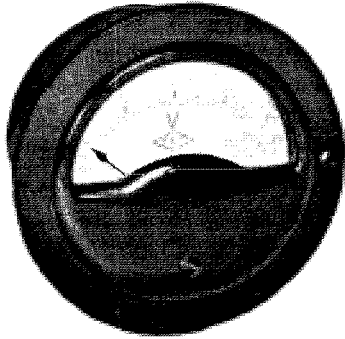

The Meters are calibrated for use on anti-magnetic panels, in vertical position.

At present only the sizes listed below are available ex-stock. We hope to increase the range in the near future to include further sizes and types.

RANGE	70DA	85DA	120DA
40μA	—	58/-	82/-
60μA	66/-	53/-	78/-
100μA	62/-	49/-	74/-
150μA	—	44/-	—
250μA	54/-	42/-	65/-
400μA	52/-	—	—
600μA	49/-	36/-	60/-
1mA	46/-	—	—
2.5mA	—	—	58/-
25mA	—	—	58/-
40mA	46/-	34/-	—
60mA	—	—	—
100mA	—	34/-	—
150mA	46/-	—	—
250mA	46/-	34/-	—
400mA	46/-	—	—
600mA	46/-	34/-	—
1A	46/-	—	58/-
1.5A	—	—	58/-
2.5A	—	—	58/-
4A	46/-	35/-	—
10A	—	35/-	60/-
40A	—	39/-	64/-

Type 70DA and 70DV. 80mm. square flange. Flush mounted 68mm. dia. body. 40mm. depth from the panel.

Type 85DA and 85DV. 85mm. dia. flange. Flush mounted. 67mm. dia. body. 48mm. depth from the panel.

Type 120DA and 120DV. 120mm. square flange. Flush mounted. 68mm. dia. body. 40mm. depth from the panel.

RANGE	70DV	85DV	120DA
6V	82/-	—	—
10V	—	40/-	—
15V	—	—	62/-
25V	—	40/-	—
40V	82/-	—	—
60V	82/-	—	68/-
100V	—	—	62/-
150V	82/-	46/-	—
200V	53/-	46/-	65/-
400V	—	47/6	69/-
600V	58/-	50/-	77/-

**Z & I AERO SERVICES LTD.**  
**44A WESTBOURNE GROVE, LONDON, W.2**

Tel: PARK 5641/2/3

Cables: ZAERO LONDON

Telex: 261306

WW—083 FOR FURTHER DETAILS

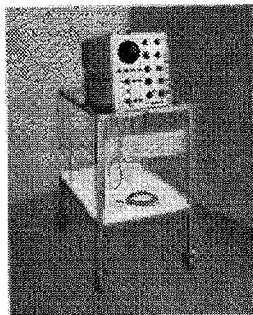

**AVONCEL EQUIPMENT TROLLEYS**

Medium Duty from £17. Heavy Duty from £35. Wide range of Standard Models. Quick Delivery Special Models made to order.

**"AVONCEL"**

**AVON COMMUNICATIONS & ELECTRONICS LTD**  
 318 BOURNEMOUTH (HURN) AIRPORT  
 CHRISTCHURCH, HANTS. Tel. NORTHBOURNE 3774 (P.B.X.)

WW—084 FOR FURTHER DETAILS

**DIOTESTOR IN-CIRCUIT TRANSISTOR TESTER**

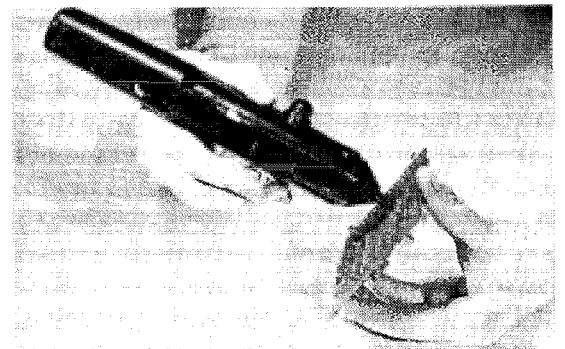

**BRITEC LIMITED, 17 Charing Cross Road, London, W.C.2**  
 Tel: 01-930-3070

WW—085 FOR FURTHER DETAILS

**f'rinstance...**

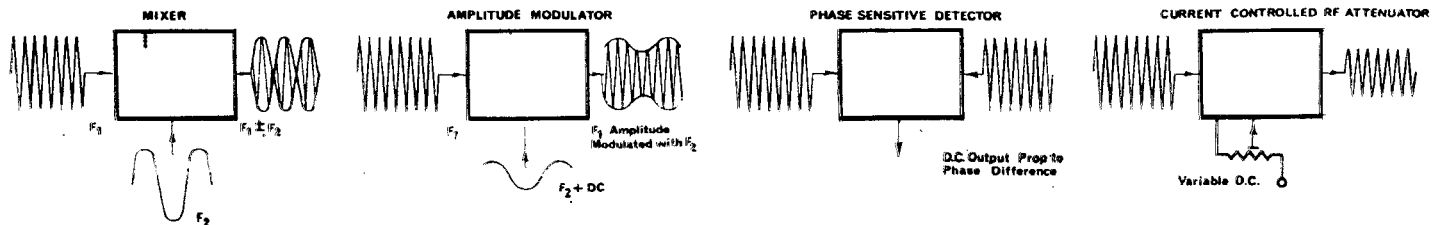

New, versatile Hatfield Modulators Types MD4 and MD6 have been designed using the latest Schottky barrier diodes. The superior wideband match and low noise characteristics of these components enable a very high performance to be obtained. The diagrams below illustrate some of the typical uses for these new units, which also have applications in phase lock loops.

Write now for detailed Data Sheets.

SOUTH-EAST ASIA—for prompt service and deliveries contact HATFIELD INSTRUMENTS (NZ) LTD., P.O. Box 717, Napier, New Zealand.

**HATFIELD BALUN**

**HATFIELD INSTRUMENTS LTD.,**  
 Dept. WW, Burrington Way, Plymouth, Devon.  
 Telephone: Plymouth (0752) 72773/4.  
 Telegrams: Sigien Plymouth.

WW—086 FOR FURTHER DETAILS

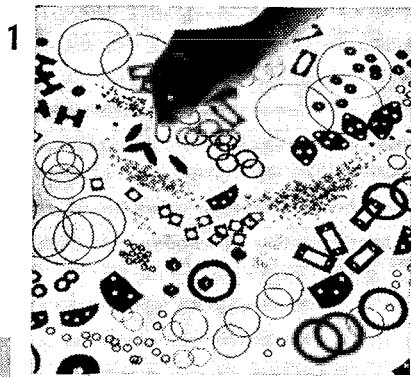

Everything  
you need for  
precision  
soldering  
from  
Enthoven

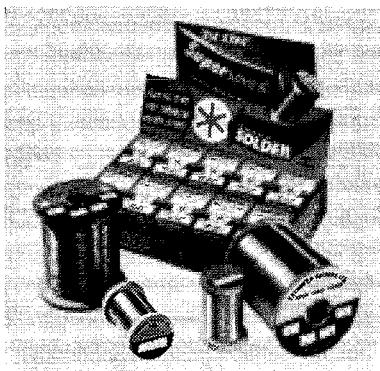
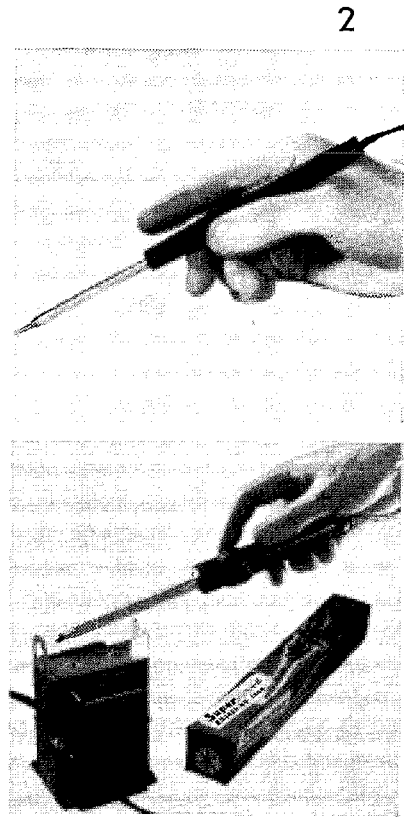

4

3

5

**Tools, materials and knowledge.** Two of the neatest irons ever made. The finest, most reliable materials—backed by over 150 years' experience of smelting and refining non-ferrous metals. And intimate knowledge of modern soldering techniques, the product of special experience built up over the years confirmed when necessary in one of Europe's most advanced metallurgical laboratories. This is what Enthoven offer you. **1** Washers and preforms, cored and solid, standard and special. **2** Microscope soldering iron for fine work. **3** Superspeed six-second heat soldering iron. **4** Preservative, metal, Tricene-de-oxidant, lacquer, flux, and thinners for printed circuits. **5** Super-speed solder . . . stellate cored, wide range of alloys, gauges and packings.

New free booklet describes the complete range of Enthoven Solder products. Ask now for your copy of 'Soldering with Enthoven.'

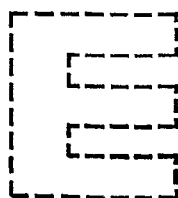

**ENTHOVEN**  
SOLDERS LIMITED

Head Office and Sales Office

Dominion Buildings South Place London EC2

Telephone: 01-628 8030

WW-087 FOR FURTHER DETAILS

## D.C. RELAY TYPE R.3 TWIN

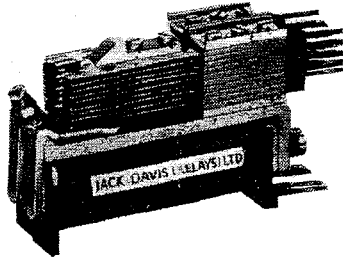

Twin coils and armatures.  
Two completely independent relays in one.  
A space and money saver!

## MECHANICAL RELAY LATCH

Enables the P.O. 3000 type relay to be held in the closed position when the coil is de-energised and until manually released. Does not impair the versatility of the contact arrangements, nor affect the normal mounting position.

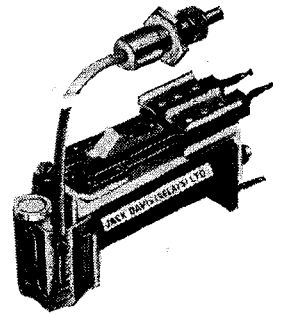

RELAYS

## THE REMANENCE RELAY

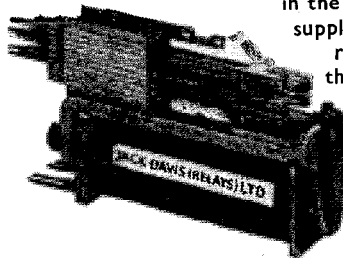

This is a 3000 type relay capable of latching in the energised position after the supply is removed until a suitable releasing current is applied in the opposite direction. This releasing current is controlled with a single coil, by reducing the operating current in reverse or with a double coil, via a pair of contacts employed on the relay to energise the second coil.

## ELECTRO-MAGNETIC COUNTERS



**MAJOR TYPE** 6" x 1½" x 1⅜". Counts when coil is energised.  
3V DC—220V DC. Speed approx. 8 per second.



**MINOR TYPE** 4⅜" x 1" x 1". Counts when coil is de-energised  
3V DC 110V DC. Speed approx. 10 per second.

**JACK DAVIS (RELAYS) LTD.** 9/10, Mallow Street, London, E.C.1  
Telephone: CLerkenwell 3661-2

WW—088 FOR FURTHER DETAILS

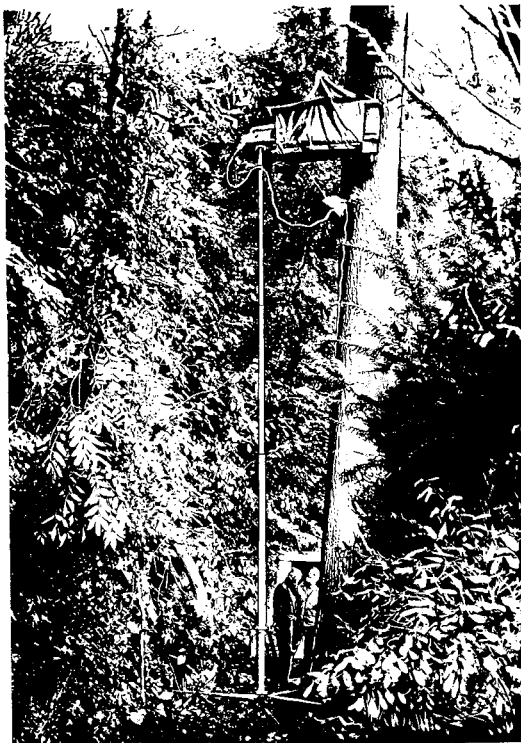

**CLARK**

## AIR OPERATED TELESCOPIC MASTS

A.N. CLARK (ENGINEERS) LTD. BINSTED, ISLE OF WIGHT, ENGLAND.

But if you DO want to raise an aerial of 200 lbs. or to heights in excess of 100' CLARK Air Operated Telescopic Masts can help you do the job. The photograph on the left shows a nine pound TV camera supported by a CLARK QT series mast looking in on a fruit bat's night life. Should you have a telescopic mast requirement CLARK offer you the world's most versatile range of vehicle born, free-standing or trailer mounted masts.

Thirty countries use our masts and users range from airport authorities, police and armed forces to . . . fruit bat watchers.

Whatever the occasion a CLARK mast will rise to it. Write for further details.

A Super E QT 4 mast extended, mounted on a Ford Cortina Estate.

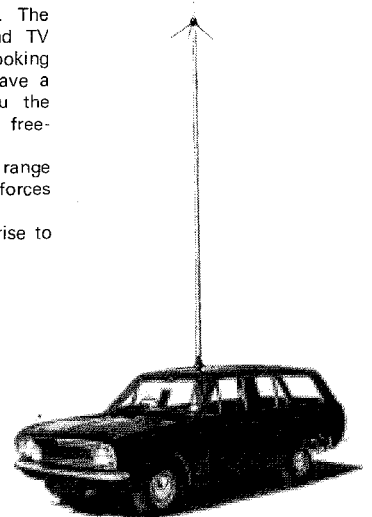

**so who wants to study fruit bats ?**

WW—089 FOR FURTHER DETAILS



# LEVELL

## PORTABLE INSTRUMENTS

### R. C. OSCILLATORS

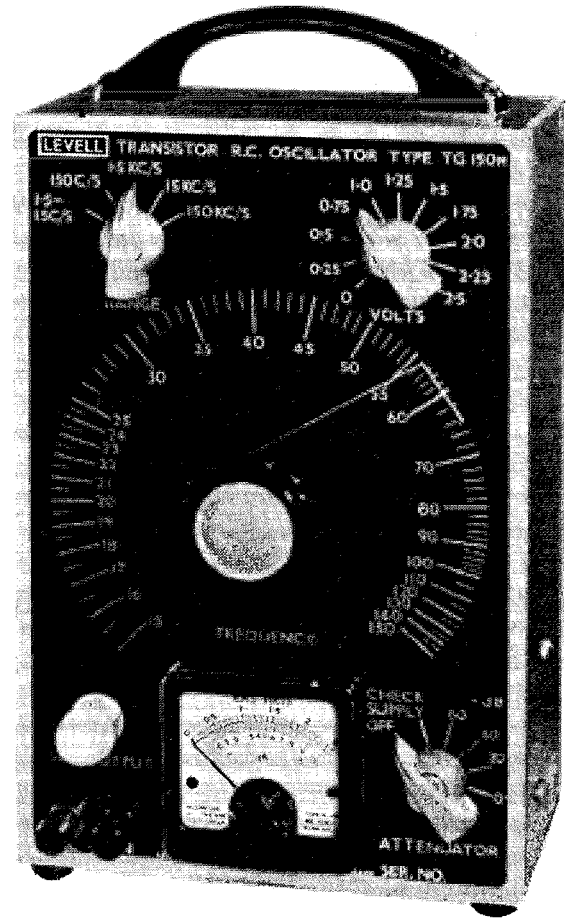

With **DIGITAL** or **ANALOGUE** frequency calibration

TYPE	TG66A	TG66B	TG150	TG150M	TG150D	TG150DM
FREQUENCY	0.2 Hz to 1.22 MHz.		1.5 Hz to 150 kHz			
ACCURACY	$\pm 0.02$ Hz below 6 Hz $\pm 0.3\%$ from 6 Hz to 100 kHz $\pm 1\%$ from 100 kHz to 300 kHz $\pm 3\%$ above 300 kHz		$\pm 3\% \pm 0.15$ Hz			
DISTORTION	$< 0.15\%$ from 15 Hz to 15 kHz $< 0.5\%$ at 1.5 Hz and 150 kHz		$< 0.1\%$ at 1 kHz, $< 0.3\%$ from 50 Hz to 15 kHz $< 1.5\%$ below 50 Hz and above 15 kHz.			
SINE WAVE OUTPUT	Source voltage variable from $30\mu\text{V}$ to 5V. Output impedance $600\Omega$ at all settings.		Source voltage variable from $250\mu\text{V}$ to 2.5V, Output impedance $< 250\Omega$ above $250\text{mV}$ , $600\Omega$ below $250\text{mV}$ . Less than 1% variation of amplitude throughout frequency range.			
SQUARE WAVE OUTPUT	None		None		Variable up to 2.5V peak. Rise time 1% of period + $0.2\mu\text{s}$ .	
OUTPUT METER	Expanded voltage scales and $-2\text{dB}$ to $+4\text{dB}$ . Scale length 3.5"		None	0 to 2.5V and $-10\text{dB}$ to $+10\text{dB}$	None	0 to 2.5V and $-10\text{dB}$ to $+10\text{dB}$
POWER SUPPLY	4 type PP9 batteries, life 400 hours, or, A.C. Mains when selected by panel control		2 type PP9 batteries, life 400 hours, or, A.C. Mains when batteries are replaced by Levelle Power Unit.			
SIZE	7" x $10\frac{1}{4}$ " x 7" Weight 12 lb.		10" high x 6" wide x 4" deep. Weight 6 lb.			
PRICES	£150	£120	£32	£42	£35	£45
+ Mains Power Unit	included	£15	£7 10 0			
+ Leather Case	£5	£5	£4 10 0			

**LEVELL ELECTRONICS LTD., Park Road, High Barnet, Herts. Phone 01-449 5028**

WW-090 FOR FURTHER DETAILS

# MINILAMPS

## MAKE LIGHT WORK OF IT!

Are you using Minilamps? You should be! These low voltage indicator lamps are inexpensive to buy and install and do a wonderfully efficient job. That's why they're in use throughout the world, from ships to computers. See how Minilamps save you time and costs. In all these ways:

### MINILAMPS ARE FRONT MOUNTED

No more mounting problems! No need for access to rear of mounting panel.

### THEY'RE SO EASY TO INSTALL

Wired in seconds, using standard A-MP connectors. Just a push and a Minilamp is mounted. And firmly held by a special nylon grommet. Replacement is just as easy.

### NYLON ENCAPSULATED TO LAST AND LAST

Minilamps have a life equal to standard filaments. They don't discolour or deteriorate in use.

### AND THEY'RE APPROVED FOR SAFETY

Approved by the Home Office for security alarms and by the National Coal Board for use in mine safety equipment and other hazardous applications.

### THERE'S A CHOICE OF COLOURS

White, red, yellow, blue or green. Others to special order. Voltages are 6, 12 and 24.

Get the facts about Minilamps, used by the thousand in the electrical and electronics industries.

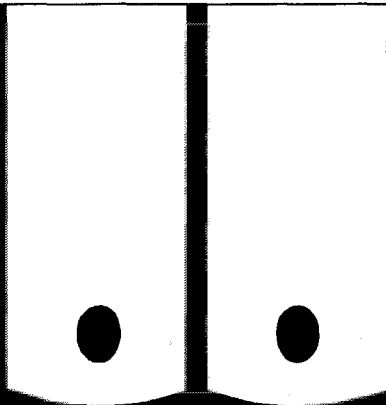

# MINILAMPS MAKE LIGHT WORK OF IT!

For full technical data, samples & quotations, write to:

**FieldTech Ltd** London Airport · Hounslow · Middlesex  
Telephone: SKYport 2811.

WW—091 FOR FURTHER DETAILS

# Faithful Reproduction

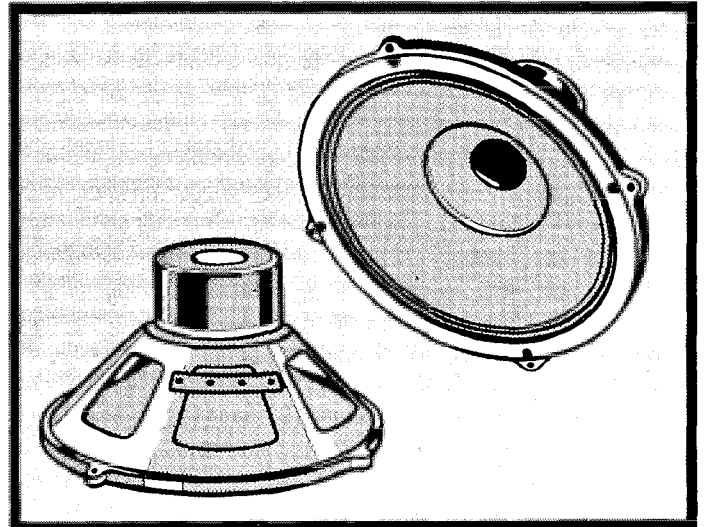

## with the Grampian TC12 loudspeaker

The Grampian TC12 loudspeaker is a high quality twin cone unit at a reasonable price. The loudspeaker is built of high quality materials to a rigid specification and is eminently suitable for good quality sound reproduction. Let us send you full details or better still go and hear one at your local dealers now.

Design for suitable cabinet available.

Grampian manufacture high grade microphones, parabolic reflectors, windshields and accessories, also mixers and amplifiers.

**Grampian** SOUND EQUIPMENT  
Integrity that you hear

Send for leaflet giving full details

**GRAMPIAN REPRODUCERS LTD**

Hanworth Trading Estate, Feltham, Middlesex  
Tel: 01-894 9141/3 Cables REAMP, FELTHAM

WW—092 FOR FURTHER DETAILS

# ONE....

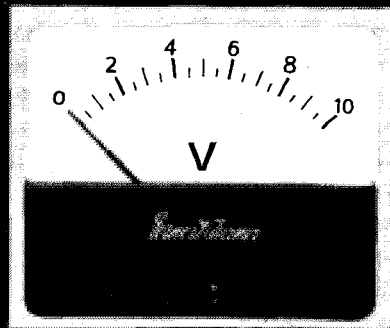

# ...OR A THOUSAND

To your specification....with quick delivery

# AND *Ernest Turner* RELIABILITY

Whether your need is for a single instrument or a thousand (or even more) the Ernest Turner organisation is geared to give the same renowned service. From a very wide choice of movements and case styles we can provide precisely the instrument for your application, including the manufacture of special dials and provision of built-in or external units to permit indication of any electrical quantity.

We invite your specific enquiry for any number of instruments from one upward, and we should be pleased to send you a copy of our general catalogue 86/25 on request.

**ERNEST TURNER ELECTRICAL INSTRUMENTS LTD.**  
HIGH WYCOMBE - BUCKINGHAMSHIRE - ENGLAND. Tel: High Wycombe 30931

# RE-CREATES THE FINER SHADES OF ORIGINAL SOUND

To re-create faithfully the finer shades of original sound, stored as complex mechanical patterns in the micro-grooves of modern records, calls for a cartridge in the precision instrument class. Goldring engineers have spent two years developing such a cartridge... the Goldring "800E" Free Field Cartridge with elliptical diamond stylus. At a comparatively modest cost this cartridge rivals the finest in the world, whilst at the same time guaranteeing the complete reliability for which the name "Goldring" has stood for sixty years in record reproduction.

## GOLDRING '800 E' FREE FIELD STEREO CARTRIDGE

**GOLDRING "800E" FREE FIELD  
STEREO CARTRIDGE £18.10.6**

tax paid

### SPECIFICATION

Type	Magnetic—(Free Field)
Frequency Response	10 Hz—25 kHz
Sensitivity	1 mv. per cm/sec.
Separation	25dB at 1kHz
Load	100k—47k/ohms
Compliance	30 x 10 <sup>-6</sup> cm/dyne
Stylus	0.0008" x 0.0003" diamond replaceable
Effective Tip Mass	Less than 1 mg.
Tracking Weight	0.75—2gm.
Head Weight	8 grms.
Vertical Tracking Angle	15°
Mu Metal Shield for hum protection.	

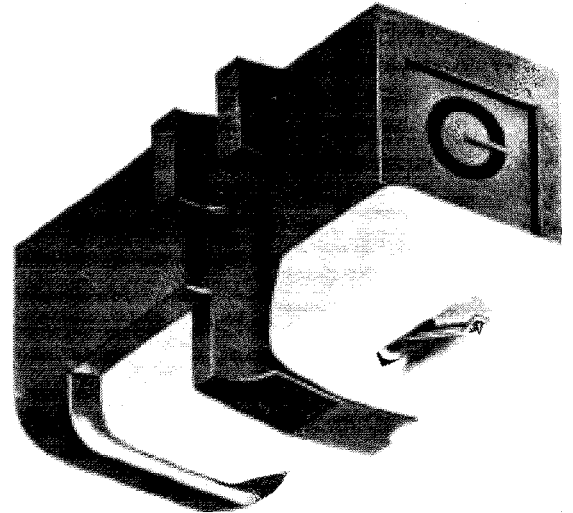

**GOLDRING MANUFACTURING CO. (GREAT BRITAIN) LIMITED 486-488 High Road, Leytonstone, London, E.11. Tel: Leytonstone 8343**

**WW—094 FOR FURTHER DETAILS**



Aspects of S.N.S.

## No.1 New Radiomicrophones

S.N.S. are proud to announce the first British made G.P.O. approved Radiomicrophone to sell complete, Transmitter, Receiver, Carrying Case and microphone, at under £100.

This unit known as the Type 12 Mk II joins the range of systems which have proved their worth over the past 4 years, including both wide and narrow band systems, special studio systems developed for Broadcasting and T.V. Authorities and used extensively in the Film Industry.

Because of this wide range and our ability to meet customer "specials" at a reasonable cost we have been increasingly successful in this field, quite apart from the other aspects of S.N.S. and are now able to offer this new system, designed for both good looks and optimum performance, at a really reasonable cost.

We are always pleased to arrange demonstrations and provide quotations against your requirements and would ask you to note the wide range of our products noted below, which enable us to engineer complete sound systems of any size and complexity.

For further details on the new Type 12 Mk II, or any other of our products please write, phone or telex.

**J.V.H. ROBINS, Marketing Director S.N.S. Communications Limited,  
Tropical Works, 851 Ringwood Road, West Howe, Bournemouth, Hants, England.  
Telex 41224. Tel: Northbourne 4845.**

**Manufacturers of: Transistor Amplifiers, Crystal AM and FM tuners, cabinet and line source loudspeakers, Loudspeaking Intercom Systems, Hotel Radio and Intercom Systems.**

# TOWNLEY

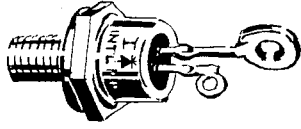

## INTERNATIONAL RECTIFIER

Quality Semi-Conductors.  
Complete Rectifier Assemblies up to thousands of Amps, Diodes, Thyristors, Zeners, Encapsulated Bridges, Photocells, Klipsel Surge Protectors.

For experiment and teaching:—  
ZENER KITS, THYRISTOR KITS.

Bulletins and prices on request.

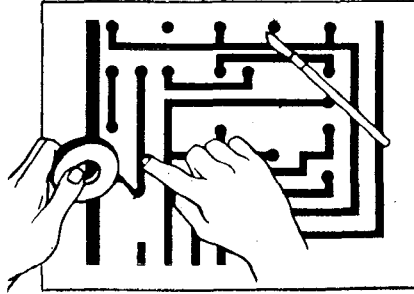

## PRINTED CIRCUIT DRAFTING AIDS

Save drafting time and costs. Self-adhesive shapes and tapes. Terminal circles—fillets—tees—elbows—universal corners and mounting holes.

Bulletins and prices on request.

## ENGLISH ELECTRIC



### GS FUSES

for the protection of rectifiers and thyristors.

Bulletins and prices on request.

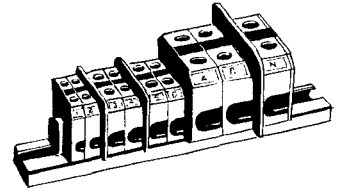

Rail Mounted Terminals and Terminal Blocks 0-5-250 Amps.

Bulletins and prices on request.

COMPONENTS DEPARTMENT

**PHONE TODMORDEN 2601**

AND ASK FOR EXTENSION 1

WW-096 FOR FURTHER DETAILS TO COMPONENTS DEPT ONLY

HARMSWORTH, TOWNLEY & CO TODMORDEN LANC'S

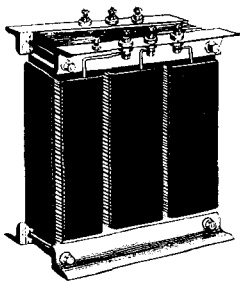

## TRANSFORMERS

0-25 kVA to 300 kVA  
1 phase and 3 phase

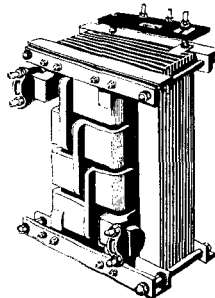

## LOW VOLTAGE HIGH CURRENT TRANSFORMERS

with output currents of hundreds, thousands and tens of thousands of amps.  
1 phase and 3 phase.

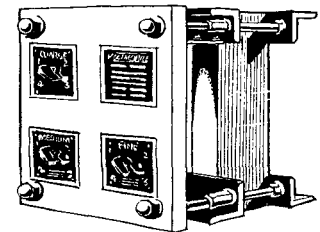

## VOLTMOBILES

64 steps on load switching Auto-Transformers. 1 phase and 3 phase. 200-400 Amps.

Zero to 100% Volts or 125% of Input Volts.

Voltmobiles are low-cost controllers, for furnaces, rectifier sets and other loads.

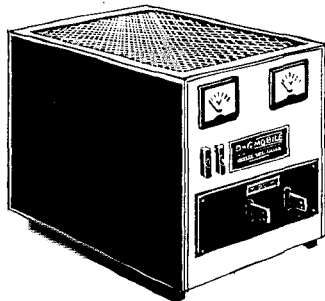

## DC POWER SUPPLIES

For Magnets, Accelerators, Plating, Anodising, Spectroscopy, Plasma Arc, Toronto Arc, Electron Beams, Electrolysis, Welding, Quartz Lamps, Mercury Vapour Lamps. From 100 W to 200 kW.

LET US HAVE YOUR SPECIFIC REQUIREMENTS

EQUIPMENT DEPARTMENT

**PHONE TODMORDEN 2601**

AND ASK FOR EXTENSION 3

# a complete range of OSCILLOSCOPES for the test engineer

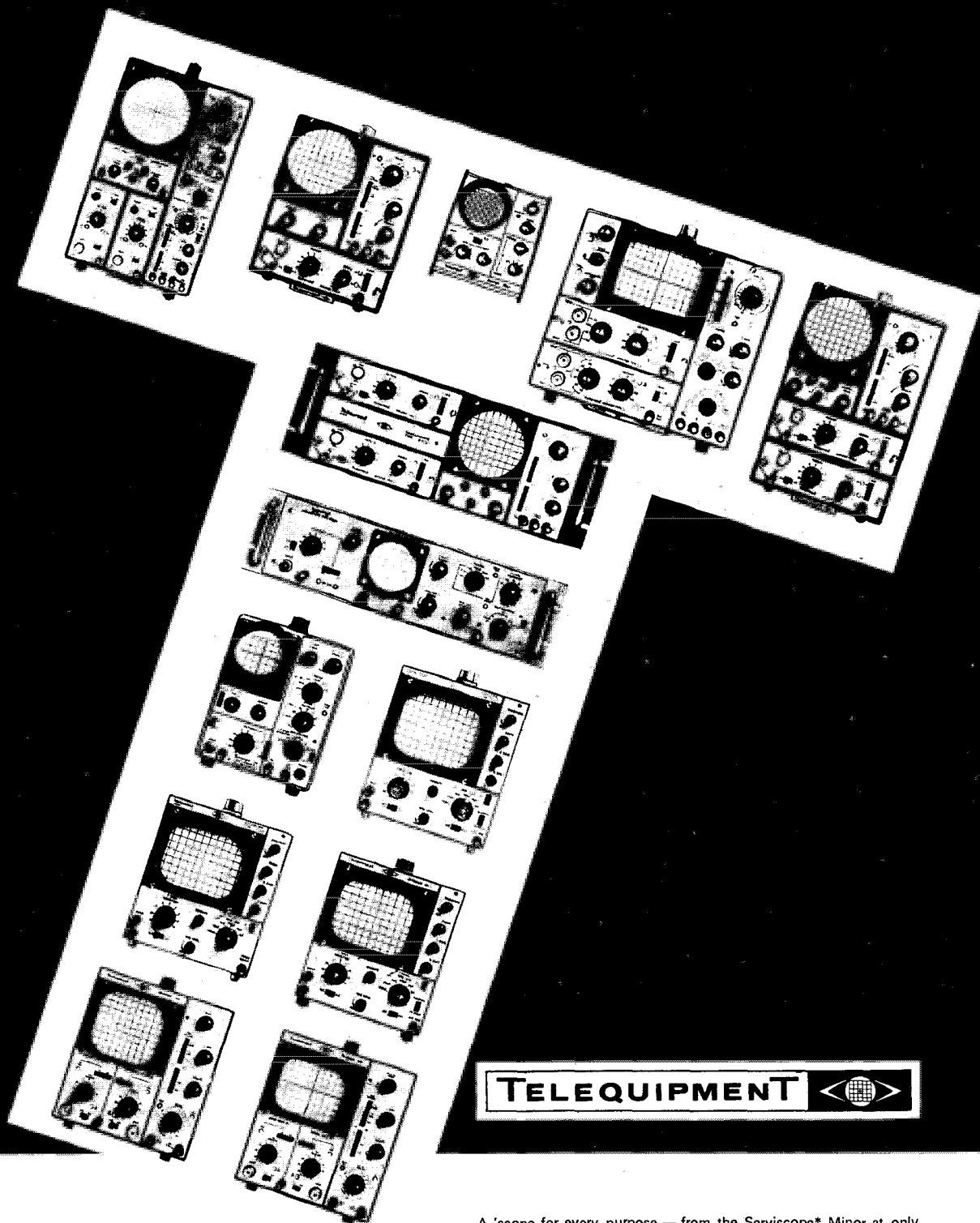

**TELEQUIPMENT**



*A copy of the Telequipment Short Form Catalogue is all ready to be posted to you — just let us have your name and address direct or via the Reader Enquiry Card.*

A 'scope for every purpose — from the Serviscope\* Minor at only £23.10.0. to the sophisticated double-beam D53 for laboratory use. A comprehensive range of accessories is available, and certain Telequipment oscilloscopes can also be supplied for rack mounting.

## TELEQUIPMENT LIMITED

*\*Serviscope is a registered trade mark of Telequipment Ltd.*

313 Chase Road · Southgate · London, N.14 · Telephone: 01-882 1166

WW—097 FOR FURTHER DETAILS

# Wireless World

Electronics, Television, Radio, Audio

Fifty-eighth year of publication

June 1968

Volume 74 Number 1392

## Contents

- 143 **Constructional Projects**
- 144 *Wireless World* Colour Television Receiver
- 147 **Space Communication and Travel**
- 148 **Loudness Control for a Stereo System** by R. T. Lovelock
- 151 **Colour TV Development Continues in Europe**
- 153 **Conferences and Exhibitions**
- 154 **Output Transistor Protection in A.F. Amplifiers** by A. R. Bailey
- 156 **Interference and Microwave Systems**
- 157 **News of the Month**
  - Applying "Bosworth" in Semiconductors
  - G.A.D.—The Printed Transistor
  - B.O.A.C. Flight Booking System
- 160 **Personalities**
- 161 **Test Your Knowledge** questions & answers by L. Ibbotson
- 162 **Letters to the Editor**
- 165 **Decade Frequency Standard** by K.-V. Weisberg
- 166 **Hybrid Cascode Amplification** by B. Alvesten & L. Bergsten
- 168 **Announcements**
- 169 **Audio Fair Review**
- 176 **Television Camera Tubes** by I. R. Sinclair
- 179 **Demonstrating A. C. Theory** by J. A. Assenheim
- 180 **Manufacturing Colour Tubes**
- 181 **Series Voltage Stabilization** by J.-E. Sigdell
- 182 **Hanover Fair Grows Internationally**
- 183 **New Products**
- 186 **High-frequency Analogue Multiplier** by M. E. Whatton & G. Crisp
- 188 **World of Amateur Radio**
- 190 **Literature Received**
- 190 **H.F. Predictions**

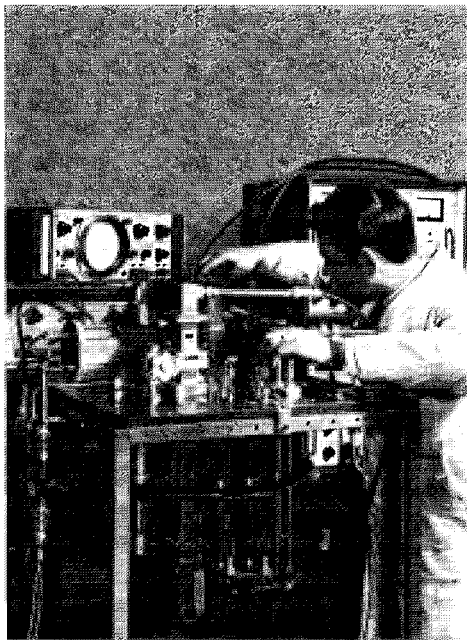

**This month's cover.** A development engineer at Mullard's Mitcham works adjusts a cooled two-stage parametric amplifier designed for use as a low-noise r.f. input stage in communications satellite earth stations. The amplifier operates at 4GHz with a bandwidth of 500MHz, and has a gain of 40dB and an overall noise temperature of 20°K.

Iiffe Technical Publications Ltd.,  
Managing Director: Kenneth Tett  
Editorial Director: George H. Mansell  
Dorset House, Stamford Street, London, SE1

© Iiffe Technical Publications Ltd., 1968

Permission in writing from the Editor must first be obtained before letterpress or illustrations are reproduced from this journal. Brief extracts or comments are allowed provided acknowledgement to the journal is given.

*PUBLISHED MONTHLY* (3rd Monday of preceding month). Telephone: 01-928 3333 (70 lines). Telegrams/Telex: Wiworld Iiffepres 25137 London. Cables: "Ethaworld, London, S.E.1." Annual Subscriptions: Home; £2 6s 0d. Overseas; £2 15s 0d. Canada and U.S.A.; \$8.00. Second-Class mail privileges authorised at New York N.Y. Subscribers are requested to notify a change of address four weeks in advance and to return wrapper bearing previous address. BRANCH OFFICES: **BIRMINGHAM:** 401, Lynton House, Walsall Road, 22b. Telephone: Birchfields 4838. **BRISTOL:** 11 Marsh Street, 1. Telephone: Bristol 21491/2. **COVENTRY:** 8-10, Corporation Street. Telephone: Coventry 25210. **GLASGOW:** 123, Hope Street, C.2. Telephone: Central 1265-6. **MANCHESTER:** 260, Deansgate, 3. Telephone: Blackfriars 4412. **NEW YORK OFFICE U.S.A.:** 300 East 42nd Street, New York 10017. Telephone: 867-3900.

# CONSUMER

# ELECTRONICS

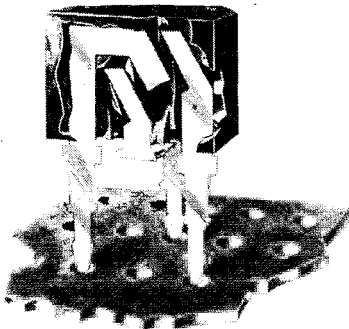

## Lock-fit transistors stay where they're put

Putting transistor leads through boards, cropping them and hoping they'll stay put until soldered is out of date. Now just push a Lock-fit transistor in and it stays there. The leads are shaped to grip.

And they won't bend or break. They're designed to pop straight into standard printed circuit grids and p.c. boards of both standard thicknesses. The transistor itself—many of the

wide range of Mullard silicon types—is protected in an epoxy encapsulation which gives good heat conduction. The special epoxy used by Mullard maintains the low spreads of the silicon chip. The shape ensures that operators or machines put the transistor into equipment the right way round. So Lock-fit is easy to mount, gives better solderability and simplifies handling. Lock-fit will save you assembly time and costs. For the full Lock-fit range story manufacturers should tick the coupon.

## You may think capacitors inexpensive. But have you worked out the cost of a dud on your line?

We're not going to start the old price v. quality argument again. We'd just like to make sure that you're getting the whole picture. It's up to you to judge what's right for your particular job. But Mullard will help you as much as possible. So bear in mind that, as well as price and technical information, Mullard can also give you the most detailed life/performance data.

This information is fundamental to us if our AQL\* is to be maintained—how else could we improve our products? And this information is available to you. Take electrolytics for example. We found that they represent about 70% of all capacitor failures in the life of a TV set. So we produced a detailed report and recommendations on the best way to use electrolytics. You're welcome

to a copy—it covers polyester capacitors too. Just tick the coupon. By getting all the information before you select you can be really sure that you are going to make *savings* by choosing the particular component to meet your design parameters.

\*AQL= Acceptable Quality Level.

## Time well spent

There can't be many firms who've been in business as long as we have who have used the time to such advantage. Our past experience guides our future plans; provides us with an insight into the industry we serve; allows us to anticipate needs and deploy our resources over the most fruitful areas of research and

development—and thereby provide modern, technically excellent products ready for the demands of tomorrow. We have co-operated in

so many consumer electronics projects that it's quite likely we are working along similar lines to yours. So why not get in touch?

# Mullard

CONSUMER ELECTRONICS DIVISION

Please send me  
Lock-fit transistor information  Capacitor report

Name \_\_\_\_\_  
Position \_\_\_\_\_  
Company \_\_\_\_\_  
Address \_\_\_\_\_

Mullard Limited, Consumer Electronics Division, Mullard House, Torrington Place,  
London W.C.1.

WW 5

CED55



# Wireless World

## Constructional Projects

**Editor-in-chief:**

W. T. COCKING, F.I.E.E.

**Editor:**

H. W. BARNARD

**Technical Editor:**

T. E. IVALL

**Assistant Editors:**

B. S. CRANK

J. H. WEADEN

**Drawing Office:**

H. J. COOKE

**Production:**

D. R. BRAY

**Advertisements:**

G. BENTON ROWELL (*Manager*)

J. R. EYTON-JONES

Although the final analysis of our recent reader interest survey is not yet available—it was essential to await replies from overseas readers who, incidentally, number one in five—one thing is very obvious from the comments and accompanying letters received: there is still a tremendous interest in constructional projects. It is, however, necessary to qualify this interest as readers made it blatantly plain that they do not want gimmicky electronic gadgets but worthwhile projects. *Wireless World* has for more than 40 years had a very strong following of 'do-it-yourself' enthusiasts, and as older readers will remember there were few issues, even when weekly, that did not include details of a receiver, or some item for home construction. In those far-away days, of course, it was cheaper to make than to buy a ready made receiver. Although this is, in general, no longer true the interest in constructional projects has continued and is by no means confined to those of our readers who have a purely amateur interest. This is amply borne out by the fact that professional readers frequently make use of *W.W.* designs in professional equipment—and sometimes they appear on the market as commercial products!

While readers have applauded the inclusion of such designs as the Dinsdale and Bailey amplifiers, some have complained of the paucity of designs 'with the hall mark of the *Wireless World* laboratory'. In self defence we must point out that, whereas in industry a whole team of engineers will devote months or even years to the development of a project, we with a small editorial team (whose prime function is to produce a journal every month) are also expected to develop sophisticated pieces of equipment and then to describe them in sufficient detail to enable readers to build them. It will be obvious therefore, that the number of *W.W.* designs must inevitably be very limited.

For many months past W. T. Cocking, who was responsible for the design of the *Wireless World* monochrome television receiver published in 1947, has been perfecting constructional details of a colour receiver, and the first of a series of articles will be found elsewhere in this issue. However, we would stress that this project 'is not by any to be enterprised or taken in hand, unadvisedly, lightly or wantonly' (to quote from the Church of England marriage service). Having said that we believe that there will be very many readers who will enjoy the exercise. We would especially commend it to the heads of science departments of schools and colleges who would, we feel sure, find in it a worthwhile project which should have more than academic interest for the students.

In saying this about *W.W.* designs we would not wish it to be thought that we belittle, in any way, the admirable designs submitted by contributors and we are in fact collaborating with some of them to bring to fruition more speedily ideas which we feel would be of particular interest.

One other aspect of circuit design must be mentioned. Although comparatively few articles are published in which full constructional details are given we know that the design data given in many others is used by readers to produce their own equipment (see note on p. 182). It would be true to say that rarely is there an issue in which there is not something for the engineer who wants to 'have a go' at constructing a piece of equipment for some particular aspect of the fragmentary technology we call electronics.

# Wireless World

## Colour Television Receiver

### 1. General considerations

**This article is the first of a series describing a colour television receiver in detail. The receiver is one which has been developed by W. T. Cocking in the *Wireless World* Laboratory and is based upon Mullard design data. It is naturally much more complicated and expensive than a purely monochrome set, and its proper adjustment is not only more difficult but demands the use of more elaborate test equipment.**

It must be emphasised at the start that the construction of a colour television receiver is no easy task. Apart altogether from the magnitude of the constructional work, a good deal of practical experience with black-and-white equipment is essential. The constructor must also possess, or have access to, quite a lot of measuring and test equipment. He must also, of course, understand the principles of colour television. In this connection, the series of articles by T. D. Towers in the January to December 1967 issues of *Wireless World* must be regarded as compulsory prior reading.

The final anode of the cathode-ray tube of a colour set normally operates at 25kV. High-voltage insulation problems arise, therefore, and certain safety precautions must be taken. Because of the high voltage, X-rays are generated in one valve and, to a smaller degree, in the c.r.t. itself. Since X-rays can be a danger to health, it is necessary to include proper screening against them. It must be strongly emphasised that the constructor must exercise proper care in the construction and use of the equipment and must never take short cuts by omitting safety precautions.

No danger arises in the normal use of the receiver. It is in initial setting up and in fault-finding that the possibility of danger arises, simply because one is then very close to the apparatus.

A further difficulty which may confront the intending constructor is that of obtaining some of the components. It is not possible to construct a colour receiver using only parts which are readily available on the retail market. Apart from the colour tube itself, the scanning coils and transformers, the convergence coils and some control coils for them are very definitely 'special to colour'. They are primarily manufactured for, and supplied to, the manufacturers of colour television receivers and their makers do not normally supply them direct to the public. It is hoped that some retailers will make supplies available, but it must be made clear that *Wireless World* can do little or nothing to help any individual who finds difficulty in obtaining parts. Details of suppliers will, of

course, be given where possible. Before purchasing any components, therefore, it is wise to make sure that one can obtain *all* special parts.

The purpose of describing the construction of a colour receiver is primarily educational. It is envisaged that those who build it will be mainly people who in one way or another are engaged in the electronics industry and wish to gain experience with colour television. There is no reason why the amateur who is knowledgeable in television and who has already successfully constructed black-and-white receivers should not attempt it, although he will be doing something more difficult than he has previously tackled. Most definitely, however, it is not for the complete beginner in television.

All this preamble may sound rather discouraging. In fact, it is deliberately intended to discourage those who have not sufficient technical knowledge and proper facilities from attempting it. The total cost of the parts on the retail market is likely to be more than that of a commercial colour set and so the cost of failure to an individual is likely to be important. There are so many parts involved that there is a high probability of finding at least several faulty ones, and of making several wrong connections in the wiring! When one first switches on the completed set, therefore, it will be with the knowledge that there are quite likely to be half a dozen definite faults which will have to be traced before anything approaching good results can be obtained. This is very good educationally, for there is nothing like fault-finding to learn about equipment!

A general block diagram of the colour receiver is shown in Fig. 1. Without the block marked Chrominance Circuits, the equipment will produce a monochrome picture of any colour. Up to the video detector the circuits are conventional, but one has to be rather more fussy about bandwidth than in the ordinary black-and-white set. The video amplifier is more complicated, partly because a 0.6- $\mu$ sec delay line must be included to equalize the transmission times of the luminance and chrominance channels. In the main, however,

it is more complex because it must provide a greater signal output than the ordinary video amplifier. The colour tube needs a video signal drive at the cathode of some 140 volts peak white to sync pulse. This signal is applied directly to the cathode of the red gun and through frequency-compensated potentiometers to the green and blue cathodes, since it is necessary to adjust the drives to the three guns to compensate for variations in individual tubes.

Fundamentally the timebases are the same as those of a black-and-white set, but they operate at higher power because they have to provide much larger scanning currents. This comes about because of the 25-kV final anode voltage of the tube and, in its turn, this is needed because of a basic inefficiency in a shadow-mask tube. The shadow mask intercepts a large part of the beam current of all three guns, current which in a normal tube would be focused on the screen to excite it. As it is, with a maximum beam current of 1.2mA at 25kV the e.h.t. power reaches no less than 30W! It is essential, too, that the voltage be stabilized and the usual practice is to employ a valve connected in shunt with the tube to absorb any current not needed by the tube. When the picture is black and the tube draws no current, the stabilizer takes the full 1.2mA and so dissipates 30W.

Because the tube operates at 25kV, the deflection volt-amperes needed are large. In one sense this is fortunate, since it enables the e.h.t. supply to be generated in the usual way as a by-product of the line scanning; it does mean, however, a high-power line-scan stage. The output valve, for instance, has to pass a peak current of 0.9A at an h.t. supply line of 285V. The mean current is 0.36A so the power input to the line-scan output stage is over 100W. Ventilation problems arise, therefore.

A common commercial practice is to obtain the e.h.t. supply from a valve rectifier fed from an overwind on the line-scan transformer. One disadvantage of this is that it provides another source of X-rays. These are produced whenever electrons strike a target, such as the anode of a valve, with sufficient velocity. X-ray production is usually considered to start at around 15-16kV, so it may occur in some degree even in monochrome sets. It rises rapidly with voltage, however, and at 25kV is quite considerable.

A valve rectifier is not used for the e.h.t. supply in the *Wireless World* receiver, but instead a voltage-multiplier with selenium rectifiers. This completely eliminates X-ray production at this stage. It is still present in the voltage stabilizer, however, and so it is necessary to screen this valve against X-rays. The colour tube itself can generate X-rays because it operates at 25kV. Lead glass is used in its construction and there is an external metal screen covering a large part of the bulb, and these cut down the radiation considerably. In the normal operational use of a colour set there is believed to be no health risk from X-rays at all. There may be some slight risk when one is very close to a set, as one must be in fault-finding, and, to a lesser extent, in adjusting it. The danger lies in total dosage which depends on the product of X-ray intensity and time. The writer considers it would be unwise to work all day

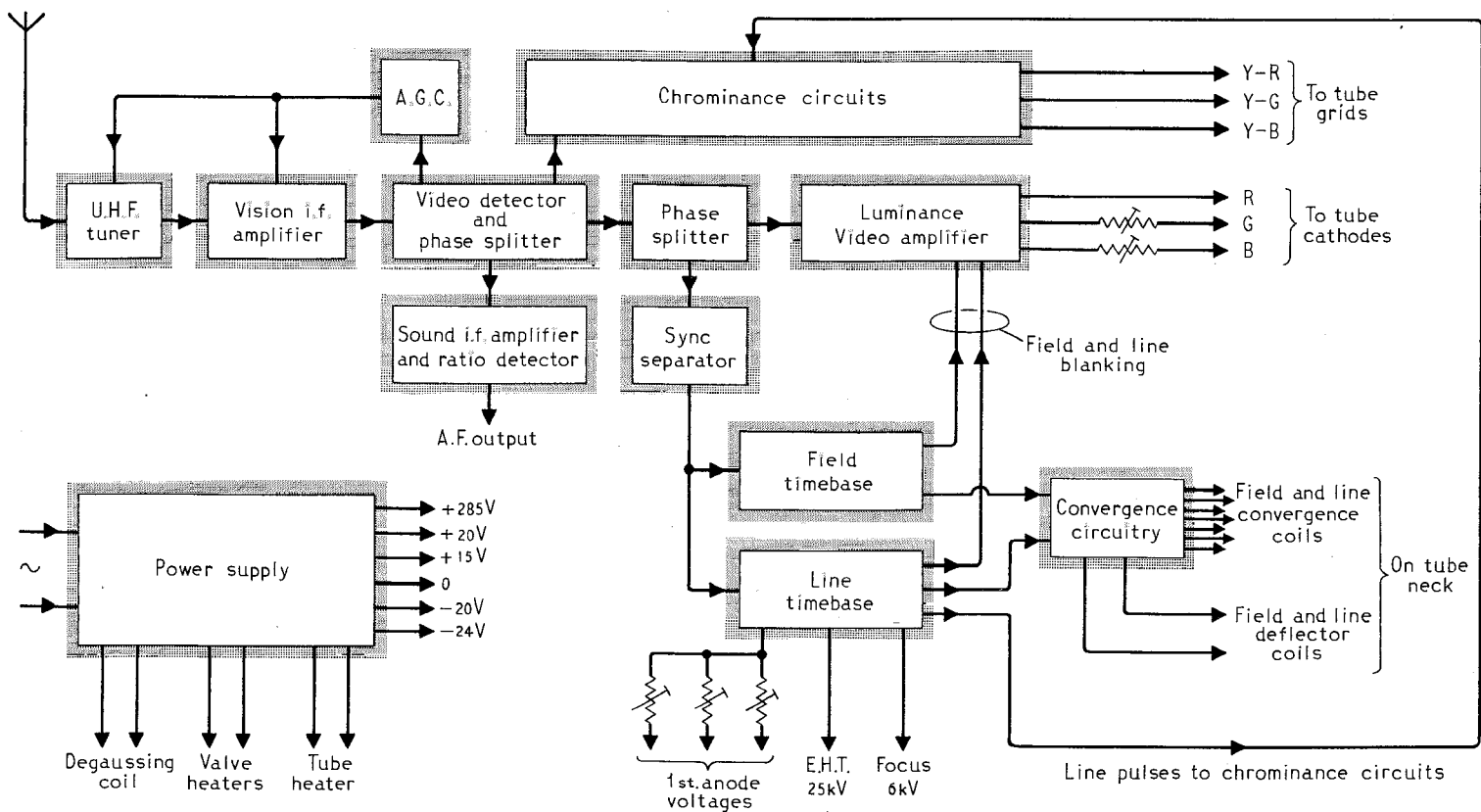

Fig. 1. Block diagram of the colour television receiver. The blocks do not necessarily correspond to physical units. Usually several blocks are contained in a constructional unit.

and every day close to the 'works' of a colour set of this type. This is not necessary, however. Provision is made in the design for the ready disconnection of the h.t. supply to the line timebase. Most fault-finding in circuits other than the line timebase and e.h.t. supply can thus take place with the X-ray producing stages inoperative. Provision is also made for operating the line timebase at reduced output at which the e.h.t. supply is 15kV only and X-ray production is negligible. Under this condition much fault-finding on the line timebase itself can take place in complete safety even if it takes a long time.

To revert to the block diagram of Fig. 1, the main difference from a black-and-white receiver lies in the convergence circuitry. This is necessary to obtain proper superposition of the three pictures produced by the three guns of the tube. The three guns in the tube cannot be situated physically at the same place and it is necessary to deflect their beams in such a way that their deflection by the scanning coils appears to take place from a common centre. Mounted on the tube neck between the deflector coils and the guns is the convergence assembly which comprises six coils and five permanent magnets. Three of the latter are static convergence magnets, the other two are 'purity' magnets. In addition, a further coil and magnet are mounted behind the main convergence assembly; this is usually called the blue-lateral assembly.

The purity magnets are two metal rings transversely magnetized to produce a field across the neck of the tube. The strength of the field can be controlled by rotating one magnet relative to the other; in this way, their fields can oppose or assist each other in any required degree. The direction of the field across the tube neck can be varied by rotating both magnets together.

The purity magnets are normally adjusted with the red gun operative only, and the deflector coil assembly pushed back on the tube neck, to obtain the most pure red in the centre of the screen. The deflector coils are then moved forwards to obtain a uniform red over the whole screen. The purity is then checked for the other colours by putting the other guns on by themselves one at a time.

### Convergence

The other four permanent magnets are next adjusted to secure convergence at the centre of the screen. A cross-hatch pattern generator is almost essential for this. The blue gun is turned off and two magnets are adjusted to superimpose the red and green bars of the pattern at the centre of the screen to produce a yellow pattern. The blue gun is then turned on and the remaining two magnets adjusted to superimpose the blue and yellow patterns in the centre to produce white.

These static convergence adjustments are quite easy to carry out, but they give proper convergence only at the centre of the screen. Away from the centre the red, green and blue patterns produced by the three guns become more and more displaced from each other and it is necessary to carry out dynamic convergence to superimpose them to give a single white pattern.

This is done by feeding currents of special waveforms at line and field frequencies, and derived from the line and field timebases, to the six coils of the convergence assembly and the blue lateral coil. In all there are 14 controls to be adjusted to secure dynamic convergence and during the process some readjustment of static convergence may be

needed. Unfortunately, the settings of many of the controls are interdependent and the newcomer to convergence does not find their adjustment at all easy. The main thing is never to attempt to correct any particular fault completely by one control. Convergence can only be achieved gradually. It is necessary to correct each fault in turn only partially and to keep going over the whole set of controls time after time.

In addition to convergence grey-scale tracking is needed. This is something else which is absent in a black-and-white receiver. The three guns in the tube cannot be identical and adjustments are needed to the relative amplitudes of the video signals applied to their cathodes and to the voltages applied to their first anodes to compensate for their discrepancies. If adjustments are made merely to produce a white raster at full brightness, then instead of dimming off through all shades of grey as the brightness is turned down, the raster will acquire a colour cast. The relative cathode drives and the anode voltages have to be adjusted so that as the raster passes between black and white it does so through all shades of grey.

Before any attempt is made to obtain a colour picture it is essential to obtain a really good black-and-white picture. This may not be quite as good as that given by an ordinary black-and-white receiver; it will almost certainly be less bright and there may be a little colour fringing towards the edges, for perfect convergence is not always obtainable. Apart from this, however, unless the receiver is working perfectly stably and reliably in monochrome, it is a waste of time to try to introduce the chrominance circuits.

We shall not, therefore, discuss the chrominance circuits here, even in outline, and their detailed description will be deferred

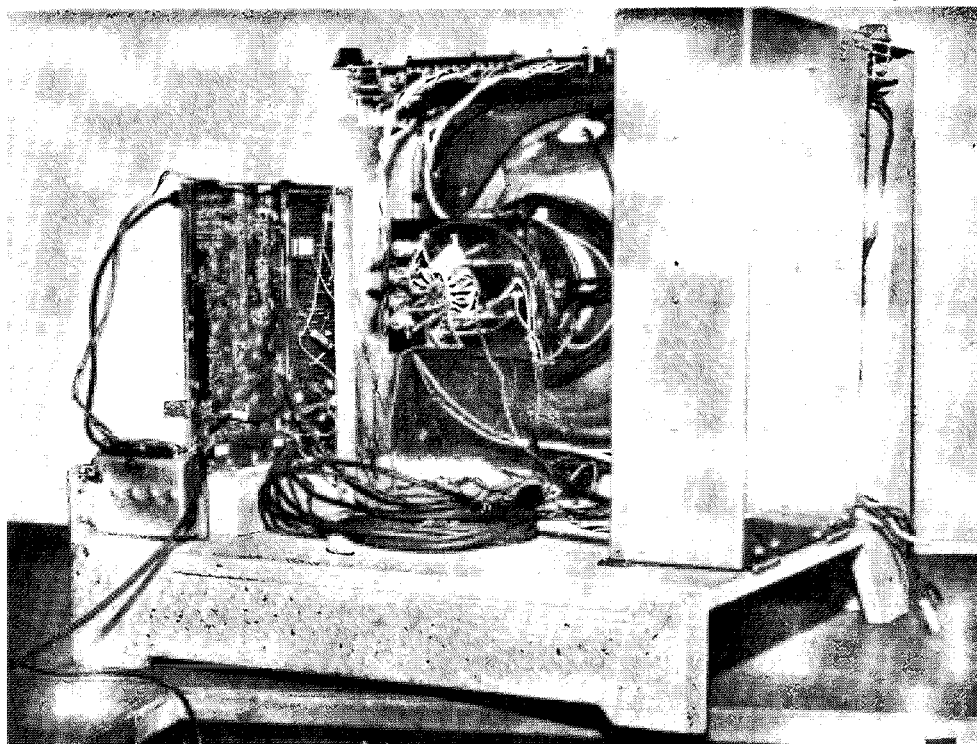

*A rear view of the receiver without the power unit and the colour circuits. The i.f. and video amplifiers are on the left in the photograph with the timebase unit on the right and the convergence controls above the tube.*

until one of the later articles of the series

The *Wireless World* receiver has been built around a 19-inch colour tube. This was chosen in preference to the 25-inch because of its smaller size and weight which made it much more convenient in view of the large amount of handling needed during development. Anyone who wishes to use a larger tube can readily do so, however, for the operating conditions are identical; only two things are different, a larger tube screen and larger degaussing coils are needed. The units containing the circuitry, being made to fit around the smaller tube, can readily be disposed around the larger. One difference in performance may be noted, the larger tube is likely to give a somewhat less bright picture because the same beam power is distributed over a larger area of screen.

A unit construction has been adopted and, apart from the chrominance circuits, the main units are power pack, timebase, convergence, luminance amplifier, i.f. amplifier and tuner. In addition to the deflecting and converging assemblies on the tube neck, there are a few parts mounted on the tube base and degaussing coils are mounted on the tube screen.

It was stated in the announcement in last month's issue that no provision is made for 405-line reception. This has been done chiefly for simplicity, since the switching needed for a dual-standard colour receiver poses severe mechanical difficulties. The real trouble is not so much the amount of switching needed, for it is surprisingly little, but in the many different parts of the equipment where it is needed. The mechanical difficulties arise because the different switches must all be linked together for operation by one control.

Switches are needed between tuners, in the sound and vision i.f. amplifiers, in the video amplifier, in the line timebase and in the convergence circuits, where most con-

trols must be duplicated. The switches tend to occur physically in places where they are very awkward to link together and where it is almost impossible to do so using standard components. Provision for dual-standard operation is, of course, a commercial necessity and it is relatively easy to do under commercial conditions where special parts and linkages can be fabricated.

In any case, it does seem rather wasteful to use a colour tube for monochrome pictures. An expensive tube is having its useful life wasted when a black-and-white picture could be produced at least as well, if not better, by an ordinary tube.

### Transistors

So far nothing has been said about transistors. They are in fact used in considerable numbers in the i.f. amplifiers, the early video stages and the chrominance circuits. Valves are used, however, in the timebases and the final luminance and chrominance stages. It is possible to use transistors in all these places and at least one commercial receiver does so. One of the main practical difficulties lies in the fact that a colour tube is subject to occasional internal flash-overs which do no harm to the tube but which can easily kill any transistor connected to it. If transistors are used, therefore, it is necessary to adopt a great many protective devices. At the present time it is simpler to use valves which themselves buffer the earlier transistor stages.

The fact that valves are used does entail one disadvantage. The available valves have heaters designed for series connection and this means that the chassis is necessarily live to the mains. It is hardly practicable to build an isolating transformer into the receiver. The live-chassis receiver is, of course, safe enough when it is enclosed in a cabinet and

it is quite normal in commercial practice. If it is not so enclosed, however, and it can hardly be enclosed when fault-finding, it is potentially dangerous. This, of course, is nothing to do with colour. It applies to all mains equipment which does not include an isolating transformer and that is probably the majority of commercial equipment.

However, in the interests of safety the constructor is very strongly advised to use an external 1:1 ratio isolating transformer external to the receiver when working on it. If there are any earthed objects in the vicinity this must be regarded as an essential safety precaution, and it must not be forgotten that an electric soldering iron may very well be an earthed object in the vicinity! If for any reason a transformer cannot be used make quite sure that the chassis is joined to the neutral side of the mains, that there are no earthed objects within reach and that the mains plug of the receiver is completely withdrawn from its socket before using a soldering iron.

Before concluding this first general article, it may be well to give a little more detailed picture of the form of circuitry employed. The tuner itself is a commercial product and it feeds the i.f. amplifier through a short length of coaxial cable in the usual way. The i.f. amplifier has three stages with transistors, using stagger-tuned single circuits as inter-stage couplings and wave traps to provide the necessary out-of-band attenuation.

The vision carrier is placed at 39.5MHz and the sound carrier at 33.5MHz. Those accustomed to 405-line television must remember that standards are different with the 625-line system. Negative modulation is used on the vision carrier which means that the tips of the sync pulses correspond to peak carrier power. Frequency modulation is used on the sound carrier, and this permits the use of what is often called 'inter-carrier sound'. With this a common i.f. amplifier is used for vision and sound, but in it the sound carrier is attenuated by about 26dB relative to the vision carrier.

In the vision transmission the amplitude is never allowed to fall below some 5 per cent of its maximum; this occurs during colour bar waveforms. By attenuating the sound carrier by 26dB one ensures that it is always weaker than the vision signal; and, in fact, it must be attenuated more than this.

At the vision detector the vision carrier acts, in effect, as a local oscillator to heterodyne the sound carrier and produce a frequency-modulated sound signal at the difference frequency of 6MHz. This is picked out from the vision detector and passed to a 6-MHz amplifier which has two transistor stages and a ratio detector.

The video signal from the detector is fed to a transistor phase-splitter of about unity gain. The video signal is taken in one phase from the collector to feed the video amplifier proper, and in the other phase from the emitter to feed the chrominance circuits and also a two-stage d.c. amplifier which provides automatic gain control to the i.f. amplifier and the tuner.

The first stage of the video amplifier proper is another transistor phase splitter. Its emitter circuit contains a low-resistance potentiometer for contrast control from which the video signal is taken to the grid of

the video output valve. The sync separator is fed from its collector.

Substantially the whole of the video gain is provided by the valve output stage, the valve being of a special high- $g_m$  type. The anode is directly coupled to the tube cathodes, d.c. restoration being effected in the grid circuit.

The bandwidth of the video amplifier approaches 5MHz. The chrominance circuits, which we shall not discuss here, have a much narrower bandwidth. Because of this the time of transit of a signal through the chrominance circuits is about  $0.6\mu$  sec greater than through the video circuits. If something were not done about this the colour on the picture would be displaced sideways from the picture detail. What is done is to include in the video amplifier a delay line to equalize the transit times of a signal through the two paths. This is quite a separate and distinct thing from the PAL delay line, which is used in the chrominance circuits for an entirely different purpose.

As stated above, the video or luminance output stage feeds the tube cathodes. This is with the luminance or Y signal. The chrominance circuits conclude with three valve output stages which feed the three grids of the tube with R-Y, G-Y and B-Y signals, so that with Y on the cathodes, the grid-to-cathode signals become R, G and B.

When first setting up the equipment, the chrominance circuits are omitted and the three grids of the tube are then returned temporarily to a common fixed potential, so that the tube is fed with the Y signal only at its cathodes. The picture is then monochrome.

The field timebase is fairly conventional and has two valves. One is the output pentode and the other is a triode, the two forming a multivibrator type of sawtooth generator, which is locked by the field sync pulses in the usual way. Outputs are taken from the pentode cathode and from a winding on the output transformer to the convergence circuits.

The line output stage is also basically conventional. It is driven, however, by a LC oscillator running at line frequency which is kept at the correct frequency by the output of a phase detector which compares the line sync pulses with pulses from the line output stage. This is, of course, flywheel sync. While this is usually considered desirable when the signal is subject to interference, it is not usually necessary in areas of high field strength. In this case, however, it is necessary, and for a rather interesting reason.

A timebase which is directly locked by sync pulses is normally set to run at a basically lower frequency so that it can be tripped by the sync pulses line by line before it would trip of its own accord. This means that if the sync pulses fail for any reason, for instance if the transmitter breaks down, the timebase continues in operation at a frequency lower than the proper one. This normally causes no harm, but in this case it results in the anode dissipation of the line output valve becoming excessive. At the lower frequency the interval between successive flybacks is greater and the current has time to build up to a greater value.

Flywheel sync is needed to prevent this, for the free-running frequency with it is very close indeed to the locked frequency.

# Space Communication and Travel

Arthur Clarke, who proposed the concept of synchronous communication satellites in his article "Extra-terrestrial Relays" published in *Wireless World* in October 1945, collaborated with Stanley Kubrick, the film director, to produce "2001—a space Odyssey" which had its gala premiere at the Casino Cinerama Theatre, London, on May 1st. This spectacular space travel film centres around a megalomaniac talking computer which takes over an inter-planetary expedition with disastrous results. The film is both technically interesting and photographically breathtaking as one travels through a galaxy of colours into "space".

Several months ago Mr. Clarke addressed the British Interplanetary Society on "Voices from the Sky—the past, present and future of communication satellites". This paper, which was reproduced in the March issue of the Society's journal *Spaceflight*, made reference

to his prophetic *Wireless World* article. Commenting on the article he said "I must confess I . . . thought in terms of manned space stations, because in 1945 there was no alternative in the available technology. It was a good day on our unit [R.A.F.] if only one tube blew in the day's operations. The idea that you could have complex electronic equipment, without hoards of servicemen and spare parts to replace the burnt out components then seemed almost as fantastic as space travel itself. As far as I can remember the immediate reaction to the appearance of the *Wireless World* article was precisely zero".

The copper plaque reproduced below was recently presented to Mr. Clarke by Dr. Anthony Michaelis, science correspondent of the *Daily Telegraph*. Among the signatures are those of H. F. Smith and F. L. Devereux (respectively, Editor and editorial assistant of *W.W.* in 1945).

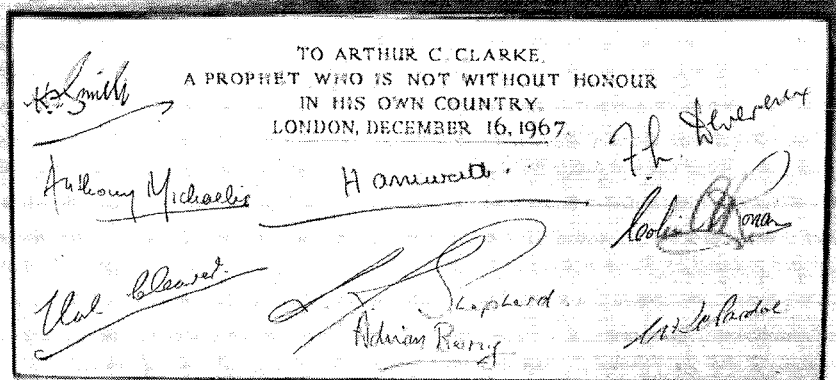
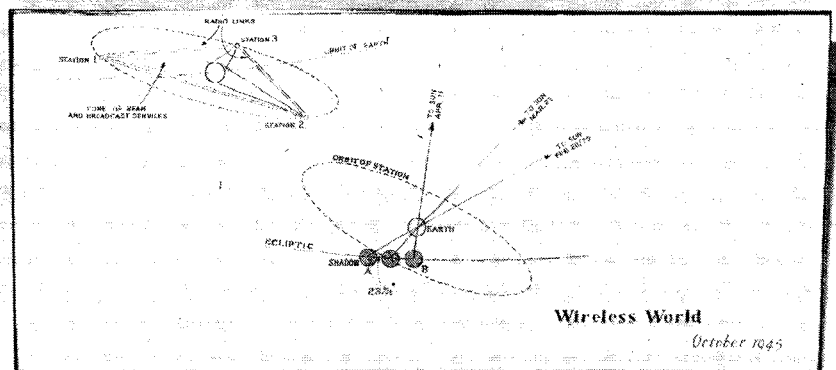

# Loudness Control for a Stereo System

## Circuit for automatic balance and tone compensation at all listening levels

by R. T. Lovelock, C.Eng., F.I.E.E.

It is customary to control the volume of a reproduction system by varying the gain of the audio amplifier while the signal is still at a low level. The standard method of doing this is to apply the signal across the track of a variable resistor, and to tap-off the desired fraction of it between a slider and the low-potential end of the track. In a practical system it is desirable to have an adequate range of controllable variation so that all tastes may be met, and all classes of music catered for. On the other hand it is equally desirable that the range shall not be too great, otherwise a sufficiently precise setting of the level cannot be obtained. A good range for which to design a system is 40 dB.

Very early in the development of electronic reproducing systems it was found that a linear variable resistance was not adequate for the purpose because the ear has a logarithmic response, and the majority of the desired range was crowded into the initial 10% of the rotation. To obviate this trouble the carbon-track resistor with a pseudo-logarithmic law was produced. The required response is approximated by constructing two nearly linear portions of track, of differing slopes, joined at an overlap by a deep curve. Although the response is far from the true logarithmic law and due to variation of the location of the curve joining the two end portions no two resistors have exactly the same law, every resistor gives a

satisfactory spread of voltage levels for the purpose of gain-control. One difficult problem in stereo systems is that of ganging two gain controls together. To cater for differences in the overall gain of the two amplifiers a balance control is provided but once having balanced the system at an intermediate output level, it is desirable that it remains balanced at all other usable outputs. This can only occur if the two gain controls ganged together have a very similar law. Unless the system does remain balanced it will be necessary, for good stereo effect, that the balance control be carefully adjusted at each re-adjustment of the output level, and this is an exasperation for the expert, and an insufferable nuisance for all others.

The root of the problem lies in the fact that no two log-law carbon-track resistors have nearly identical laws, and if they are ganged together their outputs will not remain in balance over more than a very limited portion of their usable range. A linear-law resistor would remain much more closely balanced but unfortunately it would not cover an adequate range of gain. The commercial items which the constructor is normally able to purchase are manufactured and supplied to a specification which defines the allowable departures from the theoretical law. Fig. 1 shows the extreme envelopes within which the resistance may fall for log carbon, linear carbon, and linear wire-wound

Fig. 1. Typical envelopes for the three types of variable resistor indicated.

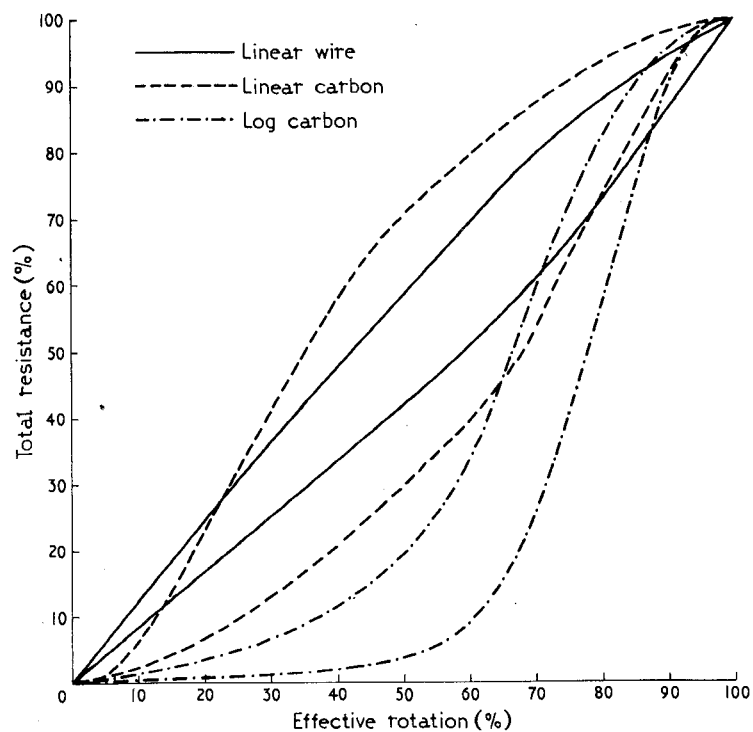
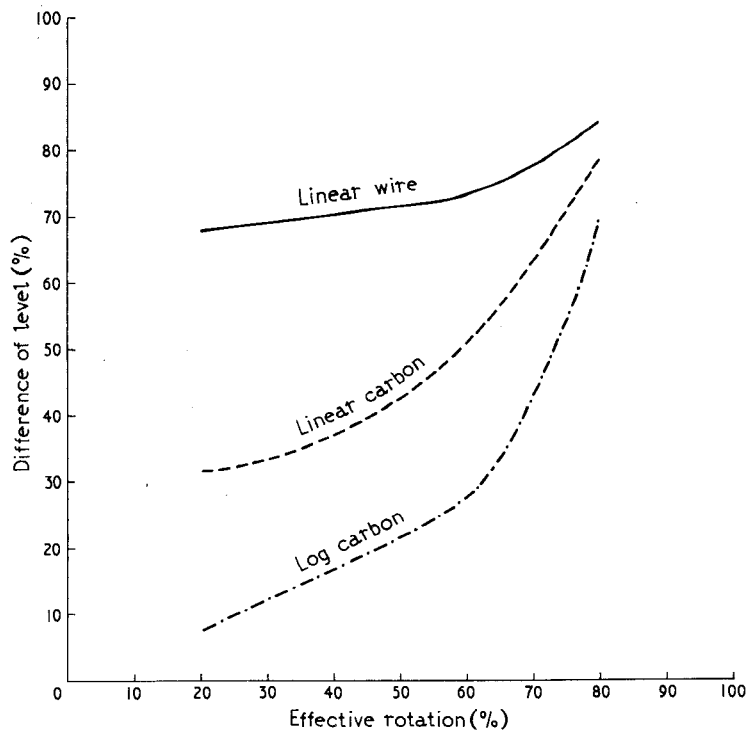

Fig. 2. Curves showing maximum difference between channels (lower channel as a percentage of higher channel).



types. It is very unlikely, of course, that any two resistors will differ by as much as this maximum permitted amount but it is equally unlikely that they will be very close to one another.

When these resistors are used in the conventional circuit for gain control and two of them are ganged together, it is possible to calculate the difference between levels in the two channels which may arise from this cause. Near the two ends there will be little difference, of course, and it is over the central portion of the range that they will differ most. On the other hand, it is this central portion which is most used in practice and which is representative of the performance to be expected. Fig. 2 plots the extreme difference which may be obtained over the central portion of the range, the lower channel being expressed as a percentage of the higher one. Again it is emphasized that it is very unlikely that this maximum difference will ever be experienced but a large difference will be met sufficiently frequently to make it a serious problem. It is evident from this figure that if a linear law is used to avoid the great differences in the log law, then a wire-wound resistor will be very much better than a carbon one.

In an endeavour to gain the advantages of closer matching in wire-wound variable resistors, an attempt was made to develop a circuit which would give a range of gain approximately linear over 40 dB using a single variable resistor in each channel. It was obvious that to attain this end it would be necessary that the resistor controlled the gain by two independent means simultaneously, and this was achieved by causing it to attenuate the signal directly, and also to reduce the gain of the stage by increasing the degree of negative feedback. A schematic of the circuit employed is shown in Fig. 3. The variable resistor has its slider connected to earth thus dividing the track into two separate resistors, each variable in value and connected to earth. One of these portions forms the lower arm of a signal attenuating circuit, while the other forms an impedance in the emitter circuit resulting in negative feedback in the amplifier.

In Fig. 4 the overall variation of gain with rotation of the control is plotted for a nominal law which is linear from zero to 1k  $\Omega$ . The departure of this law from the ideal linear characteristic, linear over a range of 40 dB, is also plotted. The ideal law is followed so closely that no apparent departure from it is evident when operating the equipment. In Fig. 5 is shown the maximum possible difference of levels between the two channels when a maximum possible difference exists between the two resistors. This is seen to be less than 5 dB for the worst case and is likely to be no more than 2.5 dB for all practical cases. For comparison, the departure between two channels for a log-law carbon resistor is shown for the same maximum difference between resistors. This reveals that the normal circuit using ganged carbon controls can have an error which is 5 times greater than that given by the linear circuit.

It is well known that the sensitivity of the ear does not vary in a linear manner over the whole of the frequency range. The

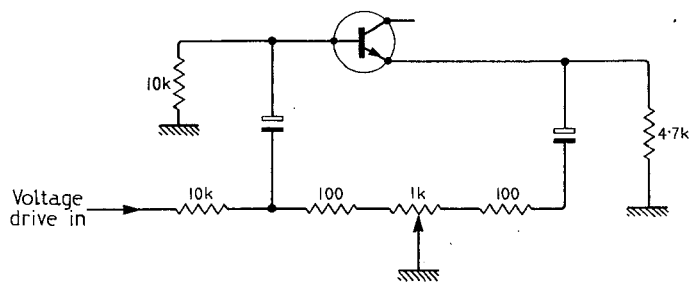

Fig. 3. Schematic diagram of the gain control circuit.

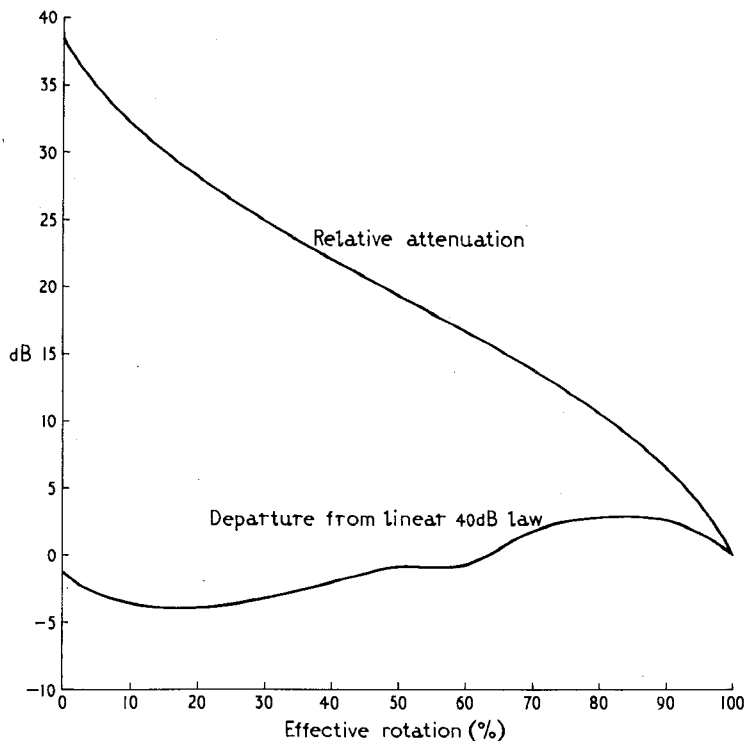
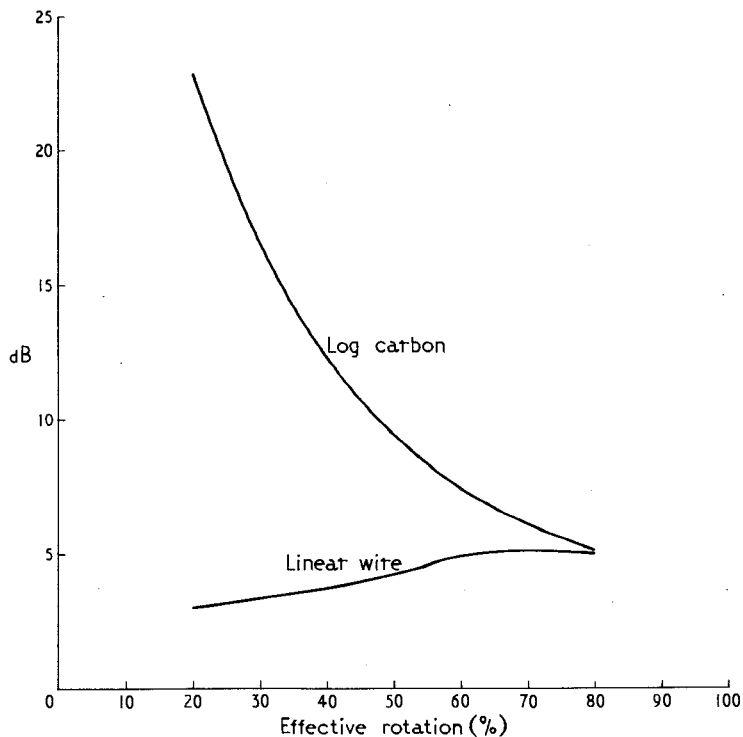
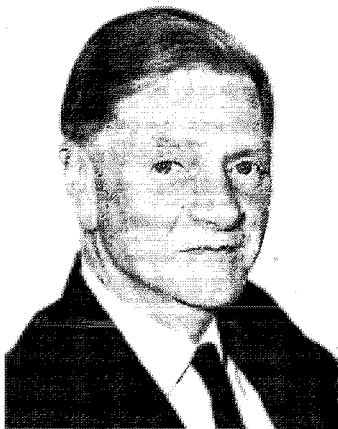

Fig. 4. Curves showing the overall gain/attenuator characteristic.

Fig. 5. Difference of level between channels for maximum spread of variable resistors.



*R. T. Lovelock has been technical director of Belling & Lee Ltd., since 1965. During his career on electronics circuit design he has been involved in work connected with the British Common Standard system since the inception of the second Burghard Committee, and has also been a U.K. delegate to the International Electro-technical Commission Committee meetings on environmental testing for a number of years.*



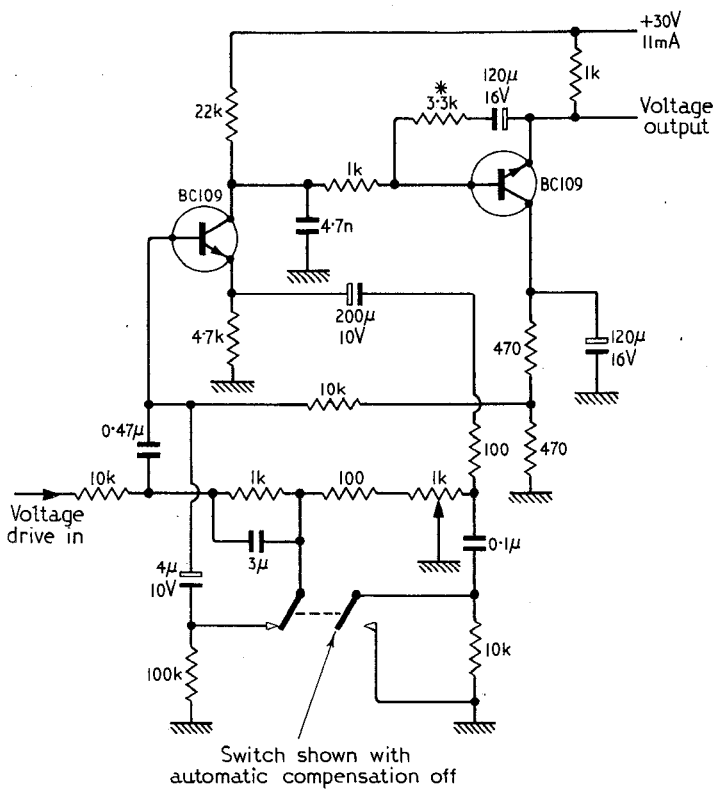

Fig. 6. Circuit diagram of the loudness control. The 3.3kΩ resistor marked \* is replaced in the amplifier by a tone control network with an effective resistance of 3.3kΩ at 1kHz.

difference in levels between the threshold of audibility and that of pain is much less at very low and very high frequencies than it is in the middle of the audio spectrum. If the frequency response is adjusted to sound correct when the reproduction level is high, it will sound thin and attenuated when the level is turned down to a soft effect. Since some people desire a high level, while others cannot endure it, if the response is maintained constant while the level is altered, the reproduction will be correct at only one of the many preferred levels. If quality is to be maintained at all levels it will be necessary to readjust the tone controls for each setting of the gain control. This is a requirement which is as inadmissible for all but skilled users, as would be the need to readjust the balance control, and in the interests of simple operation it is desirable that operation of the gain control should automatically vary the frequency response of the amplifier so that the optimum condition is maintained. Fortunately, the ear is not excessively critical, and it is possible

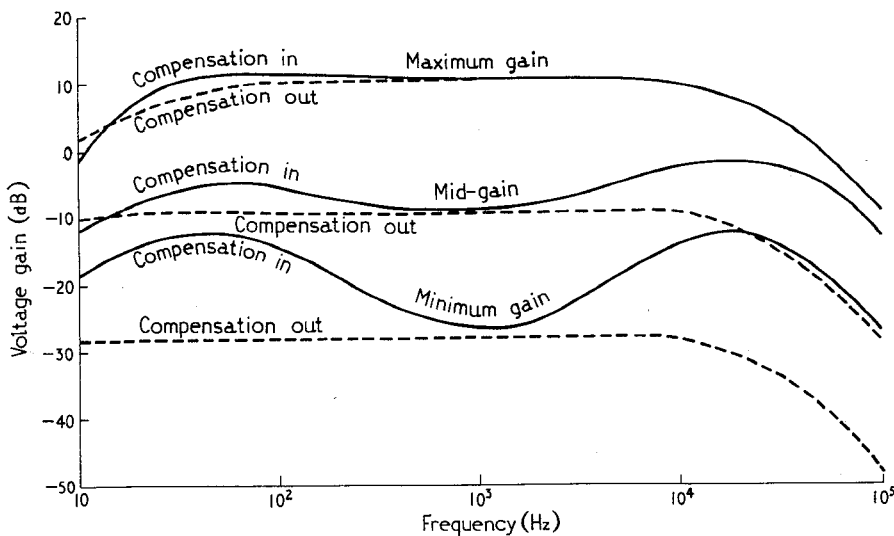

Fig. 7. Gain characteristics of loudness control.

to design a simple circuit that will be sufficiently approximate to the optimum condition, to be acceptable over the whole of the 40 dB range.

This circuit is shown in Fig. 6. Included is a switch which will allow the automatic correction to be cut-out, leaving the response constant with adjustment of the gain. If this switch is not required, then the additional two resistors and one capacitor associated with it can also be omitted. Two stages of amplification are shown, but the second is not needed if only the gain control is required; in the amplifier from which this circuit was taken, the 3,300Ω resistor was replaced by a tone-control network by which means the overall frequency response could be adjusted. As the gain is reduced, both low and high frequencies are reduced less than the central band. The 3μF capacitor boosts the low frequencies by increasing the impedance of the lower arm of the attenuator with decreasing frequency. The 0.1μF capacitor boosts the high frequencies by decreasing the impedance of the negative feedback network with increasing frequency. The maximum value of bass-boost is limited by the 1,000Ω resistor shunting the capacitor, and the maximum value of treble-boost by the 100Ω resistor in series with the other capacitor. The undesired bass-boost given at maximum gain is offset by two other corrections; by attenuation due to the 0.47μF capacitor, and by increase of impedance in the 200μF feedback capacitor which limits amplification at frequencies lower than 10 Hz.

The frequency response of the system at the extreme positions of the control, and also in the middle position, is shown in Fig. 7. The full line is the response with the automatic correction operating, and the dotted line is that with it switched out. The fall in gain above 20 kHz is given by the 4.7 nF capacitor, and contributes to the stability of the system. The fall below 20 Hz is of assistance in the removal of transient surges and of rumble; this would be assisted, of course, by the inclusion of a rumble-filter, but it is a wise precaution to back-up such a filter with a falling response in each separate section of the amplifier. If the tone-control of the amplifier is adjusted for acceptable quality at the mid-position of the gain-control, the response will be acceptable to the ear over the whole range of the control. To achieve this end it will be necessary that all inputs to the amplifier have a magnitude which gives maximum amplifier output at maximum gain control setting. In the amplifier from which this circuit was taken, each input channel was fitted with an individual preset attenuator to allow this condition to be obtained.

**Wire-wound variable resistors.**—Variable resistors normally available through retail channels are the commercial equivalents of models which in slightly different form meet the requirements of a military specification. Although they are not specifically sold to this specification, because so many of the parts used are common to both models, the resistance law will be approximately the same. The military specifications currently applicable are DEF 5122 for composition type, and DEF 5121A for wire-wound type. The laws and limits assumed in the article are derived from these two specifications, from the preceding RCS series, and from drafts now under discussion in the International Electro-technical Committee and in the British Common Standard. The resistors used were Colvern pattern CLR, chosen for their small size, approximately one inch diameter. The use of a larger type would have given very slightly better performance.



# Colour TV Development Continues in Europe

## Techniques described at Paris colloquium

Although Europe now has several colour television broadcasting services in operation, and the technology and hardware are beginning to look much the same wherever you go, colour television as a subject for research and development is by no means dead. A few years back there was great technical excitement over the systems battle. That field is certainly pretty well closed, but there is still much to be done in the improvement of electro-optical devices and information processing equipment within the framework of the established systems. Some idea of what fields are being considered worthwhile exploring could be gathered from the *Colloque International sur la Télévision en Couleur* held in the UNESCO building in Paris from 25th to 29th March. Over three hundred delegates and contributors from all over the world attended this conference, including a sizeable group from the communist-bloc European countries. (Details of Russian colour television sets, presented by Professor S. Novakovsky of the U.S.S.R., were published in the May issue, p. 113).

**Display devices.** The single-beam colour c.r.t. still holds a good deal of promise as a competitor to the shadow-mask tube, although a great deal of early research seems to have sunk without trace. Philips Research Laboratories, Eindhoven, consider the beam index version a worthwhile project and M. Lubben and P. M. v.d. Avoort described some aspects of their work on this device. As is well known, the beam index tube has a single electron beam scanning a tri-colour screen made up of vertical stripes of red, green and blue phosphors separated by black 'guard' stripes. In the Philips version all these stripes are 0.2mm wide and there are 400 RGB triplets across the width of a 23-inch tube. When the beam (spot size 0.4mm x 2.4mm) is activating a particular colour phosphor stripe it must be modulated with the colour signal, *R*, *G*, or *B*, appropriate to that stripe, so the tube includes an 'indexing' system to give

information on the position of the beam. This uses an associated stripe pattern on the screen: deposited over every other black guard stripe is an additional phosphor stripe which emits ultra-violet radiation when energized by the beam. This u.v. energy is picked up by a photomultiplier mounted on the outside of the tube envelope, and the output from this—the 'index' signal—indicates the position of the beam and is used for sequentially selecting the *R*, *G*, *B* colour signals.

A block diagram of the selecting system is shown in Fig. 1. The index signal from the photomultiplier is first filtered and limited to remove frequency and amplitude components due to the video modulation of the beam. It is then frequency-divided by 1.5 to make it equal to the triplet scanning frequency needed for switching in each of the colour signals. (The two frequencies cannot initially be made the same, by using one index stripe per colour triplet, because crosstalk would occur and cause phasing problem.) The output of the frequency divider, of angular frequency  $\omega$ , is then fed into a phase splitter which produces two carrier frequencies displaced in phase,  $\sin(\omega t - 21^\circ)$  and  $\cos(\omega t - 19^\circ)$ . On these are suppressed-carrier-modulated the *R* - *Y* and *B* - *Y* signals from the colour receiver. The two modulator outputs are then added to produce a chrominance signal, *C*. This is added to a monochrome signal, *M*, which is obtained from the luminance signal *Y* and a colour-difference signal *M* - *Y* (derived from matrixing *R* - *Y*, and *B* - *Y*). In the absence of colour information, say on a monochrome transmission, *R* - *Y*, *B* - *Y* and *C* are zero, and *M* = *Y*.

The final signal applied as modulation to the grid of the beam index tube is the equivalent of three band-limited amplitude-modulated pulse trains in t.d.m., one giving *R* samples, one *G* samples and the third *B* samples, and it contains a d.c. component, the monochrome information, plus an a.c. component,

*Fig. 1. Circuitry necessary for operation of the beam index single-beam colour c.r.t. The photomultiplier provides information on the position of the beam which is used for switching the colour signals.*

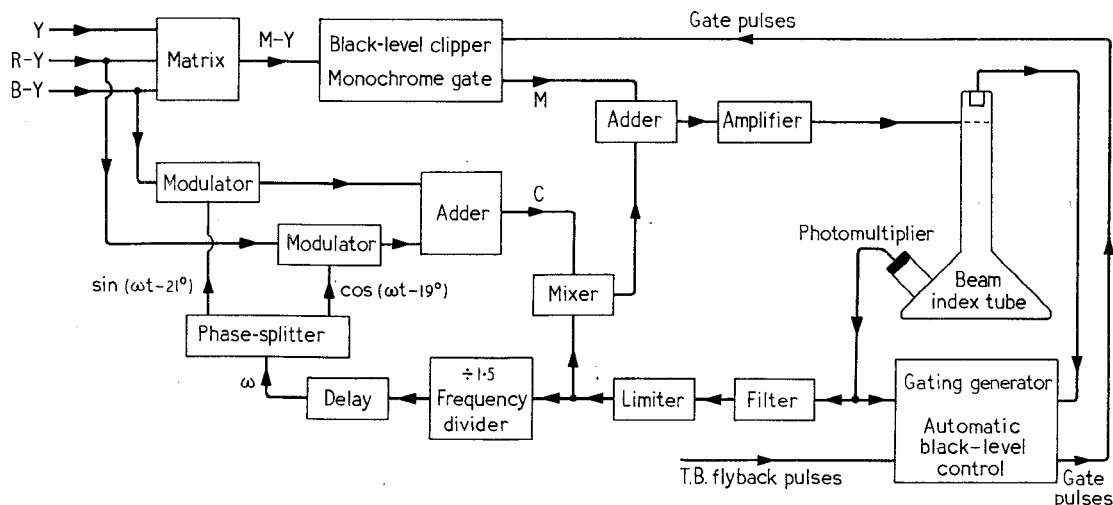

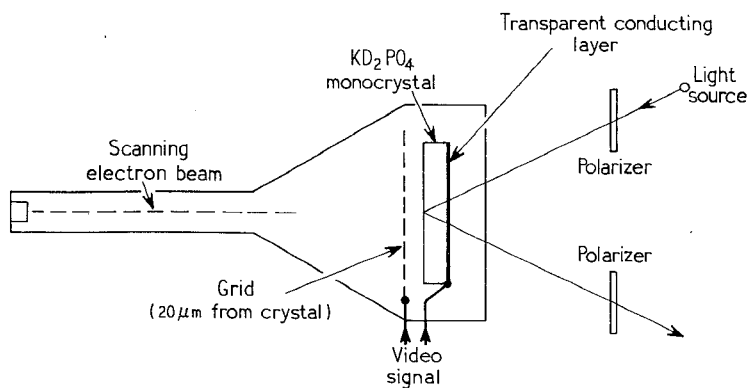

Fig. 2. Principle of operation of light-valve tube for projection television using the Pockels effect.

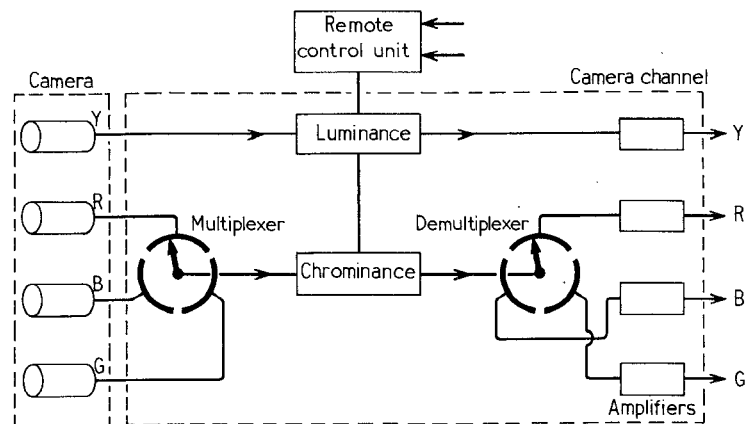

Fig. 3. Time-division multiplexing scheme in colour camera channel, allowing R, G and B signals to pass through a common processing unit.

the sequential R, G, B information. The stripe phosphor efficiencies are adjusted so that equal beam current for R, G and B results in a white screen: thus when a monochrome signal is transmitted only the d.c. component is present, and this produces intensity-modulated white; but when colour information is transmitted in addition, the presence of the a.c. component causes this equal-energization balance to be changed so that colour is produced on the screen.

Many of the operations in Fig. 1 are performed digitally, so that, although the circuitry is complex, the number of components required can be reduced by the use of integrated circuits. The main problems with the tube at present seem to be that the vertical stripe pattern is more visible than the dot pattern in a shadow-mask tube (although this can be mitigated by a lenticular screen placed in front of the tube); the saturation of primary colours is slightly lower than the correct value; and there are small errors of hue. But the big fundamental advantages of this single-beam tube—no mask or grid required, lower e.h.t. than the shadow-mask tube for a given brightness, no convergence system needed, no colour or grey-scale tracking problems—must provide a big incentive for continued development of the device.

A tube for projection television, performing a function similar to that of the Eidophor system but using a different physical principle, was described by G. Marie of Laboratoire d'Electronique et de Physique Appliquée (France). It modulates the intensity of light from an external source and can be used either for monochrome picture projection or, in a group of three tubes with an optical colour separation system, for colour television projection. The physical principle used is the Pockels effect, which is similar to the Kerr effect but taking place in a solid instead of a liquid. When certain crystalline materials

are subjected to an electric field they cease to be optically isotropic and the refractive index of the material becomes dependent on the direction of propagation and plane of polarization of the light passing through it. The plane of polarization of the transmitted light can be altered by changing the applied electric field and so, by inserting polarizers in the incident and emergent light beams, it becomes possible to modulate the intensity of the light by varying the voltage producing the electric field.

How this principle is applied in the L.E.P. tube is shown in Fig. 2. A beam of polarized light is directed at a monocrystal of  $KD_2PO_4$  mounted inside the evacuated envelope of the tube, and is returned from a reflecting surface on the rear of the crystal, finally passing through a second polarizer. The polarizers are crossed so that when the electric field applied to the crystal is zero no light is transmitted through the system. The video signal voltage is applied between a transparent conducting layer on the front face of the crystal and a grid spaced about  $20\mu m$  behind the crystal. This structure is scanned by a constant-current electron beam in the normal television manner, and at each point where it impinges on the crystal the beam forms almost a short-circuit between the crystal and the grid. If this point on the crystal is at a potential lower than that of the grid, the crystal loses electrons by secondary emission and its potential tends to rise. Conversely if the crystal potential is higher than that of the grid, the electrons cannot escape and the potential tends to fall. An equilibrium condition is reached, leaving the point on the crystal a few volts more positive than the grid. When the video signal is applied, at each point "touched" by the electron beam the grid-crystal capacitance at that point becomes charged to the voltage of the signal at the corresponding instant. There is consequently an electric field at this point and the Pockels effect occurs. Thus the light transmitted through the system is spatially modulated according to the pattern of electric field "cells" written by the electron beam.

The device is constructed in the form of a 3-inch image orthicon camera tube and uses conventional deflection and focusing coils. Examples of projection pictures it produces were shown. Definition and contrast were described as "satisfactory".

M. T. Inamiya described a Japanese portable colour receiver, intended for the American market, which has been designed around a 12-inch shadow-mask tube developed by Toshiba. This rectangular tube is 35cm long, has a  $90^\circ$  deflection angle and weighs 3.6kg (8lb). The electron guns are smaller than normal (8mm in diameter) but the tube neck diameter is standard—36.5mm. Unipotential focusing is used in the guns. Average anode current is  $400\mu A$ . The shadow mask contains 117,000 holes of 0.24mm diameter, with a pitch of 0.65mm. Phosphor dots on the screen are 0.41mm in diameter and have a pitch of 0.67mm. The faceplate glass is tinted, giving 65% light transmission.

**Cameras.** A miniature Plumbicon pick-up tube with a diameter of 1.6cm—half that of a standard Plumbicon—has been developed by Philips Research Laboratories. At the colloquium its possibilities were strikingly demonstrated by a Philips man who produced a portable colour television camera, using three of the tubes, which was comparable in size and weight with a 16mm film camera without lenses. Despite the small size, the definition is said to be "not much different" from that of a large camera, while sensitivity is "comparable". The camera itself weighs 3kg, while an associated electronics unit connected to it weighs 4kg. Applications in television news broadcasting and closed-circuit systems are envisaged. The miniature tube, which is 13cm long, has an image diagonal of 10.5mm and uses a modified version of the photoconductive layer of the standard Plumbicon. The mesh screen behind the layer—part of the anode—has an extremely fine structure of 1500 meshes per inch.

Focusing is electrostatic. Tube definition is given as a modulation depth of 40% at 3MHz with a maximum "white" signal current of  $0.2\mu\text{A}$ .

An interesting innovation in a four-tube Plumbicon camera recently introduced by C.S.F. (France), and described by R. Cahen, was the use of a single electronic processing unit in the camera channel for all three colour-tube signals, red, green and blue. Normally cameras have a separate processing unit for each of these signals, but where the signals undergo simultaneous non-linear operations (e.g. gamma correction) in these units it is difficult to avoid discrepancies between them and there is consequently a danger of colorimetric distortions occurring. In the C.S.F. camera this problem is averted by multiplexing the separate *R*, *G* and *B* signals into a composite signal which then passes through the single processing unit so that all three colour components receive identical treatment. The combining and eventual separation of the *R*, *G* and *B* signals is done by time division multiplexing, as shown in Fig. 3. Each colour signal is sampled at a p.r.f. of 5MHz, and the three pulse trains, each carrying its colour information by pulse amplitude modulation, are displaced in phase relative to each other and combined so that the resulting composite signal has a p.r.f. of 15MHz. This then passes through the processing unit and is finally de-multiplexed by a reverse operation to recover the separate *R*, *G* and *B* signals.

**Home video recording.** A technique designed to allow colour television signals to be satisfactorily recorded by and played back from domestic video tape recorders was outlined by M. F. Koubek of the Technical University of Vienna. Present domestic v.t.r.s can cope with monochrome signals but cannot handle signals including a colour subcarrier (at, say, 6MHz) because of their restricted bandwidth—typically about 2MHz. Shifting the colour subcarrier for recording purposes down to about 1.5MHz would, of course, result in a very visible dot pattern on the picture. Koubek's solution is to encode the narrow-band colour information—actually three colour difference signals—on a line sequential basis, à la SECAM, to produce a chrominance signal which is combined with a luminance signal at the lower end of the video frequency band. The sum of the three colour-difference signals is zero, so the average value of the chrominance signal is zero, and consequently the composite signal, to be recorded and played back, is compatible. Since the chrominance information is at the lower end of the video band, the composite colour signal is not seriously impaired by bandwidth limitations in the recording equipment.

Fig. 4 shows the principle of the encoding system. The *R*, *G* and *B* input signals, obtained from a receiver, are transformed by matrixing into a *Y* (luminance) signal, a colour difference signal  $U = 0.19(B - Y)$  and a colour-difference signal  $V = 0.51(R - Y)$ . The third colour difference signal,  $W = (G - Y)$ , is obtained from the other two, by addition and polarity inversion, in order to ensure that  $U + V + W = 0$ . Thus, while hue and

Fig. 4. Encoding scheme for producing a narrow band composite colour signal suitable for home video recorders.

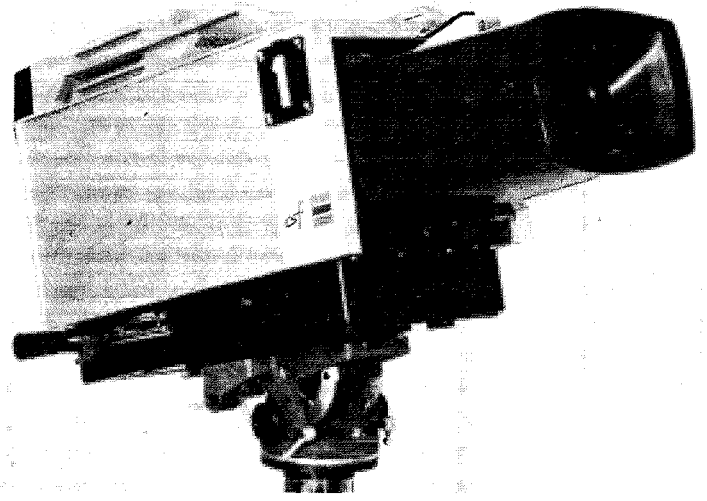
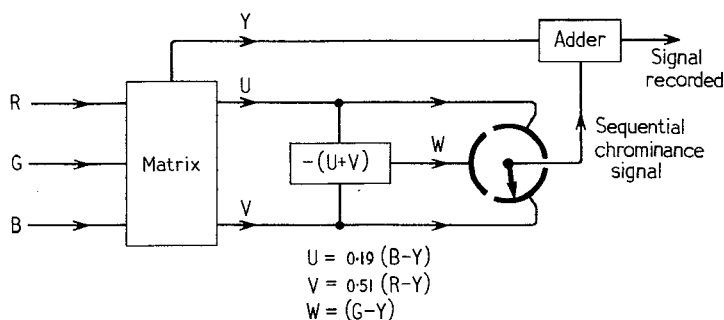

New C.S.F. four-tube Plumbicon colour camera utilizing the multiplexing principle shown in Fig. 3.

saturation are conveyed by *U* and *V*, the signal *W* makes the system compatible. The three colour-difference signals are then selected in turn, on a line sequential basis, and added to the *Y* information to form the final composite signal. Koubek explained that the frequency spectrum of the chrominance signal does not contain frequency components at multiples of the line scanning frequency, so that the chrominance spectrum can be frequency intercalated with the luminance spectrum. The decoding equipment, for recovering the *R*, *G* and *B* signals from the played-back information, utilizes two delay lines. Apart from domestic recording, Koubek suggested that the technique could also be used for narrow-band industrial television systems.

## June conferences and Exhibitions

Further details are obtainable from the addresses in parentheses

### LONDON

- June 5 & 6 Northern Polytechnic  
**Space Communications**  
 (Dept. of Electronic & Communications Engg, Northern Polytechnic, London N.7)
- June 10-14 Savoy Pl.  
**Industrial Measurement Techniques for on-line Computers**  
 (I.E.E., Savoy Pl., London W.C.2)
- June 27 & 28 Imperial College  
**Better Management Through Standards**  
 (B.S.I., 2 Park St., London W.1)

### OVERSEAS

- June 3-8 Stresa  
**Electromagnetic Wave Theory**  
 (Int'l Scientific Radio Union, 7 Pl. Emile Danco, Brussels 18)
- June 10-14 Copenhagen  
**British Engineering Exhibition**  
 (S. Black, London Chamber of Commerce, 69 Cannon St., London E.C.4)
- June 12-14 Philadelphia  
**Communications Conference**  
 (I.E.E.E., 345 E. 47th St., New York, N.Y. 10017)
- June 17-19 St. Louis  
**Microelectronics Symposium**  
 (I.E.E.E., 345 E. 47th St., New York, N.Y. 10017)
- June 20-22 Cleveland  
**Optimal Systems Planning**  
 (Prof. T. J. Williams, Laboratory for Applied Industrial Control, Purdue University, Lafayette, Indiana 47907)
- June 23-26 New York  
**Impact of Microelectronics**  
 (Electronic Industries Assoc., 2001 Eye St., N.W., Washington, D.C. 20006)

# Output Transistor Protection in A.F. Amplifiers

## A description of protection methods, outlining their limitations, and a practical circuit providing a linear load-line characteristic

by Arthur R. Bailey,\* M.Sc.(Eng.), Ph.D., M.I.E.E.

THE sensitivity of transistors to overload has been one of the major factors restricting their use in power amplifiers. Indeed many amplifiers have warnings stating that damage can result from accidental short-circuit of the output connections. In fact, failure of the output transistors may be due to one of two major causes, and it is important to distinguish between them.

The most obvious cause of failure is due to overheating by excessive collector dissipation. This usually occurs in class B output stages, when the collector dissipation can rise to excessive values if the load is accidentally short-circuited.

In class A operation, the collector dissipation in a transistor amplifier is the same under quiescent conditions as when driving into a short-circuit load. If severe overdrive occurs, the stages normally back-bias automatically and limit the output current to a safe value.

Unfortunately class A operation necessitates very large heat sinks to absorb the high continuous power dissipation of the output transistors. To reduce this dissipation to more reasonable proportions the so-called pi-mode

method of operation has been used.<sup>1</sup> In this case the output transistors operate in pure class A for small input signals but progressively back-bias with increased signal. Ultimately full sine-wave drive causes the operating point to be that of pure class B. The quiescent class A current is approximately the same as the mean current under class B conditions so the mean transistor current is approximately constant. This therefore protects the transistors from overload so far as mean dissipation is concerned as overload has little effect on the mean transistor current. Unfortunately the dissipation in the transistors is still quite high and there is also the possibility of the circuit biasing back into class C for full drive on waveforms other than pure sine-wave.

Class B is the obvious choice so far as dissipation is concerned and nearly all commercial amplifiers run in or near to pure class B operation. Unfortunately in class B there is no protection of mean transistor dissipation by the biasing circuits and the system is wide-open to catastrophic failure.

ally assists in their protection. Unfortunately the mean output current is then higher than the normal full sine-wave drive value and the transistors may fail due to excessive dissipation if the overload is prolonged. Backing-up fuses are therefore desirable to prevent breakdown on prolonged faults. Basic circuits for mean and peak overcurrent protection are shown in Figs. 1 and 2. It should be noted that there are really two classes of operation under the heading of "mean protection", mean d.c. supply current being true mean protection, whereas fuses are really r.m.s. protection. They have however been grouped together as in neither case is there any attempt to limit the peak transistor current on overloads.

It might be expected that peak current protection with backing-up mean protection would be sufficient for any power transistor. Unfortunately this is not so, and the reason cannot be found in mean collector dissipation. There is, therefore, a second effect tending to cause failure and this is the phenomenon known as secondary breakdown.

\*University of Bradford

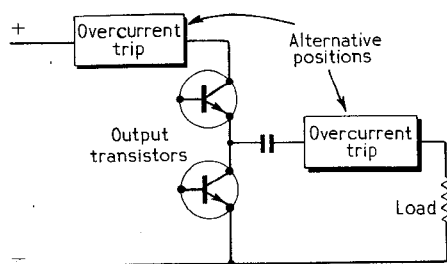
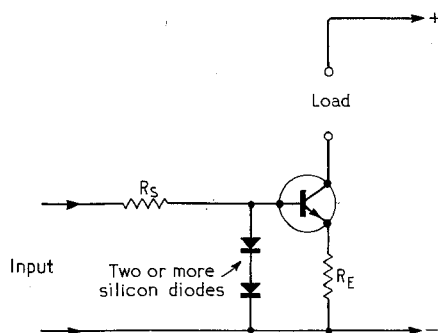

Fig. 1. Normal positions for mean overcurrent protection devices.

Fig. 2. Peak overcurrent protection using diverting diodes.



### Mean overcurrent protection

The most commonly used protection system is that of circuit disconnection if the mean output current exceeds the correct full-drive value. Such disconnection can be in the power-supply, output transistor circuits or the output lead of the amplifier. The mode of operation may be a fuse, thermal trip, electronic trip or other device. Such protection may be satisfactory if the power transistors have a large reserve of dissipation, but for many transistors the mode of operation is too slow and the output transistors may fail before the protection operates. Even if failure does not take place, the transistor junctions may have been damaged and the device may therefore fail at a later date. Such protection is therefore inherently unsafe.

### Peak overcurrent protection

This is less common than the previous type, but it has been used commercially by Grundig and also by the author.<sup>2</sup> In this mode of protection, diodes are used to prevent the peak output current exceeding a pre-determined safe value. This prevents high peak currents flowing in the output transistors, and materi-

### Secondary-breakdown in power transistors

In transistors having a considerable junction area mean collector dissipation is no longer a complete guide to safety. It is possible to have different parts of the wafer at differing temperatures forming local "hot-spots". Also at high working voltages the effective base-width of the transistor is reduced by "Early-effect".<sup>3</sup> This increases the non-uniformity of current distribution across the transistor wafer; such irregularities occurring naturally due to imperfections in base width and doping levels, etc. The non-uniform current distribution tends to generate local hot-spots and the localized heating increases the current gain and the tendency to avalanche breakdown at these points. The increased localized current gain increases the current density in the hot-spots and thermal runaway may ensue giving failure at the hot-spot. This localized thermal avalanche breakdown can occur at mean power levels far below the power that the transistor can dissipate at low values of collector voltage.

Curves of Safe Operating Area Ratings (SOAR) are therefore given for many output transistors, the worst case for breakdown being at d.c. and low frequencies. This is

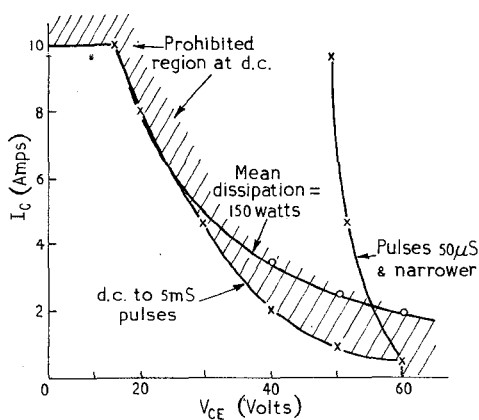

Fig. 3. Safe operating areas and maximum dissipation line for typical output transistor (2N 3791).

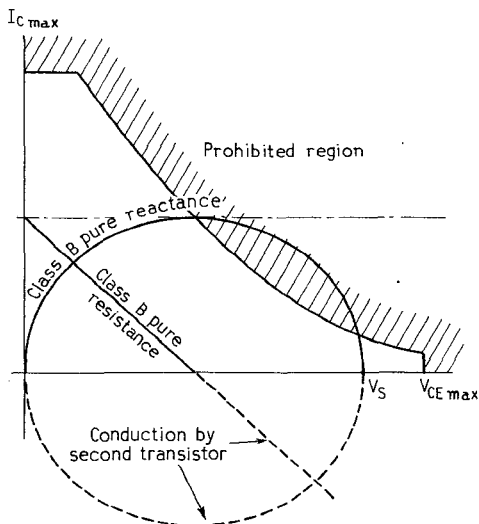

Fig. 4. Resistive and reactive load-lines for class B output stage showing breakdown risk with pure reactive load.

because short pulses do not give the hot-spots time to establish fully, and the consequence is that failure is more likely in low frequency operation. Audio-frequency amplifiers come within the worst area of operation so it is essential that output transistors are kept within the worst SOAR characteristic. Typical values are shown in Fig. 3. It will be seen that the maximum allowable d.c. dissipation at high collector voltages is far less than the normally quoted "maximum dissipation". Fixed current-limit transistor protection will therefore be unable to protect adequately under reactive load conditions, where large currents may be drawn at the time when the collector voltage is a maximum.

### Reactive load conditions

Under resistive load conditions in a class B stage conduction takes place when the transistor collector is above half the rail-to-rail voltage. Secondary breakdown is therefore extremely unlikely. Reactive loads however draw maximum current when the voltage across the transistor is a maximum and this is the worst case for secondary breakdown. Unfortunately all loudspeakers and most laboratory dummy loads are not resistive and therefore an amplifier may test safely on a

resistive load but blow-up on a loudspeaker. Anyone doubting the reactive properties of loudspeakers should consult Briggs' book on loudspeakers<sup>4</sup> where some very alarming degrees of load reactance are shown with normal types of loudspeaker.

Fig. 4 shows the operation load lines for one half of a class B output stage under conditions of equal load impedance; in one case pure resistive and the other pure reactive. The conduction at high collector voltages is very apparent in the reactive load case and could obviously cause failure. For foolproof protection it is therefore essential to limit the operation of the output transistors to within the d.c. safe operating area, irrespective of the load impedance presented to the amplifier.

### Load-line protection

Plain overcurrent limiting has shown to be inadequate at high values of collector voltage, so some method of reducing the limiting current value at high voltages must be used for complete protection. Ideally the limit to output current would be along the limiting line of the SOAR characteristic, but unfortunately this is normally non-linear. In practice, however, a straight line will enable sufficient output power to be developed; this limiting load-line is shown in Fig. 5. Provided that a circuit will limit the output transistor current to this load-line, then there is no possibility of transistor failure due to overload.

The simplest way of attaining such protection is to use a transistor as a shunt across the drive to the output transistors. If the base of this transistor is fed with voltage signals proportional to both output transistor voltages and current, then the transistor will start to conduct at a point which follows a linear load line. A suitable circuit<sup>5</sup> is shown in Fig. 6. The emitter-base conduction voltage of approximately 0.6 volt (for a silicon transistor) determines the point where protection starts. The base of the protection transistor is driven nearer to conduction by either increased collector current or collector voltage of the output transistor. The current sensing is done by utilizing the voltage drop across the emitter resistor of the output transistor, this being proportional to the emitter current (and therefore approximately collector current) of the output transistor. By a suitable choice of component values the protection line can be arranged to be of any desired slope. To prevent the driver stage overdriving into the protection transistor, a current limiting resistor may be required in the feed to the base of the output transistor.

### Practical protection circuits

It must be understood that no universal values can be given that will protect all amplifiers, owing to the widely differing voltage and current levels involved. It is possible however to calculate the ends of the limiting load-line as follows:—

$$I_{max} = \frac{0.6 (R_2 + R_3)}{R_2 R_e}$$

$$V_{max} = \frac{0.6 (R_2 + R_3) R_1}{R_2 R_3}$$

Assuming the value for  $R_e$  that is given for the amplifier design and using a value of 47 ohms for  $R_3$ , then the value of  $R_2$  can be evaluated knowing the maximum allowable d.c. collector current. Inserting the value of  $V_{max}$  then enables the value of  $R_1$  to be determined.

Often the SOAR ratings are not known, and then one has to resort to a certain degree of guesswork. To allow for driving into fairly reactive loads  $I_{max}$  must be greater than the peak current output into a resistive load—say 50% greater.  $I_{max}$  is therefore approximately:

$$I_{max} \approx 2.25 \sqrt{\frac{\text{output power}}{\text{load resistance}}} \text{ amperes}$$

e.g. 2.25 amperes with an amplifier rated for 16 watts output into 16 ohms load. Equally  $V_{max}$  can be allowed to be about 20% greater than the rail-to-rail h.t. voltage (e.g. 60 volts for a 50-volt h.t. rail difference). These values appear to be quite safe in practice and no failures have been obtained.

In the circuit design described by the author<sup>2</sup> this method of protection can be applied instead of the current limiting diodes originally specified. A suitable circuit is shown in Fig. 7. This operates very satisfactorily and is certainly safer than the original protection which has not always protected on gross overload.

Under conditions of full drive into short-circuit or reactive loads the transistor dissipation will be high. The value will be greater

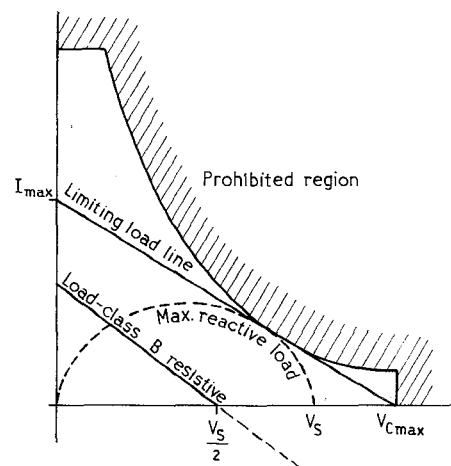
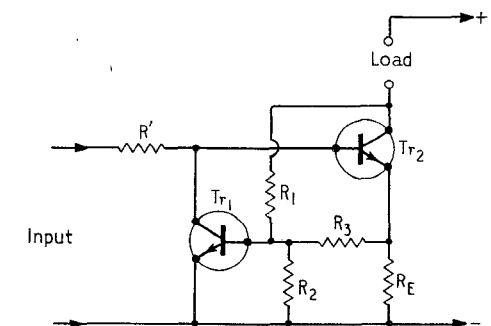

Fig. 5. Use of linear limiting load line to give safe operation.

Fig. 6. Linear load-line protection circuit using clamping transistor across input.



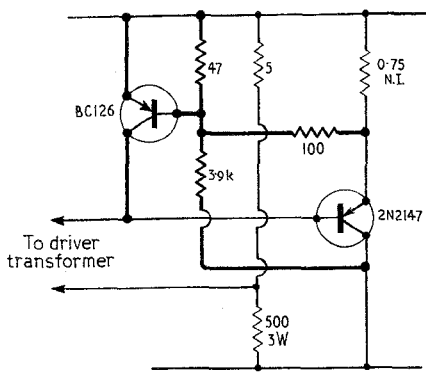
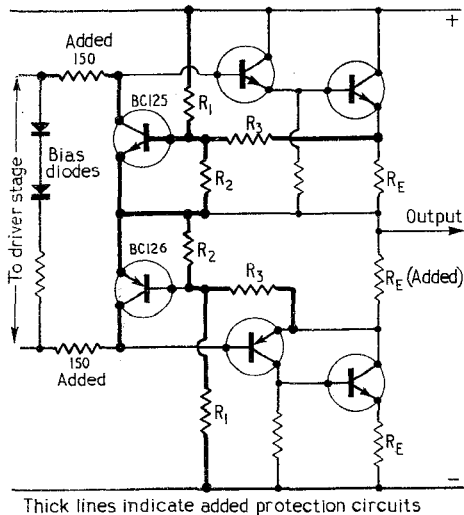

Fig. 7. Practical protection circuit for transformer-driven amplifier. Thick lines indicate added components.

Fig. 8. Load-line protection for quasi-complementary output stage.



than the maximum obtained with sine-wave drive into resistive load, so the heat-sink area must be adequate if continuous drive into short-circuits is envisaged. This dissipation will depend on the values of current and voltage limit used, but will normally be about 12 watts for each output transistor in a nominal 16-watt amplifier. Heat-sink size is therefore dependent on the duration of any possible overload. For normal service there does not appear to be the need to cater for such sustained overloads, but laboratory amplifiers will obviously need this reserve.

All the tests conducted by the author have shown the protection to be absolutely safe, even though sparks can be drawn by shorting the amplifier output! The system will operate up to very high frequencies if planar transistors are used for clamping the drive. Equally very sharp spikes fed to the amplifier are limited safely without any breakthrough. The circuit therefore appears to afford the complete solution to output transistor protection.

For complementary and quasi-complementary output stages it is necessary to use complementary clamping transistors. These are readily obtained at reasonable cost and can be used to protect the driver transistors as well as the power transistors. A suitable circuit arrangement is shown in Fig. 8. This has been used very successfully by the author.

In conclusion the author would like to acknowledge the use of the facilities of the University of Bradford where much of the testing was done. Thanks are also due to Mr. Arthur Radford for his encouragement and his many transistors sacrificed in the search for an adequate system of protection.

#### References.

1. R. Osborne and P. Tharma "Transistor High-quality Amplifiers" *Wireless World*, June 1963 Vol. 69 No. 6. pp.300-304.
2. A. R. Bailey "High-performance Transistor Amplifier" *Wireless World*, November 1966, Vol. 72 No. 11. pp.542-546.
3. M. J. Morant "Introduction to Semi-conductor Devices" (Harrap 1964) p.92
4. G. A. Briggs "Loudspeakers" Fifth Edition, (Wharfedale Wireless Works) pp.78-85.
5. S. G. S. Fairchild Ltd., Design Note 16—20 Watt High-Fidelity Amplifier using Silicon Planar Transistors. June 1966.

## Interference and Microwave Systems

The congestion of the frequency spectrum presents an ever increasing problem to the microwave transmission engineer because of the risks of interference. Such interference may be within a single system, or between differing systems and, in this respect, interference between terrestrial line-of-sight systems, and between terrestrial and satellite systems warrants particular attention because of the ever increasing need for communication capacity. For example, the current Intelsat satellites receive transmissions radiated by earth stations, in the 5925-6425-MHz band, and re-radiate the transmissions in the 3700-4200-MHz band. However both these bands are allocated on a shared basis to terrestrial services and are already extensively used throughout the world. This means that there is a considerable risk that terrestrial systems, in the 4-GHz band, may (if their aerials are pointing towards the satellite) cause interference to the satellite. Similarly, earth stations radiating several kilowatts of power in the 6-GHz band may well interfere with nearby 6-GHz terrestrial systems. A conference was held in London at the I.E.E., on April 23rd and 24th, to discuss some of these problems.

In many cases it is possible to optimize aerial design in order to reduce interference, and the first session of the conference was devoted to these designs. A paper by Dr. M. S. Afifi (Technological University of Delft) discussed the problems of scattering from microwave aerials, particularly in relation to a design employing a paraboloid and a plane reflector. Although the superior sidelobe performance of such "folded" types has been accepted for some time, the cost would probably be prohibitive when applied to a satellite earth station. G.F.S. Swann and M. Flack (G.P.O.) reported the results of measurements, made with the Goonhilly aerial, on two transmitters at 167 and 230

km distance. In each case the aerial was tracked over a square grid and locii of percentage of time, for which a specified signal level was exceeded, were plotted. There was marked evidence of reflections from a 1000-ft television mast some 1.2° off the direct bearing.

Two papers by A. E. Baker (G.P.O.) discussed the problems of planning terrestrial radio relay systems so as to avoid interference from within, and outside, the system. Potential sources of interference within the system include the effects of local oscillator harmonics, feeder mismatches and image and adjacent channel crosstalk. Again, extensive re-use of the same frequency is aided by good aerial discrimination.

The Intelsat II and III satellites employ the multi-destination carrier principle, i.e. a transmitting station assembles a composite baseband, consisting of channels for a number of destinations; each of the distant stations receives this composite baseband and selects those channels that are destined for it. This arrangement presents a number of frequency planning problems, since it is often difficult to select a frequency which is acceptable to all those who have to receive it (because of the risk of local interference from other terrestrial systems sharing the same band). The procedure adopted for the Intelsat system was described by J. B. Potts and J. F. Arnaud, of COMSAT.

Interference between satellite systems is possible should two satellites lie within the beamwidth of the earth station aerial. This fact will ultimately place a limit on the number of satellites that can be usefully placed in the synchronous orbit, and this subject was discussed in a paper by J. K. S. Jowett, of the G.P.O. It was shown that from 2-4 satellites could be placed in a 10° arc, of the synchronous orbit, and that these could carry some 10,000-20,000 circuits.

A factor of considerable importance to the multichannel telephony systems engineer is the relation between wanted to unwanted r.f. carrier ratio, and the interference level produced in a telephone channel. This is frequently called the "interference reduction transfer factor", and an analysis of the factor for interference to, and from, wideband and narrowband f.m. and s.s.b. systems, was given by P. B. Johns (University of Nottingham).

A session was devoted to the siting of earth stations. In the U.S., for example, where there are some 5,000 and 2,500 terrestrial radio-relay systems already operating in the 4 and 6-GHz bands respectively, co-ordination raises considerable problems. The difficulties of siting military stations, which may have to operate in close proximity to h.f. stations, radars and other navigational aids, were described by representatives of H.Q. Signals Command, R.A.F. A paper by D. E. Cridlan (G.P.O.) described the results of measurements on the spurious outputs of radar systems. Those employing magnetrons can be particularly troublesome as many of the unwanted products bear no harmonic relation to the fundamental frequency.

In general, it was apparent that microwave system planners are fully aware of the potential risks of interference, but one wonders whether some of the system designs have not, perhaps, too many built-in safety factors.

# News of the Month

## B.O.A.C. Flight Booking System

It would appear incredible an airline could consider that spending £42M on an automated flight booking system was an economically viable undertaking. B.O.A.C. obviously do as it is costing them this to have BOADICEA (British Overseas Airways Digital Information Computer for Electronic Automation) installed. This computer complex will link all major B.O.A.C. flight reservation centres in North America and Europe with a central computer terminal at Heathrow Airport London.

Three I.B.M. computers in London will communicate over voice quality telephone lines with Ferranti Argus 400 computers at the main flight booking terminals. Each Argus, in turn, will drive a number of Ferranti c.r.t. display systems and provide the computing capacity necessary for the keyboards associated with these displays and for organizing the information into blocks for transmission to the central computer.

In use, a booking clerk interrogates the system using the keyboards, perhaps in answer to a customer's enquiry for a flight between two points on a given day. Within three seconds the c.r.t. will show details of all suitable flights and the number and types of seat available. When the customer selects a particular flight the clerk types in other details together with any special requirements (diet, etc.) the disc files of the central computer are updated and a flight booking confirmation is immediately sent off to the relevant display equipment. The computer operates in a "conversational mode" that is, it "asks" the clerk for the next piece of information; this greatly helps in any complicated multi-flight journey bookings.

At Heathrow "computer central", three I.B.M. computers are being installed with a comprehensive disc storage system of 1,400 million byte capacity (1 byte = 8 bits). The disc stores will hold details of B.O.A.C. flight schedules for almost a year in advance together with a record of the number of seats booked on each flight and other relevant information.

Information is exchanged between computer central and the Argus satellite computers at the rate of 2,400 bauds, corresponding to 400 characters or about seven messages, a second; it is expected that this will be increased to 4,800 bauds later.

The difference between this and other

flight booking systems that have been built in the past can be summed up in two words, speed and flexibility. The main parameters of the system are set entirely by the software, modifications being performed by a programme alteration. This policy is reflected right through to the keyboard/display units. All that these store in the way of characters are sixteen lines of different length at 52 different angles, therefore any drawing, shape of character can be built up from these lines as a programme on the Argus 400.

The flexibility is illustrated in the method used for training booking clerks. Here an Argus 400, driving a number of displays, has been programmed as a teaching machine. Booking clerks are presented with a series of typical booking situations and are asked to go through the correct procedure. In the event of a mistake being made the clerk is informed of his error by the Argus which will not proceed with the programme until the error has been corrected.

Incidentally, B.O.A.C. intend to extend the use of the system to flight planning, cargo control and other day-to-day problems sometime in the future.

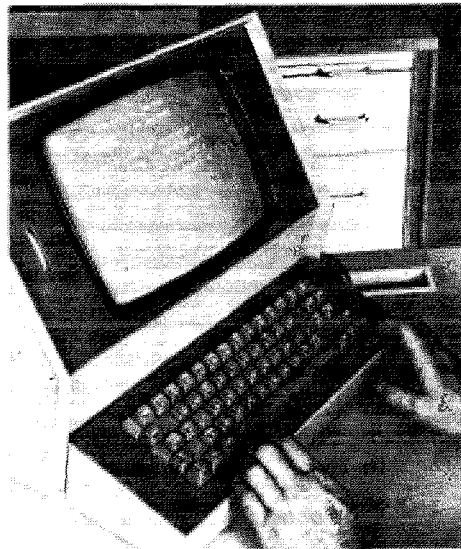

*A Ferranti c.r.t. display unit which has been installed as part of the terminal equipment for Boadicea. The equipment consists of some 30 Ferranti Argus 400 computers and 700 c.r.t. display units.*

## Applying "Bosworth" in Semiconductors

Starting in September in Southampton is the first course to be run by a newly formed training organization called the Semiconductor Technology Centre. Operated jointly by Southampton University and Associated Semiconductor Manufacturers Ltd., this centre is an attempt to put into practice the recommendations of the Bosworth Report\* on getting graduate engineers and scientists into industry. The Report said the most pressing problem was to devise some kind of effective "matching" between the output of university and the input of industry, and this is what the new centre hopes to provide. No actual building has been put up for the purpose but the 16-month M.Sc. course will use facilities provided by the University's Department of Electronics and by the Southampton factory of A.S.M. Ltd. (Joint directors of the project are Professor G. D. Sims, of the University, and Dr. E. A. O. Roberts, of A.S.M.) The industrial and university work done by the students will, however, be integrated at all stages: lectures will be given by people from both sides and the whole course will be under joint supervision. The organizers stress that it is not a sandwich course.

Financial support, to meet the capital and running costs of the scheme, is being provided by the Ministries of Technology and Labour, the Department of Education and Science (University Grants Committee and Science Research Council), the Engineering Industry Training Board, and the Conference of the Electronics Industry. Running expenditure will be recouped from the fees charged to students, which will be £1,800 per student (£500 at the University, £1,300 at A.S.M.). Most of the students will be graduates just about to be recruited into the semiconductor industry, and will be sponsored by the various firms who will be employing them. Technically, therefore, the fees will be paid by their employers (in addition to their salaries), but in practice the fees will be largely offset by a number of grants for which most students are expected to qualify (e.g., £500 from the S.R.C. to pay the University fee; a £500 Industrial Studentship grant and a £540 grant from the E.I.T.B.).

\*Under the chairmanship of Mr. G. S. Bosworth a Working Group set up to examine the education and training requirements of industry issued two reports: an introductory one, "A review of the scope and problems of scientific and technological manpower policy", H.M.S.O. Oct. 1965, and "Education and training requirements for the electrical and mechanical manufacturing industries", H.M.S.O. 1966.

## GAD—The Printed Transistor

Thick film circuits incorporating both passive and active thick film devices have become a distinct possibility. This fact emerged at the well attended joint I.E.R.E., I.E.E., conference on thick film technology held recently at Imperial College, London. In a paper prepared by G. A. Wilkin and R. J. Mytton of the International Research and Development Co. Ltd., and G. H. Elson of Rutherford College of Technology, work

being carried out at I.R.D. on thick film transistors was described.

In a similar project, being carried out at Texas Instruments, U.S.A., the acronym GAD (Graphic Active Device) was suggested as being suitable for transistors produced in this manner as the initials t.f.t. have already been reserved for thin film transistors. The aim of the I.R.D. project is to produce an insulated gate field effect transistor with a gain bandwidth product of 10MHz when operated in the enhancement mode.

The semiconductor material chosen for producing these devices must be capable of being formed into an organic based ink for screen printing on to a ceramic substrate. The screened layer, after firing, should yield a sintered polycrystalline layer with good semiconductor properties. Although the bulk material may possess such properties it does not follow that they will remain after the printing and firing process. At I.R.D. the substances being used are cadmium sulphide and associated chalcogenide materials.

Three approaches are being made to the problem of forming a suitable dielectric layer. The first of these entails printing a relatively thick dielectric layer using a normal ferro-electric ink. The second method consists of passing a mixture of silane and nitrogen over the semiconductor printed substrate at a temperature of 400°C forming a layer of silicate on the semiconductor surface. The third possibility is to form a layer of cadmium fluoride by treating the printed substrate with hydrofluoric acid.

The source and drain connections will probably be formed from a gold paste, the chief problem here being to form a short source-drain channel without any short circuits.

The material for the gate electrode is not critical the chief requirement being for accurate dimensions and close registration.

With the technology at its present state it would appear that devices having a transconductance of 0.5mA/V and a gain bandwidth

product of 1MHz could be produced, further development being needed to bring all the variables in the process under control.

## British Compact Computer Introduced

Dr. Jeremy Bray, Joint Parliamentary Secretary to the Ministry of Technology, opened the new Computer Technology factory on the industrial estate at Hemel Hempstead on May 1st. At the same time Computer Technology's first product, the computer Modular One, made its debut. Computer Technology was formed when a small group of computer engineers got together, under the leadership of I. M. Barron, and formed their own company. The project was supported financially in Britain by Technical Development Backers and on the Continent by European Enterprises Development; in addition there was also a number of private backers. It is surprising when the current trend is towards larger and larger computer firms that such a small organization managed to obtain this necessary backing in their attempt at going it alone. Executives of the Company say that because the computer industry relies on innovation rather than on research and that because a smaller company can have a faster response to new ideas they consider they have a definite advantage.

Modular One was designed for multi-access operation and to be competitive with American compact computers. With its smallest store, 8k bits, a central processor and a tele-typewriter it costs £13,000. It is built entirely using Motorola MECL 2 integrated circuits. In order to cut down costs multi-layer printed boards have been avoided and double-sided boards with printed through holes have been employed. Also, by careful design the need for interboard back wiring has been reduced to a minimum and is carried out on more double-sided printed boards or by flexible printed wiring that

results in reduced production costs and increased reliability.

Modular One has a store cycle time of 750ns, an addition time of 1.5µs, it will multiply in 2 to 3µs and divide in 3 to 4µs. Data is transferred at a rate of 22M bits/sec and an infinite number of programme interrupts can be accommodated. A sixteen bit word is used. Programmes are written in SYMBOL or FORTRAN and run under executive control with communication via the terminal. Any number of independent programmes can operate concurrently and the system changes context in 4µs on interrupt.

Extra storage units, peripheral and central processors can be added as desired to expand the machine. Each unit is supplied complete with individual power supply and integral interface unit so that expansion may be carried out with the minimum of trouble.

## Droitwich Frequency Stability

The signals from the B.B.C.'s 200kHz transmitter at Droitwich have long been used as a reference frequency standard. Since 1965 the long-term stability has been within  $\pm 5$  parts in  $10^{10}$  and with the use of automatic frequency correction the excursion from nominal has not exceeded 1 part in  $10^{10}$ .

The frequency stability has again been improved by using a rubidium gas cell standard provided by the National Physical Laboratory. This has a day-to-day stability better than 1 part in  $10^{11}$  and the frequency will be maintained within  $\pm 2$  parts in  $10^{11}$  of nominal referred to the caesium beam standard at N.P.L.

The phase of the received signal is monitored at N.P.L. and the value of mean daily frequency is available on application to The Director, National Physical Laboratory, Teddington, Middlesex.

## Yachtsman's Electronic Gadgets

One of the contenders in the third single-handed transatlantic race which starts from Plymouth on June 1 is a 49-year-old electronics engineer, Noel Bevan, of Hartley Wintney, Hants. His boat *Myth of Malham* is equipped with a number of home-made electronic aids one of the most interesting being an audible warning device, that rings a bell if the boat goes off course. Such a thing is not new but to produce it as cheaply as Bevan has—using neither of the established principles, i.e., concentrating the earth's magnetic flux in a soft iron bar or using a compass controlled device—is noteworthy. He made the device, which he calls an off-course indicator magnetic field sensor, for under £10 and it includes a unit which decides whether the swing off course is merely momentary before waking the skipper.

There is no engine aboard, and Noel Bevan has designed a device for charging his batteries by converting the heat from his pressurized paraffin heating stove to current, based on "back-to-front" connected Frigistors.

There are seven radio receivers in the

*One of the more complex configurations of Modular One. The desk arrangement houses a processor and three 8k store modules plus a high-speed tape reader. A high-speed tape punch and a second processor are at the rear.*

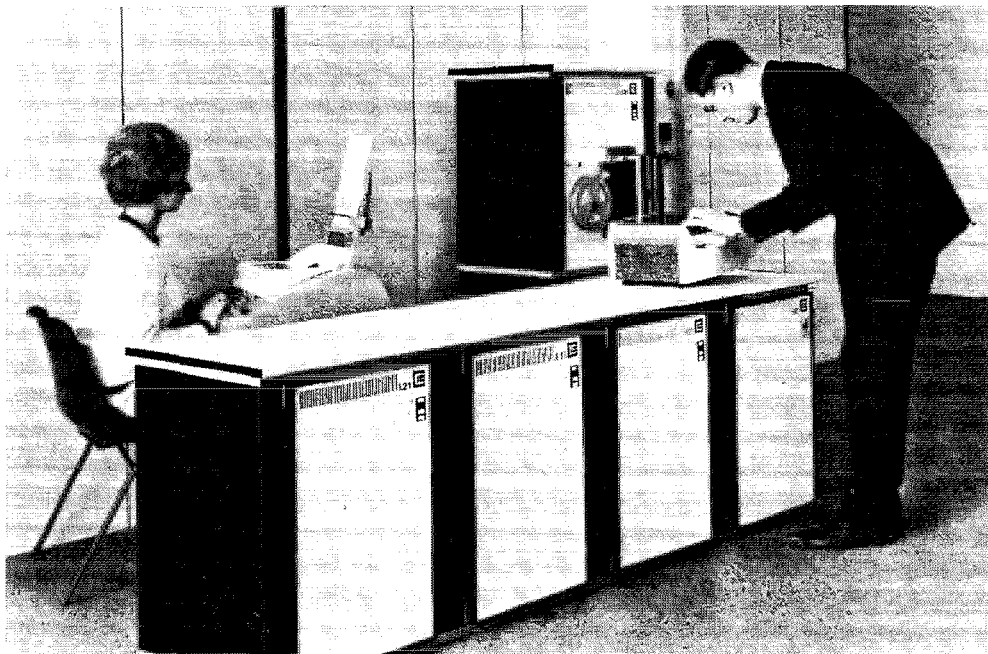



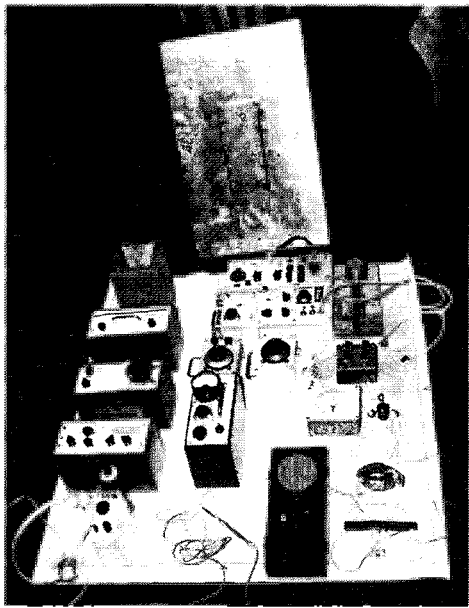

*Home-made equipment that will assist Noel Bevan in his bid to win the transatlantic yacht race. Top, thermo-electric battery charger. Left-hand column starting at top; directional radar receiver, omni-directional radar receiver with alarm, broadcast receiver, v.l.f. receiver, d.f. receiver. Other items shown are; communications receiver, electronic thermometer (water temperature), frequency standard, anemometer, and off-course indicator.*

boat. One gives audible warning if a ship carrying radar comes within 10 miles and another gives a bearing on that ship. The radar warning receiver uses a horn aerial and employs a reflex type circuit; when a signal is received the horn doubles as a "loud-speaker", the audio transducer being mounted in its base.

Another low-frequency receiver is for the reception of naval and other station broadcasts on weather conditions.

For iceberg warning, he has underwater acoustic apparatus similar to the sonar "ping" acoustic set-up in submarine chasers, only looking forward instead of downward. There are two quartz crystal chronometers, one homemade. *Wireless World* hopes to be able to give constructional details of some of these devices sometime after the race.

## New Zealand in Satellite Link

New Zealand will probably decide next month to open a satellite communications link with the world. The Post Office in Wellington has recommended a start on a satellite ground station and ancillary equipment rather than a second Trans-Tasman undersea cable. Grounds for the decision are that there will be a slight economic advantage. Australian telecommunications engineers visited Wellington about two months ago and discussed with the N.Z. Post Office officials, who had earlier despatched two of their own engineers to Britain to study satellite systems, the possibility of a satellite link. Three years ago New Zealand became a member of Intelsat and undertook a commitment to pay about \$A640,000 over four

years into the "club" without any immediate benefit. The move, however, safeguarded national interests in future satellite transmissions, and rights can be exercised at any time. It could be three or four years before satellite transmissions can be commercially exploited in N.Z. The link envisaged will be primarily for burgeoning telephone and telegraph traffic, although it will have a capacity for television, including colour television. So far the N.Z. television system lacks even a network hookup between its four channels. It has to be decided between the Post Office and the Broadcasting Corporation who will be responsible for the necessary local landline or microwave links, which would relay any satellite-borne programmes.

## Now its Plug-in to Expertise

We are all very familiar with the concept of building up complex systems with electronic building blocks, plugging in, or wiring in, modules to achieve our aims. The technique has spread into other fields; soon, if the educationalists have their way, we will be building up our knowledge by "reading in" clearly defined small blocks of knowledge and each budding specialist will receive his training from a selection of such standard educational modules. This became clear at a recent I.E.E.T.E. conference on modular education at Loughborough University of Technology.

Discussions at the first session ranged over the problems of the present course structure; was it satisfactory; is the present selection system good enough; how long should an educational module be and whether a single course structure could be provided for the wide spectrum of activity covered by technicians.

Later discussion hinged around the problems related to training engineers for particular branches of industry and as to whether a single formula could be produced, within the modular scheme, to cover all aspects of training, retraining and continuing training.

Two facts that emerged were that modular education had a vital part to play in the future and that educational establishments should concentrate on educating, and industry on training.

## Missile Defence Contract

The British Aircraft Corporation have won a £150M contract that entails supplying a mobile and flexible air defence system to the government of Libya. The system consists of Thunderbird and Rapier anti-aircraft missiles controlled by dual-purpose radars which, together with a comprehensive telecommunications system, provide early warning and tactical control for missiles and fighter aircraft. Sub-contractors to B.A.C. are Marconi, Elliott Automation, and Plessey Radar. They will be responsible for the radar, communication and computer controlled display equipments. Ferranti are involved in the production of Thunderbird, and Decca Radar, Barr and Stroud, and Cossor have an interest in Rapier.

The Royal Television Society invites applications for the 1968/69 **John Logie Baird Travelling Award**. This award, value £200,

is open to post-graduate students (in United Kingdom educational establishments) who are concerned with some scientific aspect or aspects of electronic engineering, television or allied technology. It is expected that the award will be made to someone in the age group of 21-30 years of age. The Award is intended to assist the successful applicant in undertaking a period of investigation abroad of approximately 6-8 weeks during 1968. During this period some aspect of electronic engineering, television or allied technology will be studied or surveyed. Application forms for the Award are available from the Royal Television Society at 166 Shaftesbury Avenue, London W.C.2. All applications must be submitted not later than 31st May.

The possibility of **low-priced television receivers** from Hong Kong competing in our already over-competitive market has now become a certainty. A company called Promotors Ltd., officially opened last November in Hong Kong, is now producing dual standard monochrome receivers with 9, 19 and 23 inch screens under the brand name Peacock with a target output of 1,500 receivers per month. The Company intends to exploit the estimated £1.5M Hong Kong home market and to export to other Asian countries before launching its assault on the American and U.K. markets. At the present time, in Hong Kong, the small nine-inch portable sells for £38 as against £58 for an equivalent Japanese model and the 23-inch dual standard set costs £68 compared with £82 for the Japanese equivalent.

"**Electronics in the 1970s**" is the title of an I.O.R.E. convention to be held at Cambridge University between July 2nd and 5th. The convention will consist of a number of whole and half-day symposia devoted to: computers and automation, electronic engineering education, automatic test equipment, communications and future materials and components. In addition, survey papers will be presented on lasers, underwater acoustics, high-power ultrasonics and oceanography. Registration forms are obtainable from the Conference Registrar, 8/9 Bedford Square, London W.C.1.

Users of **Mullard educational films** should note that a new distributor has been appointed—Educational Systems Ltd, ESC House, Imperial Drive, North Harrow, Middlesex, and that several new titles are available. These are: Principles of Magnetism, Colour Television and Semi-conductor Physics—a five part film. Educational establishments undertaking computer projects will be interested to know that Mullard are offering ferrite core stacks with a capacity of 4k words of 41 bits at reduced prices. The stores are surplus to requirements and are of obsolescent design, interested parties should contact Mr. N. F. Thompson, Mullard Ltd, New Road, Mitcham, Surrey.

In the article a **Sensitive F.E.T. Voltmeter**, by D. E. O'N. Waddington, published last month type TIS67 transistors were specified for  $Tr_1$  and  $Tr_2$ . This was in error, the type that should be employed is TIS68. Also, note that the wiper of  $S1_6$  should be connected to  $Tr_3$  collector.

# Personalities

**Douglas C. Birkinshaw**, M.B.E., M.A.(Hons.), F.I.E.E., who is retiring from the B.B.C. on June 7th, has been closely associated with British television since the B.B.C. launched the experimental transmissions using the Baird 30-line system from a studio in Broadcasting House in August 1932 when he was in charge of the project. In preparation for the start of a regular television service, Mr. Birkinshaw joined the team responsible for planning the Alexandra Palace station. He was appointed engineer-in-charge in March 1936, and supervised the start of the service in November of that year. During the war he was engineer-in-charge at Daventry. In 1945 Mr. Birkinshaw returned to Alexandra Palace as superintendent engineer, television, to supervise the engineering arrangements for the re-opening of the television service in June 1946. He relinquished his activities in television in 1963 on his appointment as general assistant to the Director of Engineering.

**G. T. Waters**, B.E., M.I.E.E., is appointed director of engineering of Radio Telefis Eireann, the Irish broadcasting organization. After graduating from University College, Dublin, in mechanical and electrical engineering, he spent a short time in the Department of Posts and Telegraphs before joining Radio Eireann as transmitters engineer in 1957. In 1961 he transferred to the television

G. T. Waters



service and in 1965 became manager of the Television Production Planning and Control Department. He has been head of production facilities since last August.

**J. M. Westhead**, B.A., Ph.D., until recently general manager of the Distribution Equipment Division of A.E.I. Cables Ltd., has joined Pye Telecommunications Ltd. as general manager with a seat on the board. Dr. Westhead studied at Oxford University and in 1950 graduated with first class honours in physics. Two years later, while a University demonstrator in electronics, he gained his doctorate in nuclear physics. In 1956 he joined B.T.H. which became part of A.E.I. C. A. **W. Harmer**, O.B.E., who has been acting managing director of Pye Telecommunications (now part of the Philips organization) has retired. Mr. Harmer has been a director of several of the Pye companies for some years.

**H. J. Jones**, B.Sc., production manager of the Plessey Components Group's Semiconductor Division at Swindon for the past five years, has been appointed works manager of the division and is now responsible for its overall administrative functioning, as well as for production. Mr. Jones joined the company 23 years ago at its Allen Clark Research Centre at Caswell. A chemistry graduate of Hull and London Universities. Mr. Jones, who is 38, is also a Fellow of the Chemical Society, and an Associate of the Royal Institute of Chemistry.

**Eric Tyler**, M.I.E.R.E., who began his industrial career with Decca in 1947 after demobilization from the Royal Navy and joined Plessey in 1965, has been appointed group commercial and marketing executive of Plessey Electronics Group. He became commercial manager of the Decca Navigator Company in 1948 and was at one time executive vice-president of Decca Radar in the United States. From 1961 to 1965 he was manager of the New Products Division of Decca Radar as well as international sales manager of the company.

**Jack Dinsdale**, B.A., M.I.E.E., well known to readers of *Wireless*

*World* for his amplifier designs, has joined the staff at the College of Aeronautics, Cranfield. He is a senior research engineer with the Industrial Unit in Precision Engineering and will be concerned with electronics, automation and data processing in relation to precision mechanical engineering. After graduating at Trinity College, Cambridge, in 1959 Mr. Dinsdale joined the Weapons Division of Elliott Brothers where he was latterly project leader in the Military Data Systems Division. Soon after joining Elliotts he did a year's post-graduate study on magnetic tape recording at the College of Aeronautics.

**D. E. Todd**, B.Sc., M.I.E.E., has succeeded **J. Redmond** as B.B.C. assistant director of engineering. (Mr. Redmond became director of engineering on the retirement of Sir Francis McLean.) Mr. Todd, who is 52, obtained his degree at London University and joined the B.B.C. in 1946 after eleven years on the development of high-power transmitters with Standard Telephones & Cables Ltd. Since joining the B.B.C., he has been concerned with the planning and installation of the Corporation's network of television and



D. E. Todd

radio transmitters, and since 1965 has been head of the Transmitter Planning & Installation Department.

**W. Peter Dean**, who went to the U.S.A. in 1959, has joined the Philco-Ford Corporation's Microelectronics Division as manager of the hybrid circuit department. Since being in America he has been with several semiconductor manufacturers and was, until joining Philco-Ford, product manager of hybrid integrated circuits with the National Semiconductor Corporation.

**Waldo Thorn**, M.I.E.E., has been appointed managing director of Celdis Ltd., Reading, Berks, in succession to **Clifford G. Bailey**, who is to devote himself fully to the activities of the parent company, Unitech Ltd. Mr. Thorn, aged 36, became general manager of International Rectifier Company (G.B.) in 1963 and a year later manager of International Rectifier Corporation

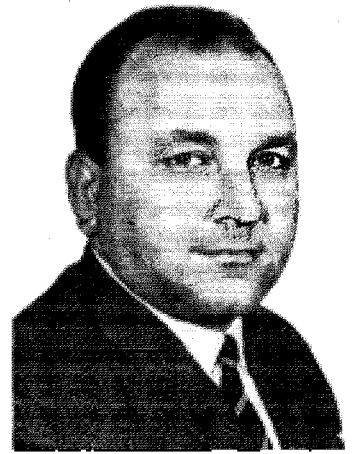

W. Thorn

Italiana SpA., Turin, Italy. He left International Rectifier in 1967 and returned to the U.K., and prior to joining Celdis, was responsible for setting up a new micro-joining equipment division in the K. & N. Electronics Group.

**George W. Tillett**, who contributes our bi-monthly "Letter from America", has been appointed executive vice-president of Audio Dynamics Corporation, New Milford, Connecticut. He joins Audio Dynamics from the Fisher Radio Corporation where he was director of engineering at their Pennsylvania plant. Prior to going to the U.S.A. he had been technical director of Wharfedale, and also chief engineer of Heathkit in Great Britain.

**Arthur C. Edwards** has retired from his post as commercial director of Eddystone Radio Ltd. A well-known amateur transmitter (G6XT), Mr. Edwards, who is 62, has been with Eddystone since 1927. He has been commercial director since his return from service in the Fleet Air Arm during the second World War. Eddystone has been a subsidiary of the Marconi Company since 1965.

**A. D. Horn**, who joined the Radar Division of the Marconi Company in 1952, has been appointed commercial manager. In 1954 he transferred to the Export Department and spent four years in Iraq as a representative of the Company. Since 1963 he has been manager of the Commercial Sales Division. Mr. Horn, who is 44, served in the Radar Branch of the Royal Navy after which he spent five years with B.O.A.C. and International Aeradio before joining Marconi.

Cable and Wireless Ltd., have announced the secondment of **E. P. Eades**, F.I.E.E., to the International System Management Division of COMSAT in Washington, D.C. Mr. Eades, who is 52, has been with Cable and Wireless since 1933. He has served at many overseas stations, was appointed manager in Singapore in 1964 and since April 1965 has been special representative, Far East, based in Hong Kong.

# MARCONI high performance 90' EARTH STATION

*Complete system service  
Modular construction  
Exceptional reliability*

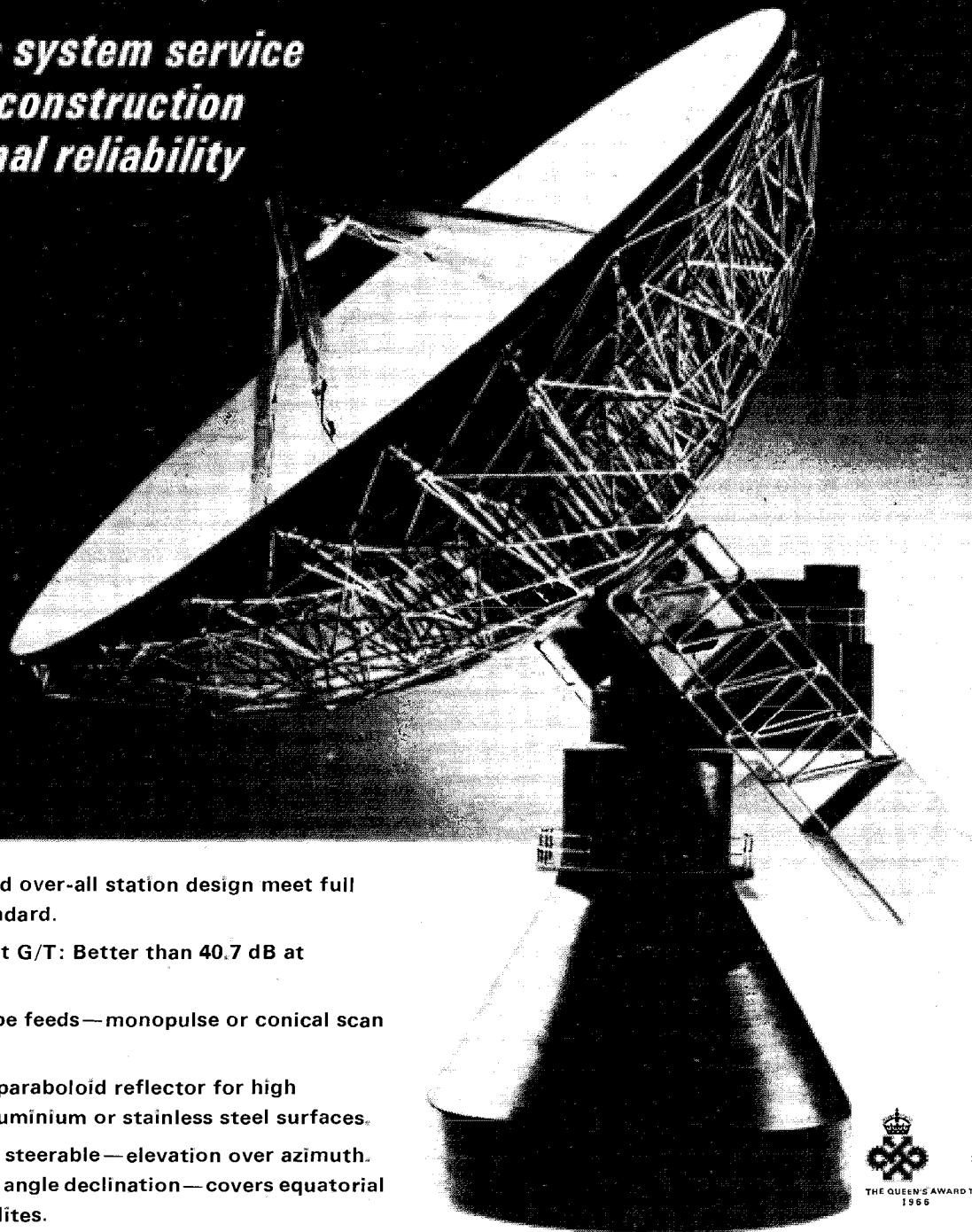

- Integration and over-all station design meet full INTELSAT standard.
- Figure of merit G/T: Better than 40.7 dB at 5° elevation.
- Cassegrain type feeds—monopulse or conical scan available.
- Unique quasi-paraboloid reflector for high efficiency—aluminium or stainless steel surfaces.
- Mounts: Fully steerable—elevation over azimuth. Hour angle declination—covers equatorial satellites.
- Transmitters: Either T.W.T or Klystron type—wide and narrow instantaneous bandwidth.
- Receivers: Helium-cooled parametric amplifier. Threshold demodulators.

## **Marconi—space communications systems**

The Marconi Company Limited,  
Space Communications Division, Chelmsford, Essex

AN 'ENGLISH ELECTRIC' COMPANY



THE QUEEN'S AWARD TO INDUSTRY  
1966



THE QUEEN'S AWARD TO INDUSTRY  
1967

LTD/P52

# How Pye record

Pye Records Limited make all their recordings today, whether in the studio or, as in the photograph, on location, exclusively on 'Scotch' Dynarange magnetic tape. It is one of the most important means by which Pye can give the public the high quality they expect from discs bearing the Pye name.

Dynarange has a unique low-noise oxide that gives a signal-to-noise ratio 3 to 5 db better than any conventional tape. This reduction in background noise means improved frequency response, particularly in the higher frequency range, and considerably increased dynamic

range. At the same time the exclusive 'Super-life' coating reduces magnetic oxide 'rub-off' to a negligible amount, so the life of the tape is extended, while recording heads last much longer and require far less frequent cleaning.

All these features make 'Scotch' Dynarange magnetic tape today's most advanced recording tape, and the first choice of the majority of recording studios. If Dynarange tape can be of assistance to you, please post the coupon below for technical literature and 'Scotch' magnetic tape data sheets.



**3M** MINNESOTA MINING AND  
MANUFACTURING CO. LTD.

*Manufacturers of 'Scotch' Professional Quality Magnetic  
Tape, Instrumentation Tape, Quadrature and Helical Scan  
Video Tape, Computer Tape.*

TO: MR. G. C. WRIDE, 3M HOUSE, WIGMORE STREET, LONDON W1

*Please send me technical details and specifications on 'Scotch' Dynarange Tape*

NAME .....

ADDRESS .....

*3M, 'Scotch' and Dynarange are trademarks*

WW-100 FOR FURTHER DETAILS

Wireless World, June 1968

# Test Your Knowledge

Series devised by L. Ibbotson\*

## 1. Transistor theory: bipolar and field-effect

1. A bipolar (junction) transistor when used as an amplifier has:

- (a) both junctions forward biased
- (b) both junctions reverse biased
- (c) the emitter-base junction forward biased and the base-collector junction reverse biased
- (d) the emitter-base junction reverse biased and the base-collector junction forward biased.

2. In a bipolar transistor the amount of doping in the base is much less than in the emitter. This is:

- (a) so that the base will have a high resistance
- (b) to give the transistor a high breakdown voltage
- (c) so that the current crossing the emitter junction will consist mainly of carriers injected into the base
- (d) so that there will be plenty of minority carriers in the base.

3. To obtain efficient transistor action the base width must be small. This is:

- (a) to keep the overall resistance of the device low
- (b) to keep the overall dimensions of the device small
- (c) so that most of the injected carriers will reach the collector without recombining
- (d) to keep the input and output capacitances small.

4. Three of the following together determine the value of the current amplification factor of a transistor ( $\alpha$ ). Select the "odd man out".

- (a) The fraction of the emitter current carried by carriers entering the base from the emitter.
- (b) The fraction of injected carriers which reach the collector without recombining.
- (c) The equilibrium density of minority carriers in the base.
- (d) The number of carriers produced in the collector junction by the avalanche effect (impact ionization).

5. If the reverse bias voltage between the

collector and base of a transistor is increased in magnitude, the effective base width

- (a) is unaffected
- (b) increases
- (c) decreases
- (d) in some transistors increases, in others decreases.

6. In a drift transistor the base doping is graded, the number of impurity atoms per unit volume being greatest at the emitter junction and least at the collector junction. The purpose of this is:

- (a) to give a low input capacitance
- (b) to produce a "built-in" electric field which speeds the carriers through the base
- (c) to make the maximum voltage which can be applied to the collector high
- (d) to give a low bulk resistance to the base with a high injection efficiency.

7. Silicon planar transistors are made by diffusing impurities into the silicon. As a result of this method of construction, all silicon planar transistors

- (a) must be n-p-n
- (b) are drift transistors
- (c) have uniform base doping
- (d) are symmetrical (collector and emitter roles can be reversed).

8. In a p-n-p transistor carrying a steady emitter current the hole concentration in the base is increased above its equilibrium value. As a result of this, the electron concentration in the base

- (a) increases
- (b) remains constant
- (c) decreases
- (d) drops to zero.

9. In a junction field effect transistor in normal use the junction between gate and channel

- (a) is unbiased
- (b) is forward biased
- (c) is reverse biased
- (d) may be forward or reverse biased.

10. A junction f.e.t. has the gate correctly biased and a current flowing in the channel. The channel width

- (a) is uniform
- (b) is least near the source

- (c) is least half way between source and drain
- (d) is least near the drain.

11. In a junction f.e.t. "pinch-off" occurs when:

- (a) the gate-channel junction breaks down
- (b) the number of carriers in the channel drops to zero
- (c) the depletion layer extends completely across the channel at one point
- (d) the depletion layer fills the whole channel.

12. In an insulated-gate f.e.t. (an m.o.s.t.) which is of the n-channel enhancement type the bulk material is:

- (a) n-type silicon
- (b) p-type silicon
- (c) intrinsic silicon
- (d) silicon oxide.

13. In an enhancement insulated-gate f.e.t. the "turn-on voltage" (or "offset voltage") is:

- (a) the least drain voltage which must be applied before a current will flow
- (b) the least gate voltage required to form a channel
- (c) the gate voltage required to produce "pinch off"
- (d) the gate voltage required to break down the gate insulation.

14. A depletion insulated-gate f.e.t. differs from an enhancement insulated-gate f.e.t. in that:

- (a) in the depletion type a channel exists when the gate bias voltage is zero
- (b) in the depletion type pinch-off does not occur
- (c) in the depletion type a current can flow between gate and channel
- (d) the enhancement type can only be made with an n-channel, the depletion type with a p-channel.

15. Insulated-gate f.e.t.s are very easily destroyed when being handled, and when being connected into a circuit. This is because:

- (a) they are mechanically very frail
- (b) they are easily damaged by heat
- (c) the wires are joined to the device in such a way that they break off very easily
- (d) a small charge accumulating on the gate electrode can produce an electric field large enough to destroy the insulating layer.

16. The main advantage of f.e.t.s over bipolar transistors is that

- (a) they have a better high frequency performance
- (b) they have a very high input impedance
- (c) they are less sensitive to temperature changes
- (d) they are more reliable.

\*Mr. Ibbotson is a senior lecturer in electrical engineering at West Ham College of Technology, London E.15.

# Letters to the Editor

*The Editor does not necessarily endorse opinions expressed by his correspondents*

## Audio Myths, Maths & Measurements

With respect to your editorial in the April issue, the following observations may be of interest. A worthwhile subjective improvement was made to a Tobey-Dinsdale amplifier by the use of selected special OC28s with an  $h_{FE} \approx 90$  in place of the original AD149s. Tests were then made to ascertain if any instrumental measurement could correlate with this improvement, and it was found that the response was maintained to 70kHz within trace thickness with the selected transistors and to only 50kHz with the originals. Square-wave performance at 25kHz was similarly improved.

It is of interest to note that the pre-amplifier had the customary 20kHz roll off and that the improvement between the two amplifiers was confirmed by listeners whose hearing cut off as low as 12kHz and also with programme material cutting off at 5kHz.

Miss Barbara Hayes (of C.B.S. records) suggested that the perfect amplifier would have infinite bandwidth and hence any improvement giving increased bandwidth was a step towards the ideal.

It may only be concluded that a bandwidth far beyond the audio passband is of subjective value in improving the naturalness of the sound of musical instruments, and the clearness with which they may be heard.

IVOR ABELSON,  
Fidelity Radio Ltd.,  
London, W.11.

*As Mr. Abelson refers to the Tobey-Dinsdale amplifier we asked Mr. Dinsdale for his comments. He replied:—*

I was interested to read Mr. Abelson's letter, which in many ways confirms my own observations.

First, I have always preferred the 'sound' of OC29s in my own power amplifier, as giving a subjective audible improvement over the more commonly used OC35s and AD140s. I have also been impressed with the RCA drift-field transistors type 2N2147, the excellent high-frequency response of which gives a noticeable 'cleanness of sound' to my design, although a few minor alterations to certain component values are necessary for optimum results with these devices.

I would therefore agree that a bandwidth

beyond the audio passband appears to give more natural sound to music. However I believe that this is mainly due to the fact that the higher open loop gain at the upper audio frequencies makes for less distortion. Although the power content of music at frequencies above 5kHz is only a few per cent of the total, the human ear seems to be very sensitive to harmonic distortion at these high frequencies. This applies especially to crossover distortion, which incidentally the use of high-frequency output transistors helps to minimize.

With regard to amplifiers of infinite bandwidth, I agree that in the *ideal* situation amplifiers should have an infinite bandwidth and no controls whatsoever (not even volume). However, in our imperfect world, where electro-mechanical transducers have resonances at the upper end of the spectrum, and where motors rumble at the lower end, some form of limit is desirable. Furthermore, when imperfections in the original programme material, in the recording itself, and in the playback conditions are considered, some method of curtailing the frequency response is not only desirable but essential. It is an interesting thought that if the 'ideal' system response extended to d.c., then the displacement of the pickup element as it is lowered onto the groove would be accompanied by a corresponding linear displacement of the loudspeaker speech coil away from its equilibrium position.

No, Sir, by all means let us have wider bandwidths in the power amplifier to minimize high-frequency distortion, but let us maintain in the pre-amplifier (where distortion is negligible) a realistic control over the frequency bandwidth to compensate for the imperfect conditions in which we live and listen.

JACK DINSDALE  
Farnborough, Hants.

## 'Doctoring' Recorded Sound

The item under this heading in the March issue made absorbing reading for all technically interested record users. I recognize that in a short article it is impossible to deal with all the technical tricks adopted by professional recording engineers—even if one could penetrate the secrecy barrier still prevalent in many studios—but I think the omission of

any reference to the important Dolby A.301 Signal/Noise "Stretching" System cannot go unmentioned, as the EMT "NoisEx" system is referred to.

Dr. Ray Dolby's audio noise reduction system is now employed extensively in the Decca studios, London, and by many European and U.S.A. recording, broadcasting and film companies for master recording, dubbing, transfer to discs, etc. This elegant system—with its overall 10 dB reduction of noise, hiss, etc., in the mid-range, rising to 15 dB at 15kHz—results in a much cleaner, more transparent recording, with unaltered frequency response and signal dynamics, as listeners to many recent Decca operatic and orchestral LPs will testify. Details of the technique have appeared in the *BKSTS Journal*, *Audio Engineering Society Journal*, and elsewhere.\*

Skilful "doctoring" has been very successfully employed recently by the big recording companies in transferring historic 78 r.p.m. discs to composite LPs, and I have found that practical suggestions for the best pickups, styli sizes, filtering circuits, have a tremendous fascination today for collectors of old-style discs. But the major companies are loath to publish any technical information on methods!

DONALD ALDOUS  
*Audio Record Review*,  
London, W.C.2.

\*See *W.W.* Dec. 1966, p. 632.—ED.

## Dry-joint Locator

Now that printed circuits are so commonly used in all fields of electronics, the 'dry joint' fault is even more prevalent than before. This is mainly due to the fact that printed circuits are usually soldered by the solder-bath technique, and unless the print, the component leads, and the solder temperature and cleanness are perfect, invisible dry joints occur.

Field service technicians often find it easier to locate dry joints by checking the continuity of joints and print after the approximate location of the fault has been determined. This is bearing in mind that, apart from transistors, components have a very low defect rate nowadays.

It was therefore necessary to build a continuity measuring device with the following specification:—

- 1) Low voltage on the test points (to protect in-circuit transistors)
- 2) High current (to persuade possible dry joints)
- 3) No set zero
- 4) Portable
- 5) Inexpensive

In the accompanying circuit a simple voltage regulator, a resistive bridge, and a 100-0-100  $\mu$  A meter are used. The whole circuit draws app. 250mA from a 1.5V cell. In the prototype, the bridge supply remains stable with the cell down to 0.9V.

The bridge balances with 1  $\Omega$  on the test points A & B. With a short circuit on A & B,  $R_1$  (app. 0.5  $\Omega$ ) was selected to give +f.s.d. on the meter. With A & B open circuit, due to a slight rise in the bridge supply voltage, a

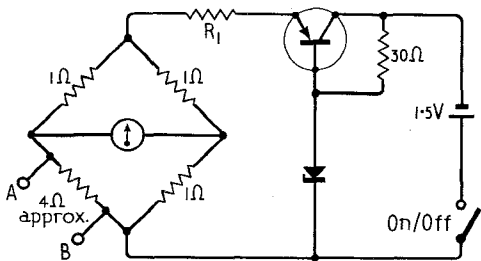

shunt of app.  $4\Omega$  was fitted between A & B to obtain a -f.s.d. The voltage and current at A & B are app. 0.2V and 100mA.

The exact values of all the components are not marked on this circuit because they depend on the transistor and Zener diode used.

This circuit has shown many would-be dry joints by indicating fluctuations up to 1 or  $2\Omega$  thus indicating them before they give trouble.

D. GOODMAN,  
Tel-Aviv, Israel.

### How important is detection?

Dr. R. C. V. Macario compares the diode detector with other systems and is critical of the performance of the diode. His diode detectors in Figs. 2 and 3 do, of course, fail to follow the modulation envelope at high modulation depths and high modulation frequencies. This, as he says, is due to the choice of the capacitor across the load resistor. This capacitor is not essential. Without it the detector output is average instead of peak, resulting in a slight loss of audio output but completely eliminating the envelope following problem.

Dr. Macario gives a formula for the optimum value of this capacitor. It shows that the detector time constant should be about  $7\mu\text{sec}$  for an audio frequency of 1kHz. His detector has a time constant of  $75\mu\text{sec}$  in Fig. 3 and  $27\mu\text{sec}$  in Fig. 2. Why so large when  $7\mu\text{sec}$  is about optimum?

The mathematics is difficult to follow because the symbols are not clearly explained.\* This is not important because the mathematics is not relevant when comparing the homodyne and the linear diode. Both are zero crossing detectors and the mathematics of one applies exactly to the other. The only practical difference which does not show in the mathematics is that the diode needs several volts to make it linear and will distort on small signals whereas the homodyne will distort on large signals, because the diodes in the shunt detector will be driven into conduction by the signal. Thus the maximum linear signal handling will be determined by the size of the square wave driving the diode bridge as stated at the top of page 56, not by  $R_1$  and  $R_2$  as stated in the caption to Fig. 8.

The comment (page 56) that a.g.c. is made more accurate is not clear. There is approximately a 20:1 loss of signal due to the  $4.7\text{k}\Omega$  and  $2.2\text{k}\Omega$  resistors and the  $600\Omega$  filter. Combined with half-wave rectification this gives an a.g.c. of about 2.5mV for the nominal carrier voltage of 100mV and, of course, less for a smaller signal. This is far too small to work the a.g.c. directly and so a high-gain,

high-stability d.c. amplifier will be needed in the a.g.c. loop, a further complication. This small signal is partly a result of the use of a shunt modulator. A larger output could be obtained from a two transformer balanced modulator.

The main criticism of the article is that the analysis and waveforms in Fig. 7 show that the behaviour of the homodyne circuit of Fig. 8 is exactly the same as a half-wave rectifier and that it should suffer from distortion during selective fading exactly as would any other envelope detector, e.g. a linear diode detector. To test this I constructed the circuit of Fig. 8 and tested it during simulated selective fading. To simulate fading, a very narrow rejection filter was placed between the signal generator and the detector. The filter was slowly tuned through the signal causing phase shift and then rejection of each component in turn. The second oscilloscope beam was used to show the envelope or diode detector output.

As was expected the homodyne output was exactly the same as the diode output. Both suffered the same severe distortion, both showed modulation frequency doubling when the carrier dropped out.

Can Dr. Macario explain why his homodyne circuit gave "an extra sharpness and greater degree of intelligibility" and why he claims that there is "more faithful following of the signal during carrier fade" when analysis and my experiments indicate that there is no difference?

M. D. SAMAIN  
University of Salford, Lancs.

I feel that Dr. Macario may be interested in my own analysis of the operation of the homodyne demodulator. This, I think shows more exactly the similarity between the homodyne and the envelope detector, and leaves me with some doubt as to the credence to be placed on the results of the listening tests.

The basis of my analysis is that the zero crossing signal derived in the homodyne is the carrier on which the received envelope information can be considered to be modulated. The zero crossing signal can therefore be represented as  $\frac{e_a(t)}{E(t)}$  where  $e_a(t)$  is the received signal and  $E(t)$  is the resultant of envelope detection. The output of the homodyne, after the product detector, is thus given by  $\frac{e_a(t)^2}{E(t)}$  which can be evaluated using the product form for  $e_a(t)$ :

$$\begin{aligned} e_a(t) &= a \cos(\omega t + \phi) \\ 1 + \frac{m_u}{2} \cos(\omega_m t + \phi_u - \phi_c) + \frac{m_l}{2} \cos(\omega_m t - \phi_l + \phi_c) &- a \sin(\omega t + \phi) \\ \frac{m_u}{2} \sin(\omega_m t + \phi_u - \phi_c) - \frac{m_l}{2} \sin(\omega_m t - \phi_l + \phi_c) & \end{aligned}$$

This is seen to be  $E(t)$ , as given by Dr. Macario, in the section of his article dealing with envelope detection, and there are no additional terms which might be attributable

to the term  $\Psi$  which was invoked in his analysis of the homodyne's action.

My own view is that there may have been some other mechanism involved in the listening tests. This would seem to involve an oscillatory condition in the zero crossing detector, caused by feedback of the out-of-balance component in the diode bridge circuit. Isolation of this component from the input to the zero crossing detector is dependent on the source impedance, and in the arrangement shown in Fig. 8 of the article would be about 40dB. Assuming, in the listening tests, a direct connection to an i.f. transformer, it can be seen that this isolation is drastically reduced, and in this instance a tuned circuit is also included. This reduction of the stability margin need not be sufficient for a completely self maintaining oscillatory circuit to be established; as indicated by G. Wareham in his comments in the May issue, this does not seem to be a necessary condition for the operation of the circuit to be modified.

It would seem, therefore, that further evidence is required to support Dr. Macario's claims for the operation of the homodyne under selective fading conditions. This evidence should be objective, and it should be supported by a more convincing theoretical treatment than that originally presented. Without this, I, for one, will remain unconvinced of the homodyne's value in broadcast reception, except where the highest possible standards of reproduction are considered to be essential.

E. A. HARMAN  
Bolton, Lancs.

### The author replies:

A good description of the operation of amplitude detectors is given by W. R. Bennett in the book, 'Communication Systems and Techniques' (McGraw-Hill 1966). In the envelope detector in order that the diode can build up the proper reverse bias on the capacitance  $C$  the source impedance should be low whilst the load impedance  $R_L$  should be such that  $C$  is a short circuit to r.f. signals, but open circuit to a.f. Since the choice of  $C$  can at best only be pitched between the conditions

$$\frac{1}{\omega_c C} \ll R_L \quad \frac{1}{\omega_m C} \gg R_L$$

it seemed reasonable to suggest the reactance of  $C$  is equal to  $R_L$  at the geometric mean frequency  $\sqrt{\omega_m \omega_c}$ , leading to the formula given in the article. It does appear however that some discrepancy has arisen over the values shown in the circuits.

On the other hand the difficulty with the straightforward diode rectifier, as Mr. Samain admits, is the volt or two to make it appear linear as well as the low source impedance just mentioned. In contrast the zero-crossing circuit as described works from a high input impedance and a low voltage swing. (The dotted circuits in my Fig. 8 were for measuring purposes only and one would normally allow much of the  $4.7\text{k}\Omega$  resistor to appear as source impedance.) As a result it becomes much easier to organize a.g.c. in the previous stages and keep them linear since the voltage swing is low, and the impedance is high.

The question of overload of the diodes in

\*We apologize for lack of clarity in the printing in some parts of this article, especially with subscripts.—ED.

the actual circuit was mentioned in the article. Why the linearity of the detector depends on  $R_1$  and  $R_2$  is because at large signal inputs the  $\mu L$  900 amplifier limits one-sidedly, whilst at low signal levels the  $\mu A$  710 switches late in one direction. In both instances the zero-crossing signal mark/space ratio changes and so the diodes are not on (or off) for as long. Since  $R_1$  and  $R_2$  fix the circuit gain, the two limits mentioned can be moved up or down accordingly.

Regarding the main contention concerning the similarity of the envelope, linear and homodyne detector, it is well known that the linear diode and homodyne detector are exactly equivalent<sup>1</sup> (at reasonable signal-to-noise ratios), because, as mentioned, the signal reinforcement makes the diode(s) appear linear. It is not true to say, however, that the envelope detector is equivalent to a linear detector when transmission impairment exists. The reason is that the linear detector takes note of both the instantaneous signal frequency and the magnitude (envelope). The instantaneous signal frequency, when phase distortion exists, is phase modulated by the term  $\psi(t)$ . This term is discussed in Professor Cherry's book<sup>2</sup> which I referred to, and whose symbolism I adhered to closely.

The actual carrier deviation due to  $\psi(t)$  is quite small though, and is difficult to observe on an oscilloscope. Using, for example, the figure of  $\pm 25^\circ$  given in Fig. 5 of the article, one can work out the frequency deviation using an analogous f.m. signal equation,

$$e(t) = \cos(\omega t + \beta \cos \omega_m t)$$

where  $\beta = \Delta f/f_m$ . Using the value of  $25^\circ$  makes  $\beta = 0.43$ , and with  $f_m = 1\text{kHz}$ , gives  $\Delta f = 430\text{Hz}$ , i.e. 0.1% deviation. What is perhaps more interesting about the small deviation of 430Hz, at 470kHz, is that to phase detect this information the discriminator requires as demanding performance as does a carrier selection filter, and so was not discussed further at the time. Nevertheless, as shown in Fig. 1, a difference between

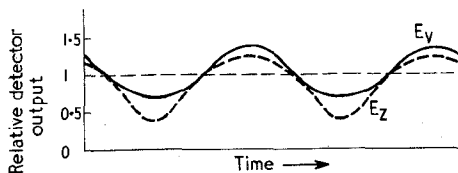

Fig. 1. Relative output for envelope and zero-crossing detector for a 50% modulated a.m. signal when the phase of the upper sideband is advanced by  $90^\circ$  relative to the carrier and the lower sideband.

$E_v(t)$  (envelope) and  $E_z(t)$  (zero-crossing), according to calculation, for the case when one sideband is rotated  $90^\circ$  relative to the other two components, exists. Similar differences also occur in other cases of distortion. Referring to the example given in Fig. 1, however, shows that the apparent depth of modulation (to the listener), which should be 50%, is only 35% in the case of  $E_v$ , but is 45% in the case of  $E_z$ . Such analysis only applies, of course, provided overmodulation does not occur. The equations given in the article do not take into account the discontinuity if the phase of the signal reverses,

as it can at the onset of overmodulation. The main interest was phase distortion which is something synchronous reception is unable to correct. In fact, calculation of the synchrodyne response  $E_z$  corresponding to Fig. 1 almost coincides with  $E_v$  and  $m_{\text{apparent}} = 30\%$ .

I feel it is the concern with overmodulation which has caused much of the difficulty. This may well be due to my unfortunate use of the word 'carrier' instead of 'signal' in the last sentence of the article. As far as the detector is concerned, the all important thing is that the 'carrier' continues to switch the diodes. I should add that when the article was submitted, it included a section headed 'conclusions', but this was subsequently used by the Editor as an introduction; if this 'summary' is read at the end, then some of the difficulties are eased.

I am entirely sympathetic to Mr. Harman's last paragraph. I have spent some time looking for reports with objective evaluations of the homodyne system, but it is perhaps worth drawing attention to a review paper on broadcast receivers<sup>3</sup> where a number of receiver systems were compared. To quote, '... all receivers ... had approximately the same audio response range. The only noticeable difference was that the quality of the homodyne receiver was superior to that of the others'.

R. C. V. MACARIO

1. 'Telecommunications', J. Brown and E. V. Glazier, Chapman and Hall, 1964.
2. 'Pulses and Transients in Communication Circuits', C. Cherry, Chapman and Hall, 1949.
3. 'Broadcast Receivers: A Review', N. M. Rust, O. E. Keall, J. F. Ramsey and K. R. Sturley, *J.I.E.E.*, 88 Pt III, 1941, p. 59.

## Component Supplies

Your reader's letter in the April issue (p.83) regarding the supply of experimental parts highlights an attitude of mind prevalent in this country and is typified by my recent experience.

I recently purchased an expensive piece of domestic electronic equipment containing transistors from a number of manufacturers. In order to trace a replacement supply of transistors, I wrote to each in turn requesting information and prices.

Of the three firms contacted to date the British transistor firm, a subsidiary of the one from whom I purchased the equipment, ignored my letter. The firm controlled from the Continent sent all the information but ignored a request for prices, probably assuming that I would eventually find a retail supplier. The firm controlled from the States sent me the prices, information and subsequently the spares requested.

J. F. CANNELL,

Mudeford, Hants.

## Shortage of Technologists

I was very surprised on reading your February editorial that there is a shortage of scientists and technologists in the electronics industry.

In view of the fact that I have in the past year, applied for six posts with electronics companies and have not been offered a posi-

tion, I am led to believe that there must be a surfeit of applicants. Now, since it appears that my services will not be required by electronics firms, I have decided to embark upon an alternative career as a lecturer.

I wonder how many other well-qualified applicants receive this sort of treatment and decide to give it up as a bad job.

D. G. PAGE  
Sheffield.

## Portable Frequency Standard

As a final comment regarding Mr. Nelson-Jones' 'Frequency Standard' may I make the following two points:

(a) Limiting is not a particularly useful method for the removal of amplitude modulation as earlier shown; a quartz resonator should be used in such a way as to allow its intrinsic stability to dominate the application; a "frequency standard" is normally regarded as a monotonic source with a spectral bandwidth less than that obtained by, say, an LC oscillator (capable of 1 p.p.m. stability over a period of one second with sound engineering design).

(b) A single quartz resonator at a nominal resonant frequency of 200kHz and with a (typical) Q of 20,000 has a bandwidth of  $\pm 5\text{Hz}$ , and hence is effective when used to eliminate modulation sidebands of the nature found on the Droitwich transmissions; this use takes advantage of the intrinsic stability of the component. The signal obtained in this way, when used as the controlling source in a phase-locked loop containing an oscillator (which need not be one which is stabilized by a quartz resonator) would provide an output signal with a stability at least two orders of magnitude better than the output from the Nelson-Jones device.

The result, for the same price, is a much better performance: This is the essence of my complaint.

Concluding, it should be said that at least three manufacturers, in fact, use the techniques I have outlined to provide an "off-the-air frequency standard"; I, therefore, cannot lay claim to any particular originality in my analyses.

LEWIS E. SCHNURR

Mid-Essex Technical College, Chelmsford.

## London Meetings

May 22nd. I.E.R.E.—"An adaptive self-phasing array and some applications to radio communication systems" by R. H. Apperley, Dr. D. E. N. Davies and M. J. Withers at 18.00 at 9 Bedford Sq., W.C.1.

May 29th. I.E.R.E. & R.T.S.—"The E.M.I. colour television camera" at 18.00 at London School of Hygiene and Tropical Medicine, Keppel St., W.C.1.

May 29th. I.E.R.E.—"Identifying system dynamics by test signals" by N. Ream at 18.00 at 9 Bedford Sq., W.C.1.

June 14th. I.P.P.S.—Symposium on the various physical aspects of cavitation at 14.15, the Physics Dept., Imperial College, S.W.7.



# Decade Frequency Standard

Essential information on a low-cost instrument providing square wave outputs at 100kHz, 10kHz, 1kHz, 100Hz and 10Hz

by Knod-V Weisberg

When making measurements on a.f. amplifiers and the like it is extremely useful to have at hand some reliable means of calibrating oscillators, providing oscilloscope marker pips etc. The instrument to be described fulfils this need at relatively low cost with the minimum of components and provides a useful source of square waves for amplifier testing as a bonus.

The generator consists of a 100kHz crystal oscillator synchronizing four emitter-coupled multivibrators each adjusted to divide by a factor of ten. An output amplifier can be connected to any frequency divider or the crystal oscillator by means of a switch thereby enabling any frequency available in the unit to be selected for use. The performance of the instrument is shown in the specification table.

## Circuit details

The crystal oscillator (Fig. 1) consists of an emitter-coupled multivibrator with the crystal as the timing element. This has the advantage over some other forms of crystal oscillator in that the positive feedback loop is isolated from the load. The bandwidth of the feedback loop is limited by the 220pF collector decoupling capacitor.

The four frequency divider multivibrators employed (Fig. 2) are all of conventional design and each employs the same circuit, only differing in the values of  $C_1$  and  $C_2$ . The natural frequency of the multivibrators is some 5% lower than that of the synchro-

nizing pulses fed to them, the half period ratios in the region of 47:53%. The synchronizing input signal is arranged to be some 20% of the emitter swing. The output amplifier (Fig. 3) is of conventional design and provides output pulses almost equal to the supply rail voltage.

## Construction

The prototype generator was built on two 4 × 6 inch printed boards, the power supply and oscillator being on one of these and the divider chain and output amplifier on the other. The layout of the components is non-critical; however, the emitter connection of the output transistor should be grounded at the output connector and not to the circuit board because of the high current in this transistor.

Point A on the first multivibrator is connected to the output of the crystal oscillator and to the 100kHz position of  $S_1$ ; point B on each multivibrator is connected to point A on the next multivibrator in the chain and also to  $S_1$ .

## Calibration

This entails setting each multivibrator to the correct division ratio by adjusting the variable 4.7kΩ resistor in each multivibrator while monitoring the output on an oscilloscope. The first step is to check the crystal output against a known accurate frequency

## Specification

output frequency	100kHz, 10kHz, 1kHz, 100Hz, 10Hz
rise time	≈ 0.1μs
output voltages	mV and 25mV
power supply	-9, 0, -9V 240mW
permissible power	
supply variation	30%
Internal standard	100kHz crystal

source before adjusting each multivibrator in turn, commencing with the 10kHz stage. The setting of the resistors should not differ much from a nominal 3.3kΩ to ensure that the transistors operate on the correct working point. If it is found that this is not the case, the value of  $C_2$  should be altered (normally it will require increasing).

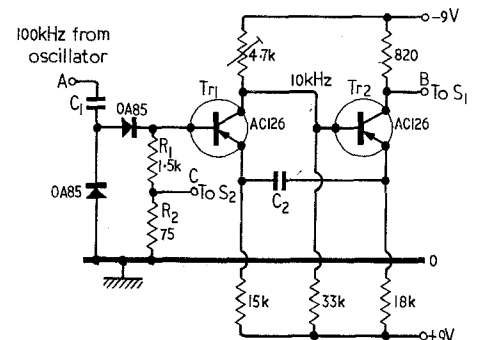

	10kHz	1kHz	100Hz	10Hz
$C_1$	1n	1n	10n	100n
$C_2$	10n	100n	1μ	10μ

Fig. 2. Only one of the multivibrator circuits is shown here. The other three are identical with the exception of the capacitance values; these are given in the table.

Fig. 3. The output amplifier circuit.

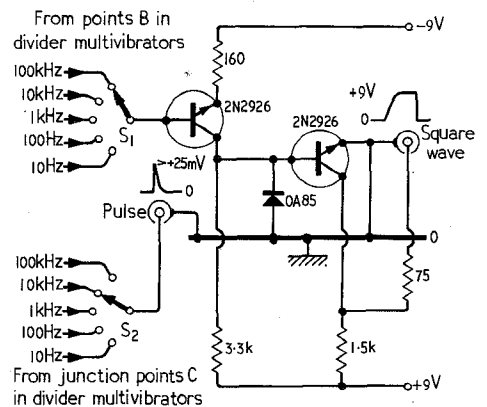
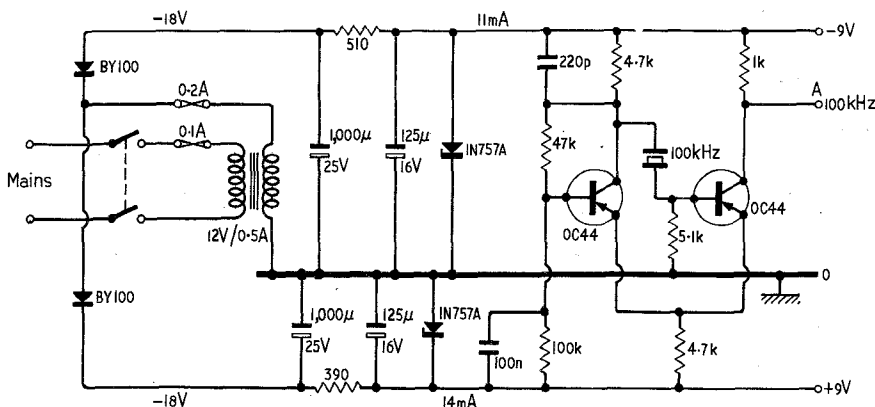

Fig. 1. The power supply and crystal oscillator circuit. Point A on the drawing is connected to the input of the first frequency divider.



# Hybrid Cascode Amplification

## High voltage gain from transistor-valve circuit: Application to power supply stabilization

by B. Alvsten and L. Bergsten

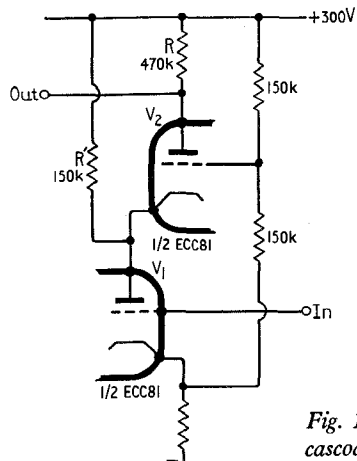
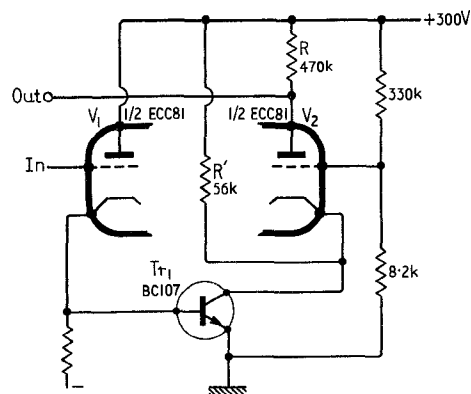

Fig. 1. Ordinary cascode stage.

Fig. 2. Hybrid cascode stage.



### Symbols used in Text

$A_h$	Amplification of the cascode stage.
$g_{m1}$	Mutual conductance of valve $V_1$ .
$g_{m2}$	Mutual conductance of transistor $Tr_1$ .
$g_{mh}$	Mutual conductance of $V_1$ combined with $Tr_1$ .
$h_{ie}, h_{re}$ $h_{fe}, h_{oe}$	Hybrid parameters of $Tr_1$ .
$I_c$	Collector current of $Tr_1$ .
$i_b$	Base signal current of $Tr_1$ .
$i_c$	Collector signal current of $Tr_1$ .
$R$	Anode load of $V_2$ .
$R'$	Bypass resistance.
$r_o$	Collector impedance of $Tr_1$ .
$r_{in}$	Cathode impedance of $V_2$ corresponding to emitter impedance of $Tr_2$ .
$r_a$	Anode impedance of $V_1$ .
$v_g$	Input signal.
$z_k$	Output impedance of $V_1$ as cathode follower.

Among the advantages of a cascode stage is its high gain. A conventional double-triode cascode stage, modified according to Attree<sup>1</sup>, is shown in Fig. 1. The approximate gain of the stage is often stated to be proportional to the mutual conductance of the lower valve and the load  $R$ , but this only holds within a certain range of circuit components as will be shown. (For a list of symbols used in the text see table.)

With the values of components given in Fig. 1, the anode current of  $V_1$  is 2-3 mA, its mutual conductance 1 mA/V, and its internal resistance  $r_a$  is about 50 k $\Omega$ . The input impedance at the cathode end of  $V_2$ , which is a function of the valve parameters and the load resistance  $R$ , is here about 12 k $\Omega$ . A rough calculation shows that  $\frac{3}{4}$  of the signal current from  $V_1$  is usefully working on  $R$ , the rest being lost through  $r_a$  and  $R'$ . The amplification of the cascode stage is about 360 as compared to 470 under the idealized assumption that it should be equal to  $g_{m1} \times R$ . If anode current of  $V_1$  is raised to 10 mA by a reduction of  $R'$  to 10 k $\Omega$ , the mutual conductance of the valve rises to 5 mA, and  $r_a$  is lowered to about 10 k $\Omega$ . Now less than  $\frac{1}{3}$  of the signal current usefully enters through  $R$ , and in spite of the much larger mutual conductance, the amplification will be only doubled to about 700. To get a higher figure it is necessary to raise the value of  $R$ . But this increases the input impedance of  $V_2$ , which means that still more of the signal current is lost in  $r_a$  and  $R'$ . By circuit adjustments like these, one can achieve an amplification of about 1,500 in practical cases, but not much more. One negative effect of an increased value of  $R$  will be a smaller bandwidth. On the other hand, by the addition of a single transistor, which replaces valve  $V_1$ , the amplification is easily made one order of magnitude greater, while still keeping  $R$  relatively small, and by the addition of one further transistor, added to give a "triple-cascode" stage, an amplification of 100,000 times becomes within reach. This is possible because the mutual conductance of a transistor is easily made say 50 times greater than that of a valve.

The new stage is shown in Fig. 2, with the transistor fed from a cathode follower. The measured mutual conductance of a transistor BC107 as a function of the collector current is shown in Fig. 3, the upper curve, and in the same diagram the

smaller mutual conductance of the combination transistor cathode-follower is also shown. Current through the cathode-follower is 1 mA. A collector current of 2 mA for the transistor, with  $R'=100$  k $\Omega$ , gives a combined mutual conductance of 50 mA/V resulting in a correspondingly large collector signal current in the transistor. But, as we have already seen, the impedance relationships in the stage are important too. Therefore, the output impedance of the transistor is also plotted as a function of collector current in the same figure, Fig. 3. It is about 45 k $\Omega$  at 2 mA, and is a somewhat smaller figure than the corresponding figure

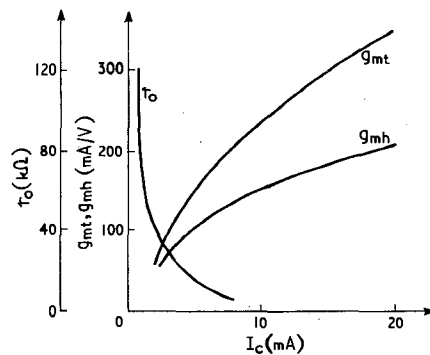
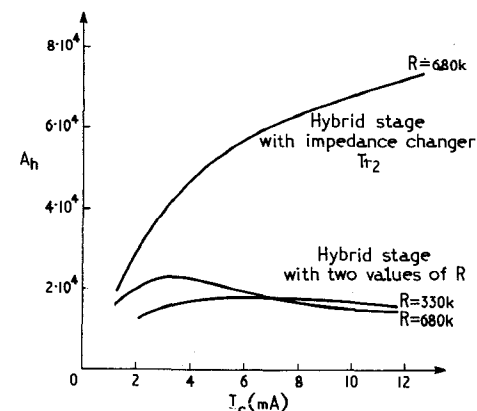

Fig. 3. Showing transistor output impedance  $r_o$  and mutual conductance  $g_{mt}$ , also the mutual conductance of a transistor and valve combination  $g_{mh}$  as functions of collector current.

Fig. 4. The two lower curves show the amplification of the hybrid stage  $V_1$ ,  $Tr_1$  and  $V_2$  with two values of  $R$ , and the upper curve the amplification of the hybrid stage with the impedance changer  $Tr_2$  included.



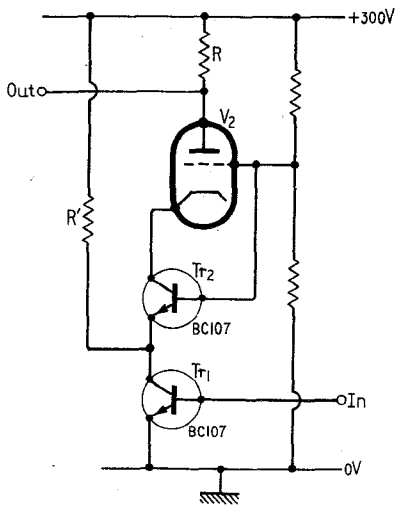

Fig. 5. Circuit diagram of the amplification stage with  $Tr_2$  as an impedance changer, cathode follower omitted.

for  $V_1$  of Fig. 1. The hybrid cascode stage as shown in Fig. 2 has a voltage amplification of 12,000, i.e. one order of magnitude greater than the valve cascode. There is practically no change in frequency response, since this depends in the first place on the anode circuit of  $V_2$ . Let us now look at the possibilities of still higher amplification by adjustments or refinements of the hybrid stage. The important parameters are still the load resistance  $R$  and the mutual conductance of the lower active device, here  $Tr_1$  and  $V_1$  taken together.

The two lower traces in Fig. 4 show the change in voltage amplification by the variation of collector current for two values of  $R$ : 330 k $\Omega$  and 680 k $\Omega$ . Nothing is gained by a collector current greater than 4 mA, and the reason for this is the reduction of the transistor output impedance and the external resistance  $R'$ , whereby an increasing amount of signal current passes through these resistances and is lost as useful current through  $R$ .

If a second transistor is inserted as an impedance changer,  $Tr_2$  of Fig. 5, the high mutual conductance of  $Tr_1$  at higher collector currents can, however, be used to advantage in spite of the accompanying low output impedance.  $Tr_2$  has a sufficiently low input impedance to give roughly short-circuit conditions to  $Tr_1$ , and it has, since it is driven by a current source on the emitter side, a high output impedance, of the order of 1 M $\Omega$ . Totally, only a small proportion of the signal current is now lost, so that the voltage amplification is again to a good approximation equal to  $R$  multiplied by the mutual conductance  $g_{mh}$  of Fig. 3. This has been confirmed by measurements, the results of which are given as the top curve of Fig. 4. The curve agrees in growth fairly well with the curve for  $g_{mh}$  of Fig. 3. The amplification was measured for  $R=680$  k $\Omega$ .

These results have been applied to a small power supply. The power supply was originally built with an ordinary cascode stage. Relevant parts of the circuit are shown in Fig. 6. The modified power supply is shown in detail in Fig. 7. It is seen that the valve  $V_1$  of Fig. 6 has been replaced by

the transistor  $Tr_1$ , and it has been changed to a cathode-follower preceding the transistor. Thereby the voltage-setting potentiometer remains unloaded. It should be emphasized that in the voltage stabilizer of Fig. 7 the high amplification of the hybrid cascode stage is not utilized to full advantage. There is still a considerable percentage change in output voltage for changes in supply voltage, and also for changes in load resistance, and for the same reason in both cases, namely a change in the grid-to-cathode potential of  $V_1$  on account of changing filament voltage, i.e. cathode temperature. A long-tailed pair arrangement would give better results, but probably the best way would be to replace  $V_1$  by a solid-state device, for instance an f.e.t. transistor, adjusted for minimum temperature drift. However,

with or without these refinements the result is a very low output resistance of the power supply, and this has been achieved with very little work and at low cost.

Acknowledgement is due to Professor S. Berglund, who suggested this investigation.

#### REFERENCES

1. "A Cascade Amplifier Degenerative Stabilizer", by V. H. Attree, *Electronic Engineering*, April 1955, page 174.

#### APPENDIX

The mutual conductance of a combination cathode-follower and emitter-grounded transistor.

If  $h$  parameters are used for the transistor, the equivalent circuit for a cathode follower driving a transistor in common emitter coupling

Fig. 6 (Right). Circuit diagram of the original power supply.

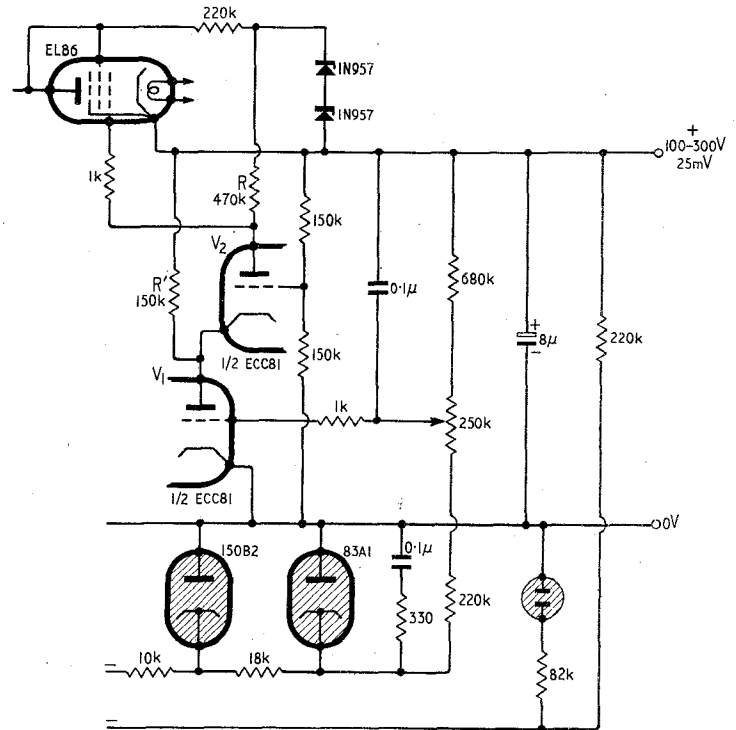
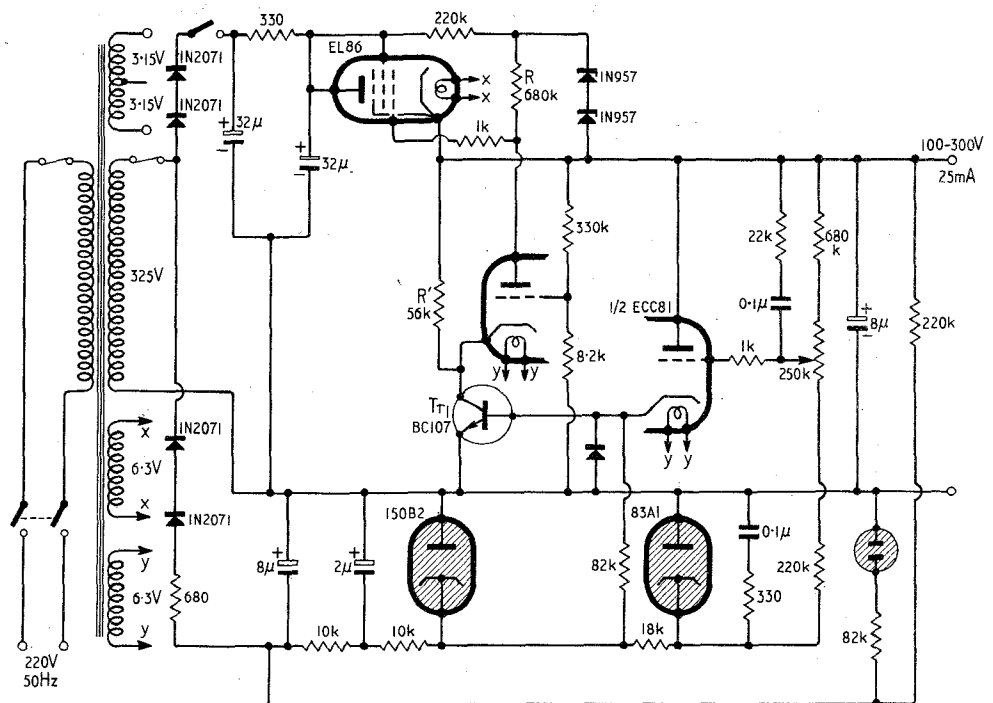

Fig. 7 (Below). Circuit of power supply with hybrid cascode stage.



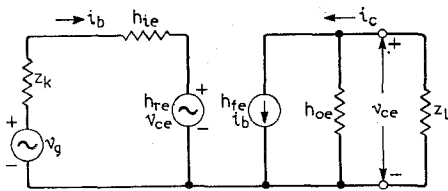
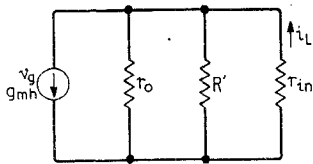

Fig. 8. Equivalent circuit of a cathode follower and transistor.

Fig. 9. Constant current generator with internal resistance  $r_o$  loaded by bypass resistance  $R'$  and input impedance  $r_{in}$  of following device.



becomes that of Fig. 8, where the voltage source  $v_g$  and the impedance  $z_k$  form the Thévenin equivalent of the cathode follower. Note that  $v_g$  also is the input voltage on the grid of the valve. In the derivation of the mutual conductance  $g_{mh}$  of the combination, the load resistance is regarded as zero, which means that the influence of  $h_{re}$  is omitted.

Thus  $i_c = h_{fe} i_b$  . . . . . (1)  
and from the base circuit we get

$$i_b = \frac{v_g}{z_k + h_{ie}} \dots \dots \dots (2)$$

Eq. (1) and (2) combined give

$$i_c = \frac{h_{fe} v_g}{z_k + h_{ie}} \dots \dots \dots (3)$$

and from the definition of mutual conductance we now have for the hybrid combination

$$g_{mh} = \frac{i_c}{v_g} = \frac{h_{fe}}{z_k + h_{ie}} \dots \dots \dots (3)$$

The variation of  $h_{fe}$  with collector current is small in the current interval in which the transistor is assumed to operate. Therefore  $h_{fe}$  may be treated as a constant. The parameter  $h_{ie}$  is roughly proportional to  $1/I_c$ . With these approximations we get

$$g_{mh} \propto \frac{1}{a + \frac{1}{I_c}} \dots \dots \dots (4)$$

where  $a$  is a constant. This is in good agreement with the curve  $g_{mh}$  of Fig. 3.

*The voltage amplification of a hybrid cascode stage.*

We are now ready to derive an expression for the amplification of our cascode stage, when the lower triode section of Fig. 1 is replaced by a combination according to the above.

Assuming that no grid current is drawn in  $V_{22}$ , all the current that is fed in to this valve at the cathode, also goes through the anode load resistance  $R$  of that valve.

The same is, to a very close approximation, true about the emitter input current of the second transistor, inserted as shown in Fig. 5, if this transistor has a high current gain.

The main interest is now in the collector circuit of transistor  $Tr_1$ , the equivalent circuit of which is shown in Fig. 9. The current generator is  $v_g \cdot g_{mh}$  and the input impedance at the cathode of  $V_2$  at the emitter of  $Tr_2$ , in both cases denoted by  $r_{in}$ , is seen to be in parallel with the transistor output impedance  $r_o$ , and the bypass resistance  $R'$ .

If the parallel combination of  $r_o$  and  $R'$  is called  $R_p$ , it is easily found by the law of current division, that

$$i_L = v_g \cdot g_{mh} \frac{R_p}{R_p + r_{in}} \dots \dots \dots (5)$$

where  $R_p = \frac{r_o R'}{r_o + R'}$

Dividing by  $v_g$  we get a transfer conductance for the whole combination  $V_1 - Tr_1$ , to the input of  $V_2$ , which is denoted by  $g_{ma}$ .

$$\text{Thus } g_{mo} = g_{mh} \frac{R_p}{R_p + r_{in}} \dots \dots \dots (6)$$

The voltage amplification  $A_h$  is now simply given as  $A_h = g_{mo} R$  . . . . . (7)

since the current  $i_L$  through  $r_{in}$  also passes through  $R$ , as has already been stated. For a comparison of the above expression for  $A_h$  with the measurements presented in Fig. 4, we have to give  $A_h$  in detail.

$$A_h = R \cdot g_{mh} \frac{r_o R'}{r_o R' + r_{in}} \dots \dots \dots (8)$$

Within certain limits  $r_o \propto 1/I_c$  and also  $R' \propto 1/I_c$ . In view of this we get an approximate relationship between  $A_h$  and  $I_c$ .

$$A_h \propto \frac{1}{I_c + b + c/I_c} \text{ and } b \text{ and } c \text{ constants} \dots \dots \dots (9)$$

Eq. (9) states that  $A_h$  goes towards zero when  $I_c \rightarrow 0$  as well as when  $I_c \rightarrow \infty$ . This indicates that  $A_h$  has a maximum, which is in agreement with the measurements presented in Fig. 4.

*Both authors are at the University of Lund, Sweden. Bengt Erik Alvesten graduated in physics in 1960 and in electronics in 1964 and is now an assistant in electronics research and education. Lasse O. Bergsten graduated in physics in 1965 and is now doing post graduate research.*

## Announcements

The 6th **International Power Sources Symposium**, organized by the Joint Services Electrical Power Sources Committee, will be held at the Hotel Metropole, Brighton, Sussex, from 24th to 26th September. Papers presented will cover a wide range of subjects concerned with research, development and application of primary and secondary battery systems, fuel cells, solar cells etc. Further information and registration forms from J.S.E.P.S.C., P.O. Box 136, Croydon, CR9 2EG, Surrey.

**Signal Processing**, with emphasis on underwater acoustics, is the subject to be covered at the Advanced Study Institute being sponsored by N.A.T.O., the Raytheon Company of America and the Dutch National Defence Research Organization, to be held in Holland from 12th to 23rd August. The programme includes 35 papers presented by scientists from the U.S.A., Canada and Europe. Application forms and information bulletins can be obtained from the Organizing Committee, c/o Holland Organizing Centre, 16 Lange Voorhout, The Hague, Netherlands.

A vacation school on "**Statistical methods of system identification**", arranged by the professional group on control theory of the I.E.E. Control and Automation Division, is to be held at the University of Warwick from 16th to 20th September. Further details and application forms may be obtained from the Divisional Secretary, (Control and Automation), I.E.E., Savoy Place, London W.C.2.

A residential vacation school on **electrical measurement practice** is to be held at the University of Manchester Institute of Science and Technology from 14th to 26th July. Further details can be obtained from The Secretary, I.E.E., Savoy Place, London, W.C.2.

The British Amateur Television Club will be holding its 1968 **Amateur Television Convention** on September 14th in the I.T.A. Conference Suite, 70 Brompton Road, London, S.W.3.

Australia's 12th national radio and electronics engineering convention and exhibition will be held at the Wentworth Hotel, Sydney, in May 1969.

At the 23rd Annual General Meeting of the **British Radio Equipment Manufacturers' Association** on May 2nd the following Member firms were appointed to the Council: A. J. Balcombe, General Electric Co., Hacker Radio, Philips Electronic and Associated Industries, Pye of Cambridge, Radio Rentaset Products (Baird Television Division), Rank-Bush-Murphy, Standard Telephones & Cables, and Thorn Electrical Industries. Lord Thornycroft, chairman of Pye of Cambridge, was elected president of the Association.

The Muirhead Group, of Beckenham, Kent, have won an order worth approximately £100,000 from the Soviet Union for their latest type of newspaper page **facsimile equipment** and some wire photo products. Publications will be transmitted on this equipment by radio from Moscow to towns hundreds of miles away.

**Aircraft navigational beacon transmitters** worth more than \$A50,000 have been delivered to the Australian Department of Civil Aviation by Commonwealth Electronics Pty Ltd. The transmitters are non-directional beacons designed to operate in the frequency range of 200 to 415kHz.

A range of **tantalum electrolytic capacitors**, manufactured by Ero-Tantal GmbH, of West Germany, are now available from G. A. Stanley Palmer Ltd., Island Farm Avenue, West Molesey Trading Estate, Surrey.

**Mullard Ltd** is to undertake the manufacture of cathode-ray tubes on behalf of Pye; both companies are subsidiaries of Philips Industries. Mullard have acquired the major part of the assets of Cathodeon Electronic Ltd who have ceased to manufacture c.r.t.s.

Plans have been made to merge W. G. Pye & Company Ltd and Unicam Instruments Ltd, as part of a policy of rationalization by Pye Holdings Ltd. The new company will be known as **Pye Unicam Limited**.

Tokyo Shibaura Electric, of Japan, manufacturers of **Toshiba** products, have opened an office at Premier House, 12 Hatton Garden, London E.C.1.

**Racal Communications Ltd**, of Western Road, Bracknell, Berks, have been awarded a contract worth £100,000 by the British Army for the military version of a solid-state h.f. receiver.

Aircraft Supplies Ltd, of 506 Wallisdown Road, Bournemouth, Hants, have taken over the production, repair, maintenance and information play-back of the **Midas CMM3/RB** accident data recording system.

Teleng Ltd are exhibiting a range of **v.h.f. communal aerial equipment** at a two-day show to be held on August 28th and 29th at the Kensington Close Hotel, London W.8.

Racal Instruments Ltd have signed an agreement to market in the U.K. the programmable voltage sources, known as "**Codavolt**", and programmable frequency synthesizers, known as "**Codasyn**", manufactured by the French company Adret Electronique.

**Antex Ltd**, of Croydon, Surrey, have moved to Mayflower House, Armada Way, Plymouth, Devon.

The Kenya Ministry of Tourism and Wildlife have placed a £30,000 order for **s.s.b. radiotelephones** with the Communications Division of Redifon Ltd. These will link field offices in park and lake areas with the Ministry's headquarters in Nairobi.

The M-O Valve Company Ltd, a subsidiary of G.E.C., have announced the appointment of Metropolitan Supply Company, of 468 Park Ave. South, N.Y. 10016, as **American distributors** for their range of products.

Tectonic Industrial Printers Ltd, of Circe Works, Oxford Road, Wokingham, Berks, have changed the company name to **Tectonic (Electronics) Ltd**. The company are mainly concerned with the manufacture of printed circuits.

The electronic research laboratories of Louvain University, Belgium, are organizing a Summer course on "**Logic circuits and systems**". Commencing 2nd September, the course will be held in Dutch and French. Further details from Prof. H. P. Debruyne, Electronic Research Laboratories, Section: Circuits and Systems, 94 Kardinaal Mercierlaan, Heverlee, Belgium.

# The Audio Fair at a Turning Point

## General and technical trends

The possession of good quality sound reproducing equipment is no longer restricted to an exclusive band of enthusiasts with plenty of time, money and that kind of technical expertise which comes from relentless pursuit of an ideal. Anybody who can afford to put down about £100 on a counter can immediately own a quite respectable stereo reproducing chain, as a recent issue of *Which?* made clear (although a somewhat larger sum of money—about £200—is needed for real hi-fi). This spreading of the benefits of good reproduction to a larger public is, of course, a good thing. It is reflected in the changing character of the annual London Audio Festival and Fair, which from being a small event intended for specialists and run by an engineering society (the old British Sound Recording Association) has now become a large commercial affair open to the general public. (Total attendance over the four days of the 1968 Fair is estimated as 40,000 people.)

This situation is in general deplored by engineers and audiophiles, who tend to see the work they have fostered with love and enthusiasm over the years being gobbled up by big business interests which are concerned only with its profit potential. Of course, this attitude can be criticized as unrealistic. Money must be obtained from selling commercial products to support future technical development. Probably the most important thing is to maintain a good balance between the purely technical and the purely commercial interests. Fortunately, there are still a few audio manufacturing firms in existence which have achieved this balance. The engineers who run them seem to have discovered the secret of being commercially successful without losing their original enthusiasm for technical exploration. Consequently the audio industry still has an engine driving it forward: it has not yet reached the stage of merely free-wheeling downhill under its own dead weight.

As far as the Audio Fair itself is concerned it seems possible that organizational changes are about to take place. C. Rex-Hassan, the director, has hinted that it may be necessary to link up with some established trade—though he has not said what sort of trade he has in mind. He has also complained of the considerable cost of hiring a large hotel such as the Hotel Russell for the event. If this means that the principle of providing rooms for live demonstrations of equipment

is to be abandoned, it will be disastrous: without demonstrations the Audio Fair will lose its whole point and degenerate into just another exhibition.

The 1968 Festival and Fair did not reveal any startling technical developments. Equipment is evolving on fairly predictable lines, with continuing emphasis on domestic convenience. The bookcase-size loudspeaker, for example, is now well established, and considerable design effort has gone into making it produce acceptable sounds. Here, stereophony helps considerably because the effect of spaciousness seems somehow to make the lack of bass less important. Nevertheless some manufacturers were brave enough to put on comparative demonstrations of bookcase and larger loudspeakers, and no doubt this could be regarded as a respectable form of "switch selling" for the larger models.

The electronics part of the hi-fi chain can be divided into two main categories of hardware. First there are the systems which use "separates", that is, individual tuners, control units and amplifiers which can be selected separately and assembled into a chain according to the user's requirements. At one time this was the only basis on which the audiophile could build up his equipment, and one which required a good deal of technical knowledge in addition to a desire for high-quality reproduction.

Latterly, from about the time when transistor circuits began to be incorporated in equipment designs, there has been a growing trend towards a second category which combines the tuning, control and amplifier functions in one "integrated" unit, in some cases even including the record player, leaving the user only the task of selecting a suitable loudspeaker or pair of loudspeakers. Both categories are among the new items described on the following pages, which in all but one instance use semiconductors exclusively. Incidentally, some f.m. tuner units favour the use of f.e.t.s for r.f. amplifier and mixer stages because these allow large signal handling capacity without introducing cross-talk distortion.

A very large category of equipment at the Fair was tape recorders. Drive belts are at last falling in popularity and we are seeing more three-motor tape transport systems, some with outside rotor motors in all three positions. The resulting reduction in the number of mechanical components leads to quieter machines—a fact that is not revealed

in specification sheets as mechanical noise level is still not given in manufacturers' literature. One company has gone a step further and eliminated the wheels needed for speed change, an all-electronic system being employed. Standardization of equalization characteristics seems to be very much a thing of the future, C.C.I.R., DIN, I.E.C. and N.A.B. standards all being used in the machines seen at the Fair. In at least one case a machine could be switched between two of the standards and in another variable equalization was used. It was disappointing to find no sign of the integrated circuit in tape recorders. However, a few manufacturers are using f.e.t.s in low-level amplifier circuits.

Some of the selected items dealt with in the following pages were seen at small individual exhibitions held in other London hotels at the same time as the Audio Fair.

## Electronic Speed Control Tape Recorder

The motor speed control system employed in the latest tape recorder from Revox, the 77A, uses no fewer than nine transistors and eight diodes. Full details on how the circuit operates have not been released, but it would appear that the system consists essentially of a closed loop servo controlling the speed of an outside rotor capstan motor. This motor has a number of grooves, or slots, machined in its periphery that rotate in close proximity to a "tachometer type" magnetic head. Pulses appearing at the output of this head have a frequency directly proportional to capstan motor and therefore tape speed. The pulses are applied to a high gain amplifier with a complementary symmetry output stage which is stabilized with a hefty amount of negative feedback. The output of the amplifier drives a frequency discriminator with a d.c. output determined by the difference between the frequency of the signal from the magnetic head and that of the discriminator tuned circuit. This difference, or error, voltage is again amplified and applied to a transistor whose collector and emitter terminals are connected to the + and - "outputs" of a rectifier full-wave bridge in much the same way as an s.c.r. is sometimes connected in control circuits. The capstan motor is connected in series with the a.c. terminals of the bridge and the a.c. supply line. The bridge effectively connects the motor in series with the output transistor which then controls the amplitude of the voltage applied to the motor. Speed changes are accomplished by electronically switching, using diodes, a capacitor

into the discriminator circuit which alters the resonant frequency of the tuning element. Two speeds are available, 9.5 and 19 cm/sec that are maintained within  $\pm 0.2\%$  by the control system; wow and flutter (weighted) is 0.1%.

A variety of two- and four-track models are available that can be supplied with or without power amplifiers and with a choice of cabinets. The power amplifiers provide 8W per channel (r.m.s.) into 4-16 $\Omega$  at less than 1% distortion. Equalization is switchable and may be to N.A.B. or I.E.C. standards, the frequency response at 9.5cm/sec being from 30Hz to 20kHz  $+2\text{dB}/-3\text{dB}$ . Signal-to-noise ratio, weighted (filter C.C.I.F.), is better than 58dB at 19cm/sec.

Three inputs per channel are provided these being, microphone (switchable Hi-50 $\Omega$ -150 $\mu\text{V}$  and Lo-100k $\Omega$ -2mV), radio (33k $\Omega$  2mV) and auxiliary (1M $\Omega$  40mV). In addition to the loud-speaker outputs, available if the power amplifiers are fitted, two other outputs are provided—600 $\Omega$  2.5V and 2.5k $\Omega$  1.2V.

The recorder will accommodate up to 27cm diameter tape spools and is handled in this country by C. E. Hammond & Co. Ltd., 90 High Street, Eton, Windsor, Berks.

W.W. 341 for further details

## Richardson Valve Amplifier

One manufacturer who believes that the potentialities of valves have not been fully exploited and that valve circuit designs should not be too hastily discarded is Richardson Electronics. This company, a newcomer to the domestic hi-fi market, was demonstrating a stereo system based on their MA135 valve power amplifier, the circuit diagram of which is shown. They claim that valves offer the advantages of minimal distortion at all levels and the ability to drive all types of loads without risk of damage or instability. Loud-speaker systems, they say, may have an impedance at 50kHz which is many times that of the rating and to provide optimum performance when driving this type of load, a special network is incorporated in the output stage to compensate for this. The first stage of the amplifier comprises a high gain cascode stage which feeds the pentode section of an ECF82 phase splitter. Balanced drive to the output valves is ensured by the setting of a pre-set control in the anode circuits and balanced drive at high frequencies is obtained by an RC network incorporated in the cathode circuit. Stability with any type of load is achieved by limiting the high and low frequency gain by means of an RC network in the anode of the cascode stage. The amplifier, model SA170, has an output of 30W r.m.s. for 0.1% distortion and a sensitivity of 250mV. Frequency response is 20Hz to 20kHz  $\pm 0.5\text{dB}$ . Outputs are provided for loudspeakers of 4, 8 or 16- $\Omega$  impedance.

A complementary control unit for the SA170 amplifier is the all-transistor SCP1 which has a sensitivity on disc of 2mV with a noise figure better than 70dB. Inputs are provided for disc, tape, microphone and two auxiliary (one 50mV at

Richardson SA170 stereo power amplifier.

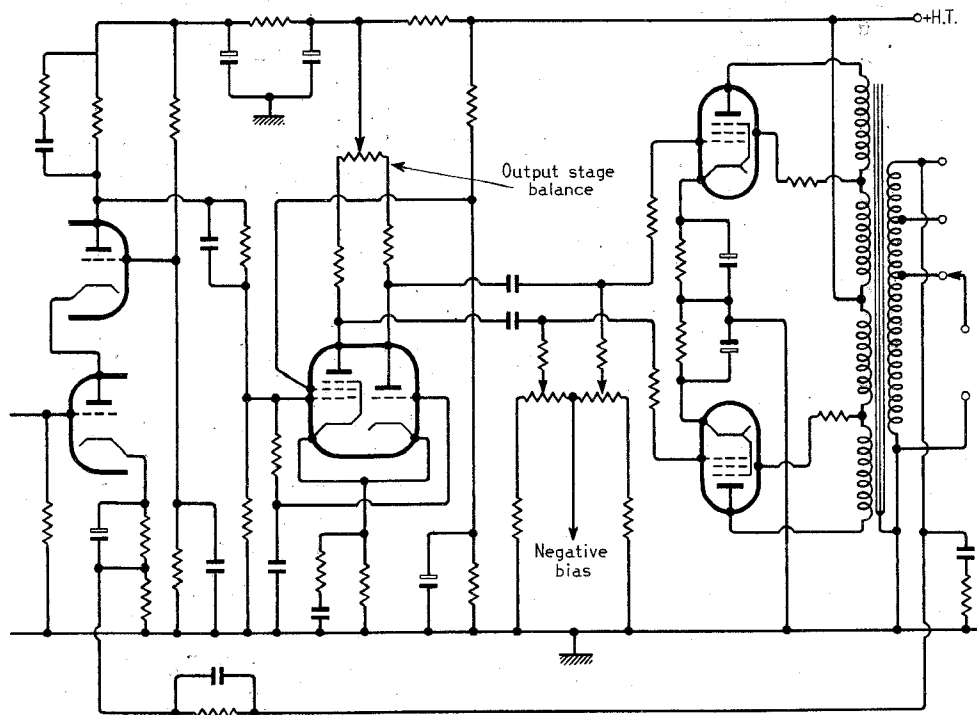
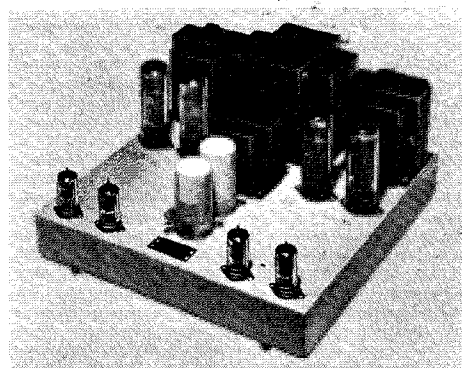

Circuit of the Richardson SA170 showing the method of balancing the output valves.

2M $\Omega$  and the other 250mV at 100k $\Omega$ ). The unit contains its own power pack and has two switched mains outlet sockets for feeding a turntable and the power amplifier. The front panel features a phase-reversing switch which operates on the left-hand channel only to simplify speaker phasing and compensate for recording errors. Price of the SA170 amplifier is £60 and of the SCP1 control unit £45. J. Richardson Electronics Ltd., 43B Hereford Road, London W.2.

W.W. 334 for further details.

## Slot Stereo

An American tape transport mechanism employing eight-track endless loop recorded cassettes forms the basis of a tape player system new to the British domestic scene, introduced by Slot Stereo. The cassettes employ quarter-inch tape that is pulled past the playback heads from the centre of a reel and re-wound on the outside of the same reel as is standard practice in endless loop cassette systems. To reduce friction the back of the tape is coated with a thin lubricating film of graphite. Track changing is achieved by moving the heads with a solenoid and cam system actuated by a length of aluminium foil spliced into the tape. In this way the track is changed once every revolution of the tape loop so that each of the four stereo tracks is played in turn before being automatically repeated. Tracks can also be switched manually. The player employs a 12-V d.c. motor that is governed electronically by measuring the back e.m.f., which is a function of speed, and comparing this with a reference voltage. Any difference between these voltages results in an error signal which is used to control motor speed.

Three versions of the tape player are available differing in application and cost but employing the same basic tape mechanism.

The car unit measures 8 $\frac{1}{2}$  x 3 x 7 $\frac{1}{2}$  inches (21.5 x 7.6 x 19cm), requires a 12-V positive earth supply at 1.5A, uses 14 transistors, delivers 4W r.m.s. output per channel with a 40dB signal-to-noise ratio and costs 47gn.

The 'satellite' unit for home use in conjunction with an existing amplifier system has a performance similar to that of the car unit except that it uses a mains supply and has a low level output only. It costs 47gn.

The home unit incorporates twin 8W r.m.s. output amplifiers but except for the case is the same as the 'satellite' unit, and costs 85gn.

A large variety of recorded music is available in the eight-track cassettes. Incidentally, the R.I.A.A. track pairing standard is employed, i.e. 1 with 5, 2 with 6, 3 with 7, and 4 with 8. We understand

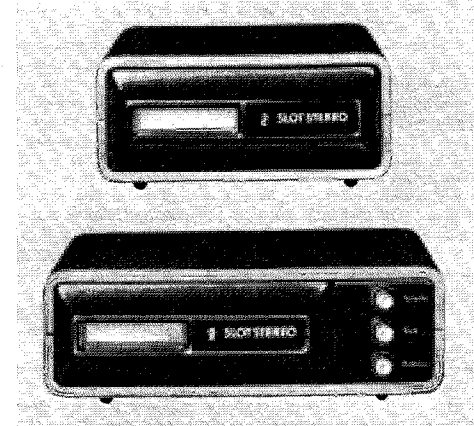

The domestic Slot Stereo cassette tape player with (above) the 'satellite' unit.

that Slot Stereo intend to introduce a radio tuner that will slot into the tape players in place of the tape cassettes! Slot Stereo Ltd., 36 Hertford Street, London W1.

W.W. 314 for further details.

## Grundig Stereo Tuner/Amplifier

Five wavebands and 40W of output power (continuous rating) are provided by a new Grundig stereo tuner/amplifier model RTV600 which is fully 'integrated' with pre-amplifiers and control unit. A total of 53 transistors and 31 diodes are used with f.e.t.s featured in the front end. On the f.m. range (87-108MHz), six separately tuned programme selectors allow five v.h.f. stations to be pre-set, the sixth selector being for manual tuning. On a.m., the waveband coverage is 145-350kHz, 510-1,620kHz, and 3.15-22.5MHz in two bands. A s.w. fine-tuning control has a range

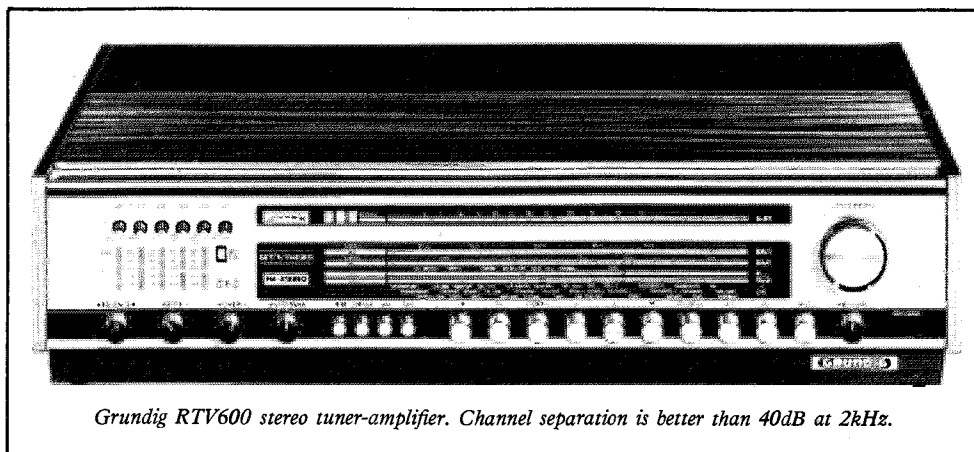

Grundig RTV600 stereo tuner-amplifier. Channel separation is better than 40dB at 2kHz.

of  $\pm 60$ kHz. Sensitivities are  $1.5 \mu V$  for 15kHz deviation (f.m.) and  $6.5-10 \mu V$  through the a.m. ranges. Frequency drift is  $1 \text{ kHz}/^\circ\text{C}$  which is compensated by a.f.c. with a capture range of  $\pm 250$ kHz. Signal-to-noise ratio is 68dB at 21W, output deviation at linear frequency response measured from aerial to mono loudspeaker output. Pilot tone suppression is 40dB at 19kHz (55dB at 38kHz). A mono/stereo selector is incorporated in the integral decoder controlled by the input level, and stereo channel separation is better than 40dB at 2kHz measured from the aerial input to the loudspeaker output.

In the amplifier section frequency response is 50Hz-16kHz  $\pm 1$ dB. Switchable inputs are provided for magnetic or crystal pickups, with pre-amplifier and correction networks. The output may be connected to loudspeakers with impedances between 4 and  $16 \Omega$ , the full rated power is available for impedances between 4 and  $7 \Omega$ . The output transistors are protected against overload by an automatic circuit which disconnects the amplifier channel if the load exceeds the maximum permissible figure. In addition, an excess temperature switch disconnects the amplifier if the maximum permissible temperature is exceeded. In both cases, the tuner will revert to correct operation when the source of the excess load or the excess temperature has been removed. Controls include a mono/stereo press-button selector, stereo balance control, scratch filter and treble and bass controls. The tone controls have a range of  $-20$ dB to  $+15$ dB at 20kHz and 20Hz respectively. When they are set at zero, the response is linear. Dimensions are approximately  $60 \times 15 \times 30$ cm. Price: 198gn. Grundig (GB) Ltd., Newlands Park, Sydenham, London S.E.26.

W.W. 333 for further details.

## 2 cu.ft Loudspeaker System

The Model DM3 loudspeaker system shown by Bowers & Wilkins is characterized by having an enclosure of moderate size— $0.057 \text{ m}^3$  (2 cu.ft)—and by a new design of bass unit which has an elliptical cone of laminated structure. This bass unit, developed by E.M.I., measures  $34 \times$

Laminated cone material used in the Bowers & Wilkins loudspeaker.

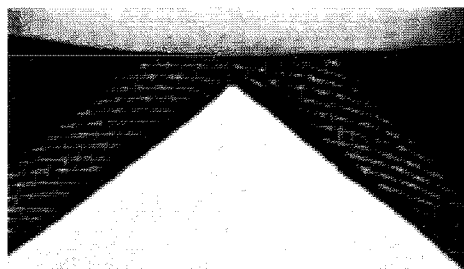

$20.5$ cm ( $13\frac{1}{2} \times 8\frac{1}{2}$ in) and the laminated cone material consists of a mesh of fibre glass sandwiched between two layers of other fibrous material (see photo). Middle frequencies are handled by a pressure unit operating from 3kHz to 14 kHz and the remainder of the range, 14kHz to 25kHz, by a high-frequency unit. Frequency response is better than  $\pm 2$ dB from 60Hz to 14kHz and better than  $\pm 5$ dB from 40Hz to 25kHz. The cabinet, measuring  $72.5 \times 40.3 \times 29.5$ cm, is a vented type and contains a membrane absorber and wool fibre. Power handling capacity is 15 watts continuous (25 watts music power). Distortion, with 10 watts continuous input, is: 60Hz, 3%; 200Hz, 2.5%; 1kHz, 1.2%; 5kHz, 1.0%; 10kHz, 2%. Bowers & Wilkins Electronics Ltd., Worthing, Sussex.

W.W. 326 for further details.

## Ferrograph Series Seven

The gleaming extruded aluminium trim and polished teak cases of the new Ferrograph range of tape recorders is a welcome change after the austere black and grey that has characterized this company's products for the past eighteen years. The models making up the new range, known as series seven, consist of a number of options based on the same design. Facilities available are mono half-track, stereo half track, stereo quarter track, three tape speeds, 19 to 4.75 cm/sec or 38 to 9.5cm/sec, with or without output stages and choice of cabinet—portable or natural wood or, if desired, the machine will be supplied uncased, for inclusion in an existing cabinet. The basic models are made up from various compatible combinations of these options and range in price from about  $\pounds 135$  to  $\pounds 185$ . The new deck has a nominal speed accuracy of 1% and a wow and flutter figure varying from 0.08% at 38 cm/sec to 0.2% at 4.75 cm/sec.

To reduce intermodulation distortion, f.e.t.s have been used in all low-level amplifier input stages resulting in a total distortion figure of 0.25% r.m.s. at output levels up to 10W. At the lowest tape speed the frequency response is 50Hz to 7kHz  $\pm 3$ dB, this improves to 30Hz to 20kHz  $\pm 2$ dB at the highest tape speed. The signal-to-noise ratio, unweighted and including hum, is better than 55dB and track separation on stereo models is approximately 45dB. To fully modulate the tape a signal at the microphone input should be greater than  $150 \mu V$  but less than 15mV into  $10 \text{ k}\Omega$  or more, the recommended source impedance lies between the limits 250 to  $2000 \Omega$ . The line input is  $2 \text{ M}\Omega$  and requires an input of between 75mV and 10V, in this case the source impedance is non-critical. The two  $6 \times 4$ -inch ( $15 \times 10$ cm) elliptical speakers incorporated are of course intended purely for monitoring purposes and the loudspeaker output socket provides up to 10W r.m.s. into speakers of 8-16  $\Omega$ . A low-level

output per channel is also provided and will deliver 300mV into a load of not less than  $10 \text{ k}\Omega$ .

Other features include variable speed rewind (max 1min./1200ft), recording level meters switchable to read bias with an easily accessible bias adjustment, tape/original switching through to output stages, three motors, remote control facilities, provision for fitting signal operated switching units etc. Ferrograph Co. Ltd., 84 Blackfriars Road, London S.E.1.

W.W. 328 for further details.

## "Free field" magnetic cartridge

By using a fixed magnet and a moving lightweight tube of magnetic material in their '800' stereo-mono pickup cartridge, Goldring have reduced the mechanical impedance of the moving system and so raised the resonance point to a frequency above 20kHz. Recommended tracking force is 1-3 grammes, but in a version with greater reduction of mechanical impedance, the '800/E', it can be down to  $\frac{1}{2}$  gramme. In the '800', which has a diamond stylus with a conical point, the effective tip mass is 1mg and the static compliance  $2 \text{ cm/N}$  ( $20 \times 10^{-6} \text{ cm/dyne}$ ). Sensitivity is  $1 \text{ mV/cm/s}$  and frequency range 20Hz to 20kHz. Separation does not fall below 15dB and averages over 20dB at

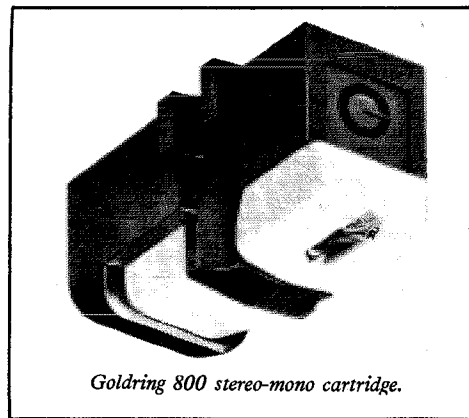

Goldring 800 stereo-mono cartridge.

middle frequencies. Performance of the '800/E', which has an elliptical diamond stylus, is somewhat higher. Both cartridges have Mumetal magnetic shields and removable styli. Goldring Manufacturing Co. (Great Britain) Ltd., 486-488 High Road, Leytonstone, London E.11.

W.W. 321 for further details.

## Semi-professional Recorder

The Philips semi-professional recorder PRO12 arrived in this country just in time to be shown at the Audio Festival. Unfortunately, full technical details of some of the more novel features did not. However, sufficient information has been gleaned to make a description worthwhile. The machine has two speeds, 19 and 9.5 cm/sec, which can be adjusted within 0.8% by the eddy current speed control system employed. This is used in conjunction with a built-in stroboscope. In order to achieve a smooth fast wind and to ensure the minimum of wow and flutter and mechanical noise during record and playback the left hand tape guide rotates during fast wind but is locked during other functions. To assist in maintenance the complete head block is removable. Wow and flutter depends on the speed selected but does not exceed 0.13% peak, fast wind time is less than 75 seconds per 1600m of long-play tape and the maximum spool diameter the machine will accommodate is 7 inches (18cm).

Normally the machine is supplied for two-track stereo or mono operation but four-track heads

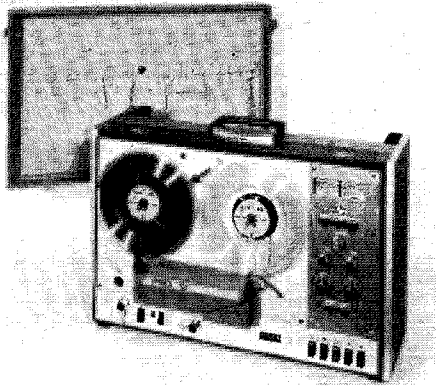

*Philips semi-professional recorder PRO12.*

can be supplied as an optional extra if required. The frequency response is to DIN45511 standard and is within 2.5dB from 60Hz to 18kHz (1.5dB from 60Hz to 12kHz) at 19 cm/sec in the playback mode only. The overall record/playback response increases the limits to 5 and 3dB. Signal-to-noise ratio, weighted and measured according to DIN45405 at 19 cm/sec is -56dB and cross talk rejection is better than 52dB. Crosstalk was measured at 1kHz (3% harmonic distortion) by recording one track at full level and h.f. bias on the second track. The second track is then replayed and measured. The record and playback amplifiers introduce less than 0.5% harmonic distortion. Three inputs per channel are provided as standard and two others may be included if required. They are (1) line, 100mV, 100k $\Omega$ , (2) microphones, 1mV (unbalanced) suitable for microphones from 50 to 200 $\Omega$ , (3) diode, 2mV, 20k $\Omega$ . The optional inputs are (4) microphone input with transformer (balanced) for 0.2mV—50 $\Omega$  and 0.4mV—200/500 $\Omega$ , and (5) transformer line input 0.775V, 10k $\Omega$ . Each channel has a 10k $\Omega$  line output with a nominal output voltage of 775mV, 4V max., in addition a line output transformer can be supplied providing a nominal 0dBm (6dBm peak) output. A stereo monitor output socket is also fitted and has the same characteristics as the standard line output. The single monitor amplifier provides 500mW into the internal speaker at 1% distortion. Twin Vu meters are employed and together with their associated amplifiers are within 2dB. These operate with a 0-10dB switch which is used for setting up purposes. Philips Electrical Ltd., Century House, Shaftesbury Avenue, London W.C.2.

**W.W. 317 for further details.**

## Philips Audio Plan

Three new units which now form part of the "Philips Audio Plan", the method by which a selection of basic units can be formed into a combination according to price or other requirements, are the stereo a.m./f.m. tuner GH944 and two stereo amplifiers GH943 (2 x 7W output) and GH949 (2 x 20W output). The GH944 covers the v.h.f., long-, medium-wave bands and short-wave bands from 16.48-50.8m. It has a built-in stereo decoder with automatic switching and stereo indicator. Audio response on f.m. is from 20Hz to 15kHz  $\pm$ 1.5dB with standard de-emphasis applied. Sensitivities are 6 $\mu$ V f.m. mono (60 $\mu$ V stereo) and 100 $\mu$ V on a.m.

Stereo amplifiers GH943 and GH949 are both designed to work into an 8- $\Omega$  load. The GH943 7W (continuous) model employs 10 transistors and diodes while the higher output model GH949 employs 22 transistors and diodes. Both are equipped with rumble and scratch filters, treble and bass tone controls, and inputs for pickup, tuner and tape. All units are for 110-240V, 50-60Hz, mains operation. Dimensions: 38 x 22 x 13cm (GH944), 34 x 21 x 14cm (GH943), and 34 x

27 x 14cm (GH949). Prices have not yet been announced. Philips Electrical Ltd., Century House, Shaftesbury Avenue, London W.C.2. W.W. 336 for further details.

## Five-unit Loudspeaker

Five drive units are used in the Ditton 25 loudspeaker system, introduced by Celestion, which is stated to be of studio monitoring quality. For the bass there is a 12-inch (30-cm) unit plus an auxiliary bass radiator of the type used in other Celestion speakers. For the higher ranges there are two mid-frequency pressure units and one high-frequency pressure unit. Frequency range is 20Hz to 40kHz and power handling capacity is 25 watts continuous (50 watts peak). Impedance is 4-8 ohms. Priced at £55 13s, the loudspeaker has an enclosure measuring 81 x 36

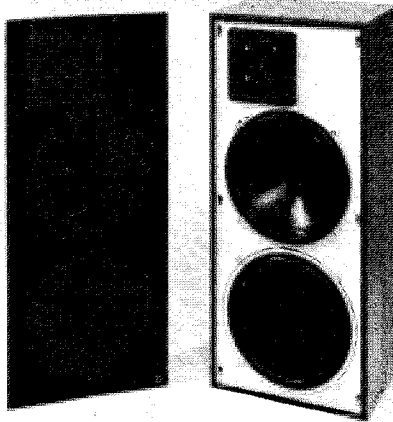

*Ditton 25 loudspeaker showing the five units.*

x 28cm with either teak or walnut finish. Rola Celestion Ltd., Thames Ditton, Surrey.

**W.W. 327 for further details.**

## Sinclair System 2000

A complete audio system was introduced and demonstrated at the Festival by Sinclair Radionics, comprising an f.m. tuner, a 35-W integrated stereo amplifier and a plinth-mounted circular loudspeaker. Measuring 30 x 15 x 5cm the f.m. tuner employs silicon transistors and features inter-station muting, fine tuning, a.f.c. and a pulse-counting discriminator. This type of discriminator has been found by the makers to provide better linearity and freedom from distortion than the ratio and Foster-Seeley discriminators. The tuner is available with or without stereo-decoder which can be plugged in to the mono version to convert to stereo when

*The f.m. tuner of the Sinclair 2000 system.*

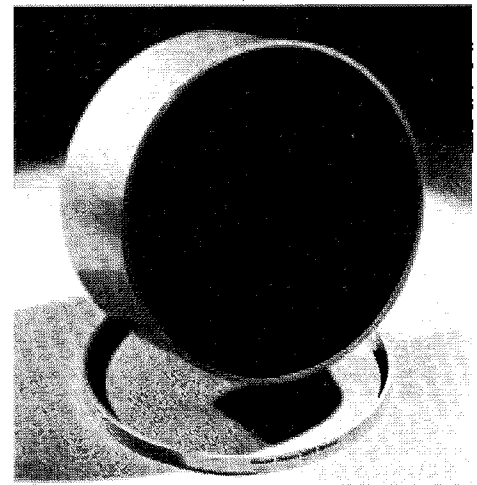
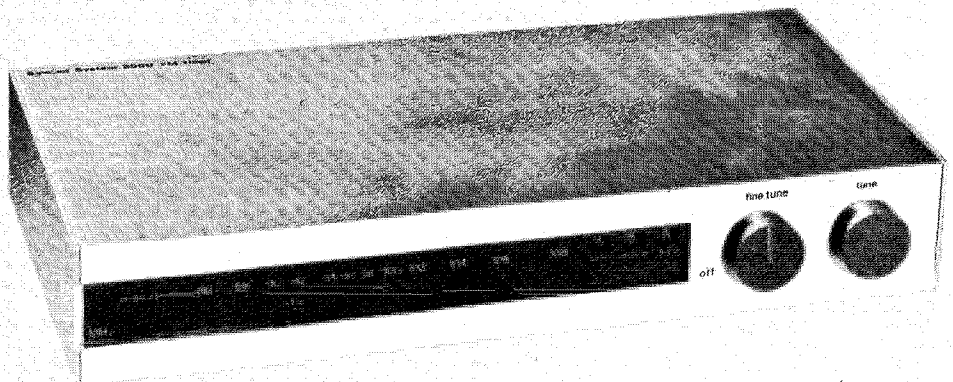

*Sinclair cylindrical loudspeaker.*

required. Stereo/mono switching is automatic and a stereo neon indicator is incorporated. The use of a variable capacitance diode makes remote tuning possible by means of a plug-in variable resistor, and a switched tuning module designed to fit the same socket will shortly become available. Frequency coverage is 86-108MHz and output 0.5V low impedance. Frequency response is quoted as 10Hz to 20kHz  $\pm$ 1dB. Built-in power supplies enable the tuner to operate from 200-250V, 50-60Hz a.c. The entire case and all controls are constructed from solid aluminium. Price 29gn. (25gn mono).

System 2000 amplifier also measures 30 x 15 x 5cm and is specified as having an output of 35W r.m.s. into a load of 3 to 15 $\Omega$ . The specification also includes total harmonic distortion <0.5% at 1kHz and full output power, frequency response 15Hz to 30kHz  $\pm$ 1dB at 1W and a damping factor of 50 at 1kHz. A transformerless circuit is used employing 12 silicon and 6 germanium transistors with 40dB negative feedback applied to the power amplifiers. Input facilities are fitted for the connection of pickups (magnetic and ceramic), tape (19 and 9.5cm/s), radio, microphone and auxiliary, with input selection by press-button. Price 29gn.

Housed in an aluminium cylinder and priced 12gn. the System 2000 loudspeaker introduced by Sinclair Radionics has a frequency response of  $\pm$  2dB from 100Hz to 15kHz and  $\pm$  5dB, 50Hz to 18kHz. Its power handling capacity is 10 watts continuous (20 watts music). The impedance is 8 ohms at 1kHz. The cylindrical enclosure has a diameter of 216mm (8 $\frac{1}{2}$ in) and depth of 102mm (4 $\frac{1}{2}$ in). Overall height of the speaker on its stand is 380mm (11in). Sinclair Radionics Ltd., 22 Newmarket Road, Cambridge.

**W.W. 320 for further details.**



## Recorder with F.E.T. Input Stages

Just introduced, the CBL/7T retains a distinct similarity, appearance wise, to earlier Vortexion recorders. The black case is retained and the amplifiers for each channel are mounted either side of the tape deck as was the previous practice. The mechanical performance is identical to that of the Ferrograph as both employ the same model seven tape transport by Wright and Weaire, wow and flutter less than 0.1%, 8.25 inch spools (with lid closed), spool height and adjustment, three speeds and provision for remote control.

Eight f.e.t.s are employed in amplifier input stages operating under "starved input" conditions in order to reduce intermodulation distortion to a minimum (0.1% at 10W). These input stages are individually mumetal shielded and are then further shielded by a steel screen to achieve the 58dB signal noise ratio. The f.e.t.s employed are SGS-Fairchild types with 0.1dB noise figure.

The complementary symmetry power amplifiers provide 10W r.m.s. per channel output and employ a similar overload protection circuit to that described by Dr. Bailey elsewhere in this issue. The amplifiers are not new, however, as they have been used in other Vortexion equipment over the past two years and are therefore proven from the reliability point of view. The tone control circuit employed is a modified Baxandall arrangement which provides up to 13dB bass and treble lift and cut. This allows for reasonable tonal balancing at the lower output levels.

The low impedance microphone inputs are matched to the high input impedance of the f.e.t. first amplifier stages in mumetal screened transformers, 40-50 $\mu$ V is required at this input to fully modulate the tape. The line input has an impedance of 100k $\Omega$  and requires 40mV running into overload at about the 1V input level.

At a tape speed of 19cm/sec the overall fre-

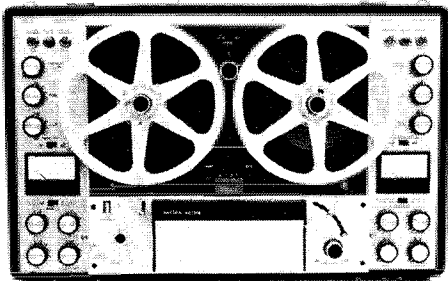

Vortexion CBL/7T tape recorder.

quency response is within  $\pm 2$ dB from 30Hz to 18kHz, however, the makers say that this is conservative and would typically be within  $\pm 1$ dB.

Other features of the recorder, which costs £189, include separate speaker volume control so that the monitoring level can be adjusted independently of record level, "before and after" monitoring, bias measuring facility, cross mixing of channels and an echo facility. Vortexion Ltd., 257/263 The Broadway, London S.W.19.

W.W. 329 for further details

## Kirksaeter Products

Although this German company has been exporting to Common Market countries for a number of years it is a new name in the British hi-fi market and one which appeared at the Audio Festival for the first time this year. Their demonstrations highlighted in particular various versions of integrated tuner/amplifiers. In these the collectors of the Class B output transistors are connected in a bridge circuit which results in a very low internal resistance so that the output is not significantly affected by different speaker impedances. The units are fitted with one loudspeaker

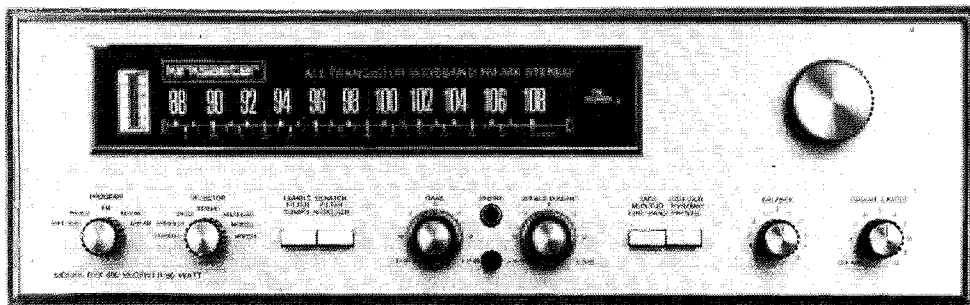

Kirksaeter RTX400 stereo f.m. receiver-amplifier.

output only to which it is permissible to connect a speaker of any impedance between 4 $\Omega$  and 6 $\Omega$ . The RTX400 employs 44 silicon transistors and 16 diodes and provides a sine wave output of 65W. Radio covers the f.m. (87.5-108.5MHz) band only with automatic mono/stereo switching. Inputs are provided for both German (DIN) and U.S.-type sockets and a rumble filter or scratch filter can be switched-in by press-buttons. Model RTX700 has a similar specification to the RTX400 except that the power output is higher at 100W sine wave. U.K. Agents: A.C. Farnell Ltd., 81 Kirkstall Road, Leeds 3, Yorkshire.

W.W. 338 for further details.

## Two-unit microphone

A narrow, cylindrical moving-coil microphone which looks more like a capacitor microphone is the D224 from A.K.G. (shown by Politechna). This microphone, which has a cardioid characteristic, contains two capsules, one for the high-frequency part of the range and one for the low-frequency part, and a cross-over network. In this respect it is similar to the earlier D202 which was introduced last year (see W.W. April 1968, p. 59, for explanation of principle). It has a frequency range of 20Hz to 18kHz, a sensitivity of -77dB relative to 10V/N/m<sup>2</sup> (0.15V/ $\mu$ b) and an impedance of 200 ohms at 1kHz. Politechna (London) Ltd., Eardly House, 182/4 Campden Hill Road, Kensington, London W.8.

W.W. 322 for further details.

## Record Reproducer Plinth

For housing their pickup arms, and various makes of turntables, S.M.E. have introduced a record reproducer plinth constructed in rose-wood with a one-piece acrylic lid. It features a four-point spring suspension system with adjustable damping which carries the motor board and protects it from acoustic feedback and external vibration. A range of interchangeable motor boards will be available, ready cut and drilled to accept various combinations of arms and turntables. Price is £25 4s. S.M.E. Ltd., Steyning, Sussex.

W.W. 325 for further details.

S.M.E. record reproducer plinth with acrylic lid.



## Belt-driven turntable

A flexible belt-driven system is used to reduce vibration and transmission noise in the Connoisseur BD1 turntable, which is intended for high-quality sound reproduction but has a relatively low price (£13 19s 2d). The turntable proper is a 26cm (10 $\frac{1}{2}$ in) diameter lathe-turned aluminium casting with a phosphor bronze bearing. Drive is from a slow speed synchronous

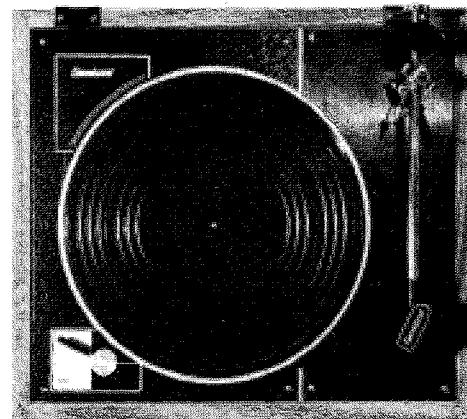

Connoisseur turntable and pickup.

motor. The speed required (33 $\frac{1}{3}$  or 45 r.p.m.) is selected by lifting a hinged metal cover and moving the ground rubber cord drive belt. Rumble is -60dB and hum -80dB relative to 7cm/s at 1kHz. Wow and flutter are approximately 0.1 of 1%. The turntable is available in chassis form or on a plinth with a pickup mounted. A. R. Sugden & Co. (Engineers) Ltd., Market Street, Brighouse, Yorks.

W.W. 340 for further details.

## Kit Tape Recorder

Designed to satisfy the needs of those who prefer to build their own equipment this particular member of the Daystrom kit-family has three speeds, four tracks and incorporates a total of eighteen transistors. The BSR TD10 tape deck supplied with the kit will accommodate up to seven-inch spools, incorporates a digital tape position counter and at the highest speed (19cm/sec) the wow and flutter figure is 0.15%. Power amplifiers provide 4W r.m.s. per channel into the two internal 8 x 5 inch (20 x 13cm) loud-speakers; unweighted signal-to-noise ratio is better than 40dB. Again at the highest speed, the frequency response is within  $\pm 3$ dB from 40Hz to 18kHz and at the lowest speed (4.5 cm/sec) the upper 3dB limit falls to 7.5kHz. Two inputs are provided per channel and are: microphone, requiring 350 $\mu$ V into 50k $\Omega$ ; and auxiliary, needing 50mV into 80k $\Omega$ . Likewise two outputs per channel are provided, 4W into 15 $\Omega$  and 250mV from 4k $\Omega$ . The recorder, which costs £58 in kit form or £70 assembled, comes complete with a moving coil microphone, 5.75 inch (15cm) reel of

tape and the sort of comprehensive instruction manual for which Heathkit have become well-known. Daystrom Ltd., Bristol Road, Gloucester. W.W. 315 for further details.

## Truvox Series 200

The six models that comprise the 200 range of tape recorders consist of two- and four-track stereo and mono machines available in a choice of p.v.c. or teak cases.

The tape deck used is the same on all machines and has seven-inch (18cm) reel capacity, three speeds, 19, 9.5 and 4.75 cm/s with a wow and flutter content of 0.25% for the lowest speed and 0.1% for the highest. It incorporates three motors, has a rewind time for 1200ft of 2 min and has an outside rotor capstan motor. All four-track models have an unweighted signal-to-noise ratio of 48dB and the two-track models 50dB. The frequency response is the same in each model and is 30Hz to 18kHz  $\pm$  3dB at 19cm/sec and 40Hz to 7kHz  $\pm$  3dB at 4.75cm/sec. Two inputs per channel are provided, the low-level microphone input requires not less than 1mV into 50k $\Omega$  and the line input needs 50mV into 200k $\Omega$ .

Mono versions cost in the region of £125 and include a 10-W output stage and an 8 x 5 inch (20 x 13cm) hyperbolic cone loudspeaker. A semi-cardioid moving-coil microphone is also sup-

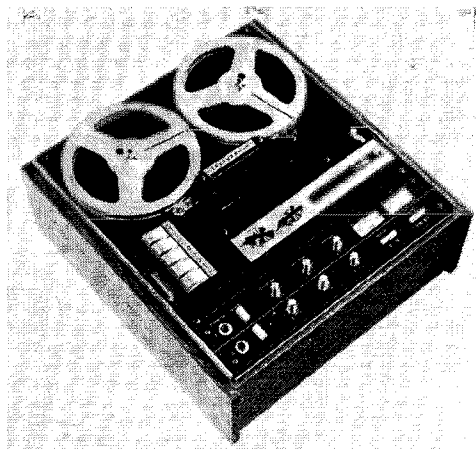

One of the Truvox "200" tape recorders.

plied. Stereo versions are intended for building into a system so do not incorporate output stages or loudspeakers. These cost about £150. Truvox Ltd., Shore Road, Hythe, Southampton. W.W. 313 for further details.

## Braun Stereo Amplifiers

Two new Braun stereo amplifiers were demonstrated by Fi-Cord International, both types being fully transistored. The CVS250 is a 2 x 15W (continuous) amplifier which is matched in design and colour scheme to the Braun CE500 tuner. It is equipped with a volume control with push-pull switch for by-passing loudness compensation, separate bass and treble controls for each channel and a stereo/mono switch. Frequency response is said to be 30Hz to 30kHz and distortion < 0.5% at 12W. Inputs are provided for radio, gram, tape and reserve, and outputs for two 4- $\Omega$  impedance loudspeakers. Dimensions: 26 x 11 x 32cm. Model CSV500 is a combined pre-amplifier and power amplifier with switchable rumble filters, treble filters and presence boosting. It has a power output of 2 x 45W (continuous) for 4- $\Omega$  loudspeakers and slightly less power when connected to 8 $\Omega$  loudspeakers. Distortion is given as 0.5% (4 $\Omega$ ) or 0.3% (8 $\Omega$ ). Separate bass and treble controls are provided for each channel. Frequency response is quoted as 10Hz to 35kHz. Five inputs are provided for gram,

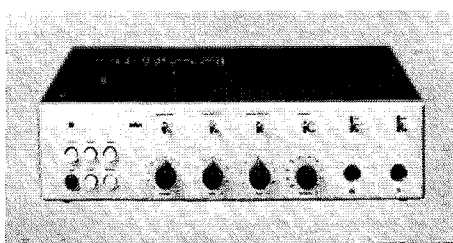

Braun CSV500 stereo amplifier and pre-amplifier.

tape, radio, microphone and reserve, and outputs for loudspeakers of 4-16 $\Omega$  and headphones of 400 $\Omega$  impedance. Dimensions: 40 x 11 x 32cm. Prices: CSV250, £103.5s.; CSV500, £203.10s. U.K. agents Fi-Cord International, Charlwoods Road, East Grinstead, Sussex. W.W. 331 for further details.

## Loudspeaker kit

At a price of £10.10s Rank Wharfedale have introduced a high-fidelity loudspeaker kit containing an 8-inch (20-cm) bass/middle-range unit, a pressure unit for the treble, a cross-over network, connecting wire, mounting bolts and acoustic wadding. The 8-inch unit has a magnet with a field strength of  $9.6 \times 10^5$  A/m (12,000 oersteds), flux of  $4.8 \times 10^{-4}$  weber (48,000 maxwells), a die-cast chassis and a flexible roll surround. Its free air resonance is 35Hz. The pressure unit has a magnet field strength of  $8.4 \times 10^5$  A/m (10,500 oersteds) and has a dome diaphragm with a diffuser cap. Frequency range is 40Hz-17kHz and the cross-over frequency is 1,750Hz. Power handling capacity of the whole system is 15 watts and impedance 4-8 ohms. Cabinets (parts not supplied) can be any size between a minimum 356 x 248 x 223mm (bass restricted to 65Hz) and a maximum 293 x 560 x 242mm. Rank Wharfedale Ltd., Idle, Bradford, Yorks.

W.W. 319 for further details.

## Record Cleaning Machine

Intended for use by public libraries, record dealers, broadcasting organizations etc., a disc record cleaning machine introduced by Audio & Design comprises a turntable, a liquid application system and a suction cleaning mechanism. The turntable carrying the record revolves at high speed and a liquid solvent is applied by swinging a brush over and down onto the record. Considerable pressure can be applied since the disc is well lubricated by the liquid. This action dissolves grease and loosens grit on the record. Next a suction arm is moved to the centre of the disc. It is held by suction to the surface, and a tracking mechanism moves it outwards towards the periphery of the revolving record. This removes the liquid with its dissolved and suspended foreign matter and leaves the record dry and free of chemicals. The whole process takes about two minutes per side. Audio & Design (Recordings) Ltd., Special Products Division, 40 Queen Street, Maidenhead, Berks.

W.W. 324 for further details.

## Fisher Hi-Fi F.M. Receivers

A new item added to the well-known American Fisher range seen at the Audio Fair was a high-quality f.m. receiver with pre-set press button tuning. This tuning arrangement is one which has appeared for some time on a number of German f.m. tuners and a Fisher representative explained that a German-made tuning device was, in fact, incorporated in the design. Fisher call

their device "Tune-O-Matic" and it comprises five tuning knobs, each knob having its associated vertical frequency scale and a cursor on the receiver fascia. Each knob can be tuned to a different f.m. station and pre-set, so that subsequent changing from one station to another only requires the appropriate tuning button to be depressed. Stations can also be tuned manually if desired. The receiver, model 160-T, provides r.m.s. power of 15W per channel at 1kHz with 0.5% harmonic distortion. Audio bandwidth is 25Hz to 25kHz. Usable sensitivity of the tuner section is 2.2 $\mu$ V and signal-to-noise ratio at 100% modulation and 1mV input is 60dB. The design incorporates i.c.s, f.c.t.s and a silicon-transistor complementary output stage

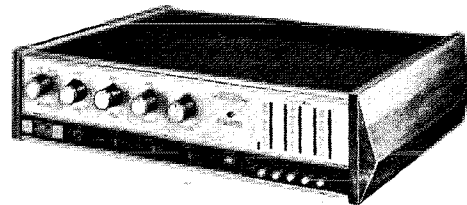

Fisher 160-T 40-watt f.m. stereo receiver.

with short circuit protection. The presence of a stereo broadcast automatically switches the decoder to stereo and operates the indicator lamp. Tone controls are of the Baxandall design. Dimensions are 39 x 8 x 29 cm; weight 6.8kg and power consumption 65W. Price: 129gn. U.K. Distributors: Getz Bros. & Co. Inc., 2 Harewood Place, London W.1.

W.W. 332 for further details.

## Noise cancelling microphone

The type 4-70 noise cancelling ribbon microphone just introduced by Lustraphone uses two ribbons, inclined towards each other like the sides of a 'V' and connected in antiphase. When the direction of the sound waves is such that they enter symmetrically between the two ribbons (into the top of the 'V') the ribbons move in opposite directions, and because they are connected in antiphase their signals are additive. Sound waves arriving at either side of the 'V', however, cause both ribbons to move in the same direction, and in this case the two electrical signals are subtractive.

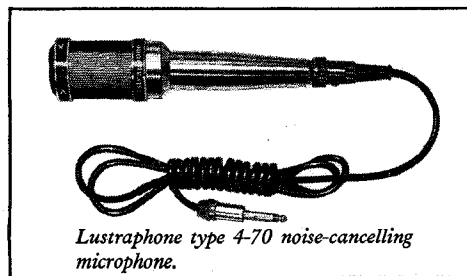

Lustraphone type 4-70 noise-cancelling microphone.

This results in an acceptance angle of about 50° for wanted sounds, while unwanted sounds—those arriving from all other directions outside this acceptance angle—produce very weak signals. Price of the 4-70 microphone is £26.5s. Lustraphone Ltd., St. George's Works, Regents Park Road, London N.W.1.

W.W. 323 for further details.

## Sansui Control Amplifier

One of the exhibits from Japan was a solid-state combined stereo control and power amplifier, model AU-777 by Sansui. This unit has a continuous power output rating of 2 x 30W and a sensitivity of 2mV for rated output. Harmonic distortion is < 0.5% and power bandwidth (i.h.f.)

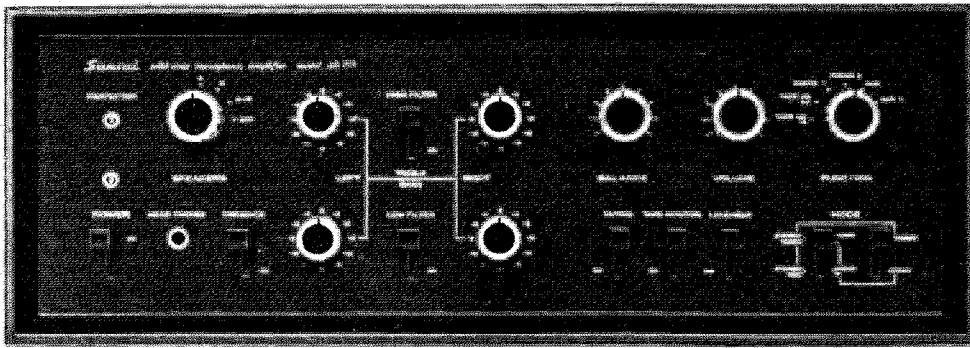

Sansui AU-777 control amplifier with a continuous output of 25W per channel.

is 20Hz to 50kHz. Frequency response of the main amplifier is given as 20Hz to 100kHz  $\pm 1$ dB at normal listening level. Dual concentric negative feedback type tone controls give treble and bass lift and attenuation of 15dB. The pre-amplifier and main amplifier sections are designed so that they can be used separately in conjunction with other equipment. A total complement of 26 transistors and 13 diodes is used in a transformerless circuit with protection against accidental short-circuits. Four outputs and seven inputs provide the AU-777 with all the necessary inputs and outputs for an amplifier: pre-amp, tape, and two centre channel outputs, two gram inputs, tape and auxiliary inputs. The centre channel outputs are two terminals for connection to a third mono amplifier which is said to give a three-dimensional effect. The full control range includes a loudness control and presence switch, also a speaker selection switch. Price 105gn. U.K. Agents: Technical Ceramics Ltd., Cheney Manor Industrial Estate, Swindon, Wiltshire.

W.W. 337 for further details.

### Rogers F.M. Tuner

Provisional details were available at the Audio Fair of a new f.m. tuner unit being displayed by Rogers Developments which they call the Ravensbourne 2. Although designed for use with the Ravensbourne stereo amplifier, it is suitable for use with many other amplifiers. The Ravensbourne 2 is an example of a product designed primarily for export, but which is recommended for use in this country where reception conditions are particularly difficult. It has high sensitivity ( $3\mu\text{V}$  for full limiting) and high selectivity, but adequate bandwidth for stereo reception. Three f.e.t.s are featured in a four-gang front end followed by six silicon and one germanium type. An optional decoder contains a further seven silicon transistors. Audio output is 150mV r.m.s. average (mono) and 200mV r.m.s. average (stereo). Four different prices are quoted for the tuner according to whether it is supplied with or without decoder and case. The top price for a complete stereo model with case is £63 10s and its dimensions are 32 x 29 x 13cm. Rogers Developments (Electronics) Ltd., 4-14 Barneston Road, Catford, London S.E.6.

W.W. 339 for further details.

Ravensbourne 2 f.m. tuner (Rogers).



### Arena Tuner/Amplifier

Made by Hede-Nielsen Fabriker, of Denmark, the Arena products stand included tuner/amplifier model T1500F which became available in May. This is a stereo a.m./f.m. tuner combined with power amplifiers which provide 6W output per channel. 87-104MHz is covered on the f.m. range, and on a.m. a s.w. band covers 40-51m plus the usual medium- and long-wave broadcast bands. Sensitivity on f.m. is  $1\mu\text{V}$  and on a.m.  $10\mu\text{V}$ . Socket facilities provide for up to four 4- $\Omega$  impedance loudspeakers, magnetic (6.5mV at 50k $\Omega$ ) and crystal (450mV at 5M $\Omega$ ) pickups, and tape recorder input and output. Separate bass and treble combined tone controls give  $\pm 15$ dB and  $\pm 10$ dB variation respectively. Frequency response is claimed to be 20Hz-18kHz and harmonic distortion 0.15% at 5W. The T1500F measures 15 x 42 x 21cm and employs 20 transistors and 20 diodes. Special features include an automatic f.m. scanning system and preselection of five f.m. stations. Price 61gn. Arena products are distributed in the U.K. by Highgate Acoustics, 184-188 Great Portland Street, London W.1.

W.W. 330 for further details

## Books Received

**F.E.T. Applications Handbook** edited by Jerome Eimbinder. Introductory chapters look at the various types of f.e.t. that are available, discussing their electrical characteristics and applications. Two chapters are devoted to biasing problems and techniques and a further chapter concentrates on the device as a constant current source. Oscillators, noise, audio amplifiers and pre-amplifiers, v.h.f. pre-amplifiers, source followers, phase splitters and drive circuits occupy a further seven chapters. The f.e.t. as a switch forms the subject heading under which the majority of the remainder of the book falls and the f.e.t.'s use in chopper, integrated and commutating circuits is described as are serial logic arrays. The final chapter is concerned with the photo-f.e.t. Pp 286. Price \$12.95. Tab Books, Blue Ridge Summit, Pa7214, U.S.A.

**F.E.T. Circuits** by Rufus P. Turner contains a wide range of practical circuits. Some difficulty may be experienced by the English reader because of the American terminology used, however, as with other books from this publisher, a section is included to assist the English, and this together with a little common sense should surmount any problems which may occur. The first chapter is devoted to the construction, operation and performance of the f.e.t. Constructional projects are under six headings: amplifiers, oscillators, receivers, transmitters, control and instrument circuits. The amplifier section includes circuits for a variety of audio amplifiers, and an audio notch filter, and proceeds up the frequency spectrum through i.f. to video amplifiers. The oscillators described simi-

larly cover the frequency range from audio to r.f. The transmitter section includes a number of designs but the English reader should tread with caution in view of the difference in licence regulations between here and America, a subject which is discussed in the advice to English readers' section. Control circuits cover the usual range of devices in the electronic novelty category: timers, sound operated relay, etc. The instrument section describes about twenty assorted electronic test instruments. Pp 160. Price 26s. W. Foulsham & Co. Ltd., Slough, Bucks.

**Transistor Audio Amplifiers** by S. J. Hellings, from the Philips Technical Library, is roughly split into two sections; the first covering transistor theory and the second amplifier design. The transistor theory starts with the necessary basic description of the structure of matter and proceeds to the relationships between the *h*-parameters and transistor properties. The remainder of the book (21 chapters) is devoted to amplifier design problems—feedback, temperature, frequency limitations, interstage coupling, tone control, equalization, noise, etc. Several complete amplifier circuits are given together with complete design information. Pp 333. Price 104s. Macmillan & Co. Ltd., Little Essex Street, London W.C.2.

**Practical Television Circuits** by R. E. F. Street. There are enough circuits in this book to keep the most industrious constructor going for years. Constructional information is given on five aerial pre-amplifiers, the Olympic II transistor 14-inch television receiver (405 lines only), a TV hearing aid and a baby alarm, interference suppression circuits, TV and converter and test equipment—oscilloscope, wobulator, Q-meter, e.h.t. voltmeter, signal strength meter, etc. Pp 375. Price 30s. Newnes Books, Hamlyn House, 42 The Centre, Feltham, Middlesex.

**Fundamentals of Digital Magnetic Tape Units** by the Field Engineering Department, Univac Data Processing Division, of the Sperry Rand Corporation. The book should be of value to those schools and individuals who are at the present time employed on a computer project and wish to extend this to embrace magnetic tape storage. Two early chapters look at the various aspects of electricity and magnetism as they apply to tape recording in general and digital tape recording in particular. Twenty pages are devoted to tape transport mechanisms which discuss the various pinch roller, plus vacuum, tape handling methods in use. The recording techniques chapter describes the various ways that are employed to record binary information together with data recovery and error detecting techniques. The last chapter deals with circuits, both read and write, but they are not complete in that head impedances and semiconductor types are not given. Pp 96. Price 21s. W. Foulsham & Co. Ltd., Slough, Bucks.

**Semiconductors Vol III—Non-linear circuits** by E. J. Cassagnol (from the Philips Technical Library). The first part of this volume deals with oscillators, the initial chapter outlining the study methods involved. The oscillator section is split into two, one part covering the harmonic oscillators (phase-shift, tuned circuit, resonator-crystal-tuning fork, etc., bridge oscillators) and the second part relaxation oscillators (various types of multivibrators). Sandwiched between these two is a chapter on various aspects of RC circuits. Thirty pages are devoted to scanning circuits with detailed discussions on the various integration methods that may be employed. The digital circuits chapter includes a summary of Boolean algebra and elementary logic functions and discusses transistor and diode logic circuits, magnetic circuits and binary elements. The remainder of this book concentrates on power supplies. Pp 265. Price 108s. Macmillan & Co. Ltd., Little Essex Street, London, W.C.2.

# Television Camera Tubes

## Recent developments in the image orthicon

by I. R. Sinclair, B.Sc., M.I.E.E.

In the years after the war, the image orthicon became firmly established as the only television camera tube suitable for a wide range of high-quality transmissions. The hope that the small and comparatively inexpensive vidicon, using a photoconductive layer of antimony trisulphide, would replace the image orthicon, has not been realized. The improved form of vidicon known as the Plumbicon\* (devised by the Philips Company, and using a lead oxide layer formed by evaporation of lead oxide in argon gas) has proved a much more likely successor. Its smaller size, its comparative simplicity from the user's point of view, and its good performance make it preferable to the i.o. in many respects, and in colour cameras the problems of obtaining registration from three Plumbicons are much less than the corresponding problems with image orthicons. Nevertheless, to utilize the full resolution capabilities of a colour signal on 625 lines (remembering that the monochrome signal has a much greater bandwidth than the chrominance signals, and is responsible for the impression of resolution seen by the eye) it is preferable to use a 4½-inch i.o. to provide the monochrome signal, and Plumbicons (two or three) for the chrominance signals.

Eventually, the lead oxide tube will probably replace the i.o. completely, but, at the moment its development seems to have slowed down somewhat, while recent work indicates that the full performance of the i.o. has not yet been realized. Economic considerations may also delay the displacement of the i.o. by the Plumbicon; neither form of

tube is inexpensive, but the replacement of large numbers of cameras and lenses is not a process which is likely to be hurried. When the 4½-inch i.o. was introduced, it was intended that this technical advance on the 3-inch tube would eventually make the latter obsolete. This has not happened; the lower price of the 3-inch i.o. and its associated equipment has, in fact, until recently caused a steady expansion in the sales of this tube size.

In North America, of course, many commercial stations are run on a budget which allows very little for maintenance or replacement of equipment; similar economic considerations also apply to several European countries. Another factor which has prolonged the life of the 3-inch i.o. in America is the alleged low quality of the picture on domestic receivers; one engineer once remarked that they could get away with a thirty-line system if the wording on the commercials were made slightly bigger!

### Operation of the Tube

The tube can be divided, for the sake of understanding its operation, into three sections (see Fig. 1); the image section, dealing with the conversion of the light image into an electron image and the storage of that image in the form of a charge pattern on a dielectric; the scanning section, forming the electron beam which scans the charge pattern and forms a modulated return beam; and the multiplier section, which noiselessly amplifies the modulated return beam to the usable proportions of an output signal at the final anode.

The image section comprises the photocathode (a thin layer of photo-emissive material prepared *in situ* during the evacuation of the tube), the image accelerator electrode, and the target cup, to which is attached the target and target mesh assembly. When the photocathode, to which an electrical contact is made, is illuminated and made a few hundred volts negative to the other electrodes, electrons leave it in quantities proportional to the strength of the light. The light image formed by the lens on the photocathode has now become an 'electron flow' image, and must be focused by the image accelerator electrode and by an externally applied solenoidal magnetic field to prevent deterioration and to ensure that the size of

the electron image matches the size of the target. In the older 3-inch tube, a reduction in size was necessary; in the later 4½-inch version the image is magnified; in each case this is accomplished by grading the strength of the applied magnetic fields. Modern cameras use additional faceplate coils to improve the geometry of the image section, high (negative) photocathode voltages are also used to minimize chromatic aberration caused by the different initial speeds of electron emission.

The electron flow image is converted to a stored charge image at the target—a thin sheet of dielectric material with a small but important amount of conductivity from front to back. Electrons landing on this target, conventionally made of 0.0001-inch thick soda-glass, charge the surface facing the photocathode *positively* by secondary emission (each landing electron knocks off more than one existing electron, so the net result is loss of electrons which amounts to a positive charge) as long as the secondary electrons released by this process can be collected at a surface more positive than that of the target face. This more positive surface is provided by the metal target mesh, located about 0.001-inch in front of the target. Besides acting as a collector of secondary electrons, the target mesh serves two other functions. There exists a capacitance between the mesh and the surface of the target (the assembly is in effect a parallel plate capacitor) and it is this capacitance which is used to store charge. The presence of the target mesh also helps to ensure that electrons arriving from the photocathode arrive normal to the target, and not at random oblique angles.

Due to the conductivity of the target, an image of potential appears also on the side facing away from the photocathode, and it is this image which is scanned by the electron beam in the scanning section. The beam, derived from a cathode and grid similar to those used in a c.r.t., is limited in diameter by passing through an aperture of diameter 0.001-0.0025-inch, and is focused electrostatically and magnetically. Electromagnetic scanning is used, and bucking coils are employed in modern cameras to ensure that the scanning field does not extend into the region of the target. In addition, two sets of coils (the alignment coils) whose axes are perpendicular to each other and to the tube's axis, are used to ensure that the beam

\* Registered trade mark of N. V. Philips' Gloeilampenfabrieken of Eindhoven, Holland.



After graduating from St. Andrews University, I. R. Sinclair joined English Electric Valve Co. in 1956 as a junior engineer working on direct-view storage tubes. He later transferred to the television camera tube department where he stayed until 1966 when he joined the staff at the Hornchurch College of Further Education. He is now a lecturer in physics and physical chemistry at the Braintree (Essex) College of Further Education.

approaches the target along lines perpendicular to the target surface. The operating characteristics of the image orthicon are greatly improved if another mesh, the field mesh, is placed between the target and the electron gun at a distance of about 0.25-inch from the target. This has the effect of altering the decelerating field at the target (the mesh is run some ten volts positive to the G4 of the electron gun) and the visible effect is a considerable improvement in black-white transitions, which are very much sharper when a tube incorporating a field-mesh is used.

The target potential at any point is set by the stored charge which in turn is derived from the photocurrent at the corresponding point on the photocathode. The maximum positive excursion of the target potential is set by the voltage applied to the target mesh because secondary electrons can leave the target only if a more positive potential exists in a region which is not co-planar; when a region of the target has the same potential as the target mesh there is no tendency for electrons to travel from one to the other. The minimum potential of the target is set by the beam striking the target—this is equivalent to connecting the target to cathode, and so the minimum target potential is cathode potential. For the best rendering of grey tones by the image orthicon, the target mesh is usually set at 3 volts positive to cathode potential.

As the beam scans the target, varying fractions of the beam current land on the target according to the potential pattern on it. The remaining fraction of the beam is reflected specularly to form a return beam moving back down the scanning section; this return beam is a larger fraction of the incident beam while a portion of target at cathode potential is being scanned, and a smaller fraction of the incident beam during the scan of a region of maximum positive potential. The return beam current is therefore the inverse of the original photocurrent. The forward beam current and the time constant of the target (the product of the through resistance of a unit area and its capacitance to the target mesh) together determine the fraction of the charge at each scan and hence the storage time—the time for which an image is visible after photocurrent to the target has ceased. Since the conductivity of the target varies with tempe-

perature, the storage time of an image orthicon is very long when the tube is cold (a phenomenon known as sticking) and short when the tube is hot (causing some loss of sensitivity). In modern cameras, the temperature of the target section of the tube is thermostatically controlled.

The function of the multiplier section is to amplify the return beam signal by a series of secondary emitting stages, or dynodes. As in the case of every amplifier, the first stage is the most important. If the forward beam always travelled exactly perpendicular to the target, the return beam should be the exact inverse of the forward beam. As the angle of incidence varies slightly during scanning, the angle of return also varies, and the effect is that the return beam scans the first dynode. Because of this, any variation of the secondary emission ratio of the first dynode over its scanned area must cause variations in the output signal which superimpose a 'picture' of the first dynode surface on the received picture.

### Modern Developments

**The Target.**—Since the target is the processing element which converts the weak continuous signal from the photocathode into a stronger intermittent (scanned) signal, it is not surprising that a considerable amount of development work has been carried out on this section. Conventionally, the target is made of soda-glass blown into a bubble. A suitable portion of the bubble is selected and sealed onto a metal ring, the rest of the bubble being broken off. A later development is to use two semicircular loops of wire which are electrically heated, coated with glass, and then separated by rotating one loop about the common axis. In this way a circular film of glass is produced, and can be sealed to a metal ring in the same way as before. This method is particularly useful in making the types of glass target referred to later which must be prepared in a non-oxidizing atmosphere.

General Electric of the U.S.A. has pioneered the use of targets of magnesium oxide. This material has a high secondary emission ratio, which has the effect of increasing the sensitivity of the tube, but the resistivity is also very high, which makes it necessary to use very thin films of the material. Although the technology of prepar-

ing thin films of refractory materials is adequate, means of supporting such films are not, and target vibration is even more of a problem than it is with glass targets. Despite this, the life of tubes using magnesium oxide targets is claimed to be very long, the response is linear, and the warm-up time negligible.

These benefits derive from the different conduction mechanisms of glass and magnesium oxide, the former conducting by the movement of sodium ions (since glass is a 'fossilized' liquid, not a solid) and the latter by movement of electrons. Ions are large particles, and their movement in one direction through a glass target depletes one side and enriches the other; there is no mechanism for reversing this process short of melting the glass to permit the ions to move back freely. The consequences of this process are that the resistivity of the target rises steadily during the life of the tube, increasing the time constant of the tube until it is unsuitable for anything but still pictures. The transfer of ions can also take place to such an extent when the camera is left on a stationary scene that the charge image of the scene is permanently 'printed' on the target. These effects limit the life of a tube using the conventional glass target, and the use of electronically-conducting magnesium oxide has shown that image orthicons with very long working lives can be made once this barrier is removed.

Another approach to the desired electronic conduction exists by making glass containing a high proportion of titanium oxide, along with other oxides of the same chemical group. Because these oxides can exist in either of two stable chemical conditions, one being electron deficient, electronic conduction can take place in a glass made of such oxides. This approach preserves the traditional type of material, but imposes severe manufacturing problems, since the glass cannot be worked in the presence of even a minute quantity of air. Targets made from this electronically conducting glass exhibit the same desirable long-life properties as those made from magnesium oxide; and are mechanically more robust.

A third form of target material which is under intensive investigation is the secondary electron conduction (s.e.c.) target. Secondary emitting targets made from aluminium oxide coated with aluminium and with potassium chloride have been known for some time, and are used in light amplifiers as transmission multipliers, that is, multipliers where the secondary electrons emerge travelling in the same direction as the primary electrons causing them. Research by the Westinghouse Co. of the U.S.A. has shown that a small modification to the process of depositing the potassium chloride layer (evaporation in an atmosphere of dry argon) results in a spongy layer with an extremely high secondary emission ratio. Secondary emission ratios of 50-400 seem likely if production difficulties can be overcome; the main difficulty in the use of such targets is that moisture must be totally excluded during their handling. To comply with such a requirement means that the design of an image orthicon must be considerably changed, no conventional glass seal-

Fig. 1. Sectional diagram showing the disposition of the image, scanning and multiplier sections of an image orthicon

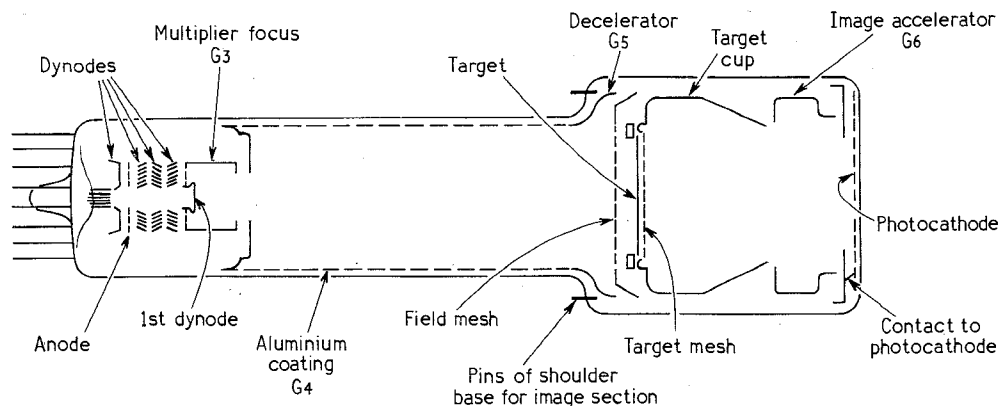

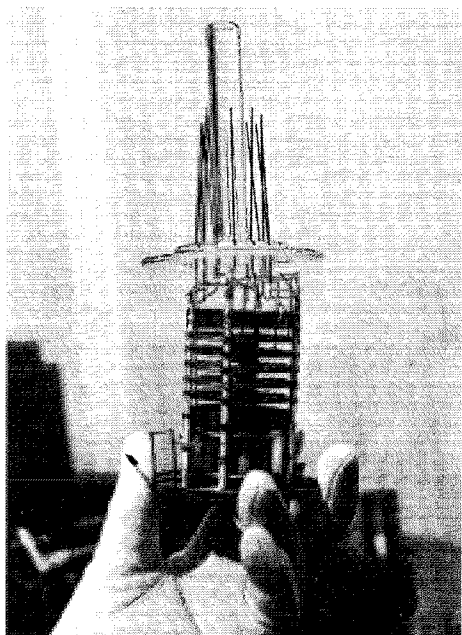

*Electrode assembly of a 4½-inch E.M.I. image orthicon television camera tube showing the multiplier and dynodes.*

ing operation must, for example, be carried out after target insertion, limiting constructional methods to solder-glass joints or argon-arc welding. With the tube filled with dry argon, the former is unsatisfactory because it requires heating the whole tube; the latter requires considerable redesign of the tube in the target region, though such a redesign would offer an excellent opportunity for rationalizing the design of the target mountings and incorporating improvements in the image section geometry.

Apart from the use of new target materials, the growing problem of target microphony has promoted a large amount of research on the mechanical nature of the processes at the target. Two types of target microphony have been identified; shock microphony, caused by vibration, whether mechanical (in tracking or handling) or acoustical (especially with percussive sounds); and electrical microphony, caused by magnetostriction in the material in which the target is mounted, which starts and stops in random fashion irrespective of the presence or absence of vibration. Any form of microphony is most undesirable in a camera tube, since it is readily visible on domestic receivers, whereas most other forms of signal degeneration (with the exception of sticking) are not.

Both forms of microphony are greatly aggravated by the use of high (3V or more) target mesh voltages, and the increased trouble caused by microphony has followed directly on the adoption of 3V as a standard target potential by major camera tube users because of the better tonal gradation afforded. Shock microphony is in every way similar to the microphony encountered in high-gain amplifier valves, and is dealt with in a similar manner. Movement of the target is equivalent to moving one plate of a charged capacitor, causing a variation in potential at each point of the target. When this occurs during scanning, the potential variations are visible on the monitor picture as horizontal

bands of light and shade moving up or down the picture. The effect is very similar to sound on vision and can easily be confused with it, since the movement and number of the bands varies with the pitch of the sound. One distinguishing feature is that sound-on-vision occurs over all the audio frequencies, but shock microphony tends to be confined to the frequencies around the resonant frequency of the target, usually between 350 and 500 Hz.

A cure may be effected by using soft spacing strips between target and mesh, but this causes practical difficulties, since the thickness of the strips must be of the order of 0.001 inch or less, and no projections are permissible. A compromise may be reached where normally constructed tubes are used for the older types of cameras, and specially non-microphonic tubes for cameras which use motor driven lens turrets or motor-operated zoom lenses.

Electrical or "spontaneous" microphony is due to the combined effect of the electrostatic forces due to the charge on the target and the magnetostrictive forces caused by the action of the scanning fields on the metal ring holding the target. The magnetostrictive effect slackens the target so that the magnetic field increases, and the electrostatic field increases the attractive force between target and target-mesh as the target is discharged to cathode potential. The combination of the two causes the target to vibrate at its resonant frequency; the vibration is erratic, however, since the forces on the target vary with the over-all charge and the degree to which the target is discharged.

Factors favourable to spontaneous microphony include high target voltage, low light levels and high scanning field strengths at the target. It is unfortunate that the metal most suitable for sealing to soda-glass, a 50% nickel iron alloy, is also the Ni Fe alloy with maximum magnetostrictive effect. The substitution of titanium for nickel-iron in the E.M.I. 4½-inch camera tubes in 1964 effected a complete cure of the spontaneous microphony problem, and no difficulty is presented by the electronically-conducting glasses, since they generally use rings of molybdenum, which also exhibit negligible magnetostriction.

**The First Dynode.**—The problem of the scanned surface of the first dynode has been tackled electrically and chemically. If the whole gun is tilted (the beam being straightened by a correcting coil) only a part of the surface is in focus for the return beam. A more elegant method is to use a tilted or curved dynode surface, though this causes fabrication and assembly problems. The surface finish and material used for the dynode are both of considerable importance; a smooth matt finish is desirable, and materials include silver-magnesium alloy, chromium and nickel. At present materials may be chosen for long life or for minimum visibility but not both although much was hoped for the nickel dynode at one time.

With the new electronically conducting targets offering very much longer target life-times, the need for a long dynode life to match this has intensified the work being

done on the production of new dynode surfaces.

**Beam Noise.**—The limiting factor in the signal-to-noise ratio of the camera tube is the beam noise. This limitation is aggravated by the tube operating conditions, which cause maximum beam current to return in black areas where beam noise is very visible. The change to 625 lines has made this more obvious, since the signal-to-noise ratio is some 3 to 5 dB lower at the higher scan rate compared with that of 405 lines.

The obvious thing is to reduce the noise of the beam leaving the cathode and this may be done to some extent by using a cathode surface of better finish or of better geometry. A similar problem is encountered with travelling wave tubes, and smooth concave cathodes have materially assisted in reducing beam noise.

A more radical approach is to redesign the tube for Isocon operation. The Isocon principle known for some considerable time but never used commercially until very recently, reduces beam noise by separating off the unmodulated portion of the return beam current and allowing only the modulated portion to reach the first dynode. The modulated portion of the return beam is that portion which is elastically reflected by the target voltage, the remainder of the return beam being electrons which have been scattered at the target, and which, because of their random velocities, constitute a noise signal. In principle, these two components of the return beam can be separated on the basis of their differing lateral velocities by means of deflecting fields and a partition. Working Isocons have been produced, and have a marked superiority in signal-to-noise ratio over conventional image orthicons, but it is doubtful if their very high cost could be justified in broadcast television use, even on 625 lines where the higher scan rate has the effect of reducing the signal-to-noise ratio obtainable from the tube.

There is much work to be done on the image orthicon. The 4½-inch tube does not have the resolution superiority over the 3-inch which theory would indicate. Some of this lost resolution is due to the image section (more elaborate than that of the 3-inch tube) which suffers from the inevitable lens distortions. Some improvement in resolution (3 dB increase in signal at 5 MHz) can be obtained by quite small changes in electrode shapes in this section. A further loss of resolution arises from the difficulties of maintaining focus and orthogonal target landing over the larger area of the 4½-inch target; this problem should be tackled by designing the tube and its scanning yokes together. As far as the target region is concerned, the processes of electron distribution which take place at the target are certainly not well understood, yet these processes are fundamental to the operation of the tube. Some of the problems may never be tackled now that all the manufacturers of image orthicons are also making lead-oxide vidicons.

The writer wishes to acknowledge gratefully the help of E.M.I. Ltd. in the provision of information and photographs.

**McMurdo plug in modules are  
cheap \* heartless \* repulsive \* unfeeling**

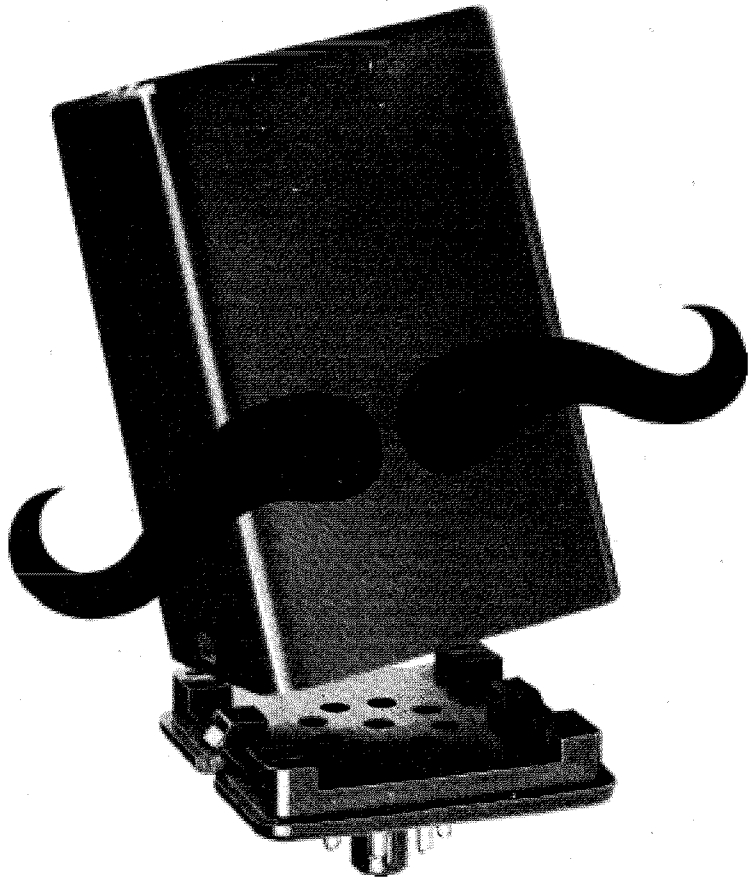

**and very popular**

Lots of people love McMurdo 8 and 11 pin plug-in modules – because they're made to the highest standards for the lowest, most competitive cost. No guts . . . which means you can build your own, and all your interchangeable circuitry will be well protected because the strong, polycarbonate covers repel knocks and bangs without being damaged. McMurdo modules have no feelings when it comes to temperature either – they work as well at  $-50^{\circ}\text{C}$  as they do at  $+90^{\circ}\text{C}$ ! No wonder they're so popular . . . can you provide a good home for some? Write or 'phone now to:

**McMURDO** ELECTRONIC COMPONENTS

THE McMURDO INSTRUMENT CO LTD, RODNEY ROAD  
PORTSMOUTH, ENGLAND, TEL 35361. TELEX 86112

11 pin module comprising base MP4580 and cover MP4581, which can accommodate up to 4 "Vero-boards" of 0.150" pitch cut to size to order (MP4582).  
Overall seated height 3.12"  
Overall width 1.95"

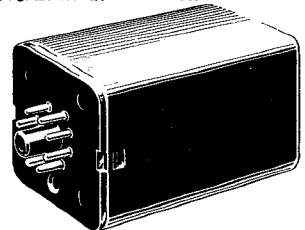

8 pin module comprising base MP4583 and cover MP4581 otherwise identical to 11 pin version.

Authorised Stockists:—LUGTON & CO. LTD., 209/210 Tottenham Court Road, London W.1. Tel.: Museum 3261. SASSO, P.O. Box No. 20, Gatwick Road, Crawley, Sussex. Tel.: Crawley 28700 (also Chipping Sodbury 2641, Cumbernauld 25601 and Hitchin 2242) and agents in principal overseas countries.

# It all points to the new BSR UA75

Check the features on the remarkable new BSR UA75 automatic/manual unit. For £17.11.5 (inc. £3.1.11 P.T.—cartridge and plinth extra) it gives you a die-cast turntable, switch 'pop' filter, changer muting switch and many other sophisticated ideas usually found only on much more expensive units. BSR have done it again—and it's their best ever.



Also available, the UA65 at £11.10.1 (inc. £2.0.7 P.T.) and the UA70 at £14.10.9 (inc. £2.11.3 P.T.).

 **BSR**  
for better sound reproduction

BSR Limited,  
Monarch Works,  
Cradley Heath,  
Worley, Worcs.

WW—102 FOR FURTHER DETAILS



# Demonstrating A.C. Theory

## Sampling method using a strobing meter

by J. G. Assenheim, M.Sc., B.Sc., M.I.E.E.

That current should exist in a circuit when the voltage is at zero and vice-versa may be accepted by many students as a theoretical proposition, but it is regarded with scepticism as far as practical circuits are concerned. On first acquaintance, the beginner finds difficulty in appreciating the phase relationships which exist in an a.c. circuit with reactive components. Many lecturers feel that a practical demonstration, to show that these phase relationships do indeed exist, helps to clear up any doubt in the student's mind.

Unfortunately, demonstrations of this type are not easily performed, except on a double beam oscilloscope and, as many second-year students are not familiar with the function of these instruments, they remain unconvinced. Most students approaching a.c. theory for the first time have had experience with, and have learned to trust, the simple moving coil meter. A demonstration showing voltages and currents displayed on centre-zero meters placed at various points in a circuit which is energized with a very low-frequency sinusoidal voltage appears to be the most instructive form of demonstration. A number of colleges provide this type of exercise and typical examples have appeared in *Wireless World* in the past few years.<sup>1,2,3</sup>

If the frequency of the source is to be sufficiently low to enable the waveforms to be examined on a number of meters simultaneously, then the component values required are inconveniently large. If the display is not to confuse students, and the lecturer is to be given sufficient time to describe what is happening, the frequency should not be higher than about 0.2Hz, i.e. one cycle in 5 seconds, and if several meters are used it should be even lower. Unfortunately, at this frequency the component values for a typical demonstration turn out to be about 20,000  $\mu$ F and about 10,000H.

If one is prepared to allow the added complication of an additional d.c. polarizing voltage to be present in the circuit, the necessary capacitance can be obtained using electrolytic capacitors but an inductor of the required value is necessarily very large and expensive. Moreover, inductors as large as this tend to have very low  $Q$  values and saturate easily making some demonstrations, such as, for instance, log-

arithmic decrement of a ringing tuned circuit, impracticable.

A compromise is to simulate a large inductance with a "black box" utilizing some thermal device such as a thermistor or using other electronic circuitry. An example of this approach has been given in *W.W.*<sup>1</sup> In the writer's experience, however, students find such a black box unconvincing and the whole point of the exercise fails when it is necessary to resort to this technique, especially as in many cases the reactance of the device decreases with increasing frequency and it often needs a d.c. polarizing voltage before it will work at all.

### Use of a strobing meter

A much more elegant approach is to use one of the new strobing meters which are now available and which do not require low frequencies or large components to allow complete investigation of an a.c. circuit. This

type of instrument works by sampling any input waveform for a very short period once per cycle and integrating all of the sampled pulses to build up an exact copy of the waveform, but at a much lower frequency. The frequency of the sampling action is adjustable and by setting the sampling rate to be nearly that of the input frequency, a very low frequency representation of the input waveform is obtained in the same way as an optical stroboscope provides a slow motion representation of a periodic mechanical motion. The strobing meter provides a slow motion copy of an a.c. waveform on a centre-zero meter and the demonstration appears similar to the v.l.f. demonstration described previously.

The manner in which the instrument operates is illustrated in Fig. 1. As an example, a simple a.c. circuit containing resistance and inductance is shown and the waveforms of voltage and current are shown alongside.

*A simple experiment used to demonstrate the phase of voltages developed across a resistance and inductance in series, in relation to the current phase.*

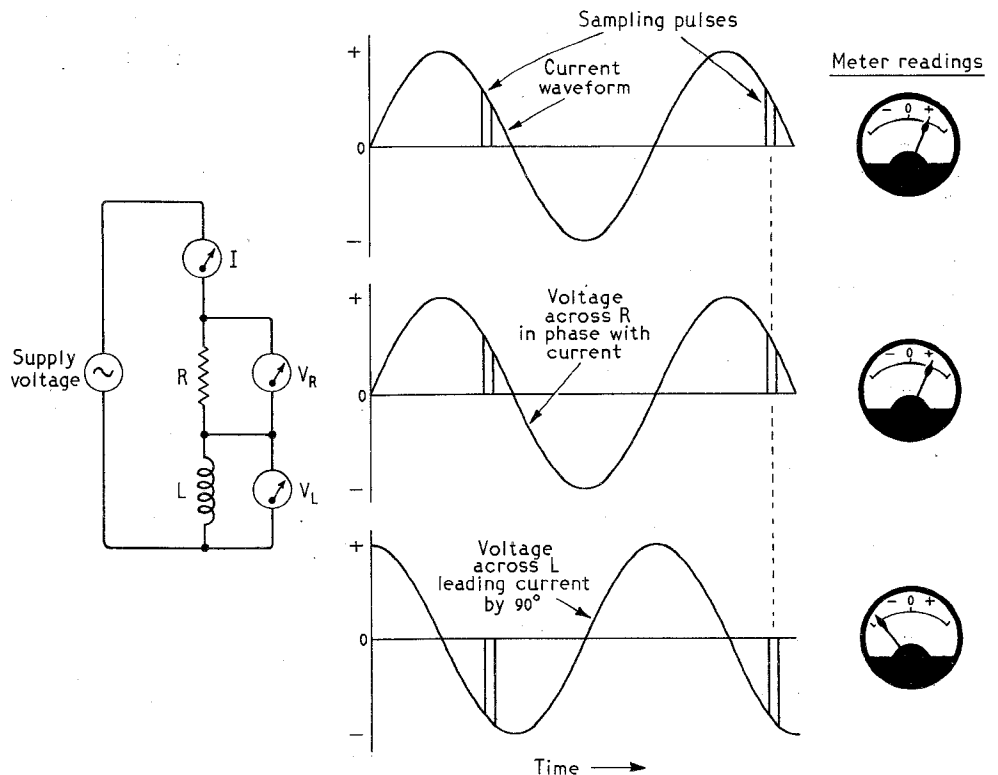

# Manufacturing Colour Tubes

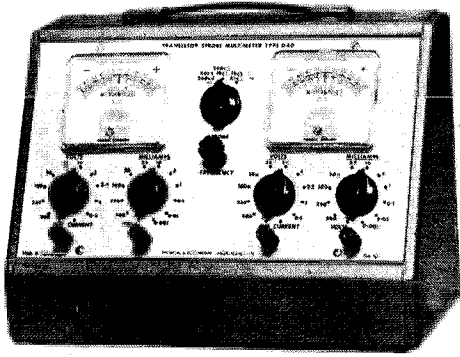

The P.E.L. strobing multimeter which, as described in the text, can be used to investigate an a.c. circuit for demonstration.

The readings on the meters resulting from the sampling pulses are indicated, and these would be steady readings if the sampling rate was made equal to the supply frequency. In practice, for demonstration purposes, the sampling rate would be slightly different from the supply frequency and the sampling pulses which occur once per cycle would appear at a slightly different position in each successive cycle. The difference between the sampling rate and the supply frequency is the apparent display frequency and this can be as low as required. It would normally be adjusted to a convenient speed for the particular demonstration being given. The real frequency can be any suitable frequency available such as 50Hz or higher. Component values required are quite small and for a typical demonstration at 1kHz suitable values would be around  $0.01\mu\text{F}$  and 100mH. Several meters may be used together in this way and, providing the sampling pulses all occur together, each instrument indicates the voltage or current and its phase in the same way as the simple centre-zero meters indicate these values in the v.l.f. circuit described previously.

A good example of an instrument of this type is the Strobe Multimeter D40\* shown in Fig. 2. This contains two independent multimeters in one case, permanently synchronized together so that relative phase as shown on the centre-zero meters is always correct. Each multimeter has eleven current ranges from  $1.0\mu\text{A}$  full scale to 500mA full scale, and ten voltage ranges from 0.5V full scale to 500V full scale. As the input resistance on the voltage ranges is  $1\text{M}\Omega/\text{V}$  the instrument does not affect the working of the circuit to which it is connected.

The writer has found that this method of demonstrating the action of a.c. circuits is readily accepted by students as they are often familiar with the way in which a stroboscope works.

## REFERENCES

1. "Demonstrating a.c. theory," by T. Palmer. *Wireless World* Oct. 1963.
2. "Demonstrations at v.l.f.," by T. Palmer. *Wireless World* June 1966.
3. "Demonstrating rectifier action in slow motion," by T. Palmer. *Wireless World* Feb. 1968.

\* Manufactured by Physical & Electronic Laboratories Ltd., 28 Athenaeum Rd., Whetstone, London, N.20, of which the author is chief engineer.

Mass production of shadow-mask colour television tubes is well under way at the Mullard cathode-ray tube factory at Simonstone, between Preston and Burnley, Lancs. This plant, which started up in 1955 and has a production capacity of  $1\frac{1}{2}$  million monochrome tubes a year, manufactures everything for the colour tubes except the shadow mask and the components for the electron guns. Covering 44 acres and employing 2,000 people, it has two distinct parts—a glass factory (incidentally one of the largest in the U.K.) and a tube assembly and screen laying plant. Assembly and screen-laying processes are basically similar to those outlined in a *Wireless World* article last year\* but there is a greater proportion of automatic machinery than in the small plant operating. The production rate at Simonstone depends, of course, on the demand for colour television receivers, but Mullard say that by the end of 1968 the works will be capable of manufacturing 150,000 shadow-mask tubes a year. The two sizes of colour tubes, 25-inch and 19-inch, are made in alternate runs (of several weeks or months

\*"Colour Tube Production", September 1967 issue.

*Performance testing completed tubes. In this five-position test bay checks are made for blemishes in each colour and in white, for convergence, linearity, cathode quality and other characteristics. The work is speeded up by measuring aids such as digital read-out for colour purity tests, and the whole bay has a throughput of up to 30 tubes an hour.*

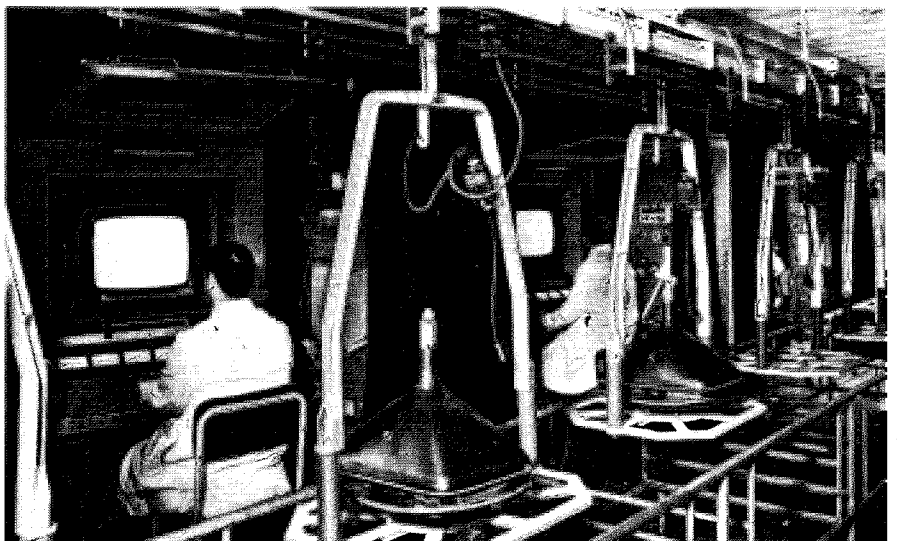

each) as parts of the machines have to be changed to handle the different sizes of components.

The glass factory, which produces the cones and faceplates, comprises three main parts: a weighing, dispensing and mixing area for raw materials; an oil fired furnace, operating at  $1,550^{\circ}\text{C}$ ; and two automatic glass forming presses. The cone and faceplate of the colour tube require different types of glass, so the plant only produces one of these components at a time (one of the two presses acting as a standby). To change from one type of glass to the other takes about ten days. The furnace operates continuously and can handle 100 tons of glass a day.

What does all this mean to the customer? There does not seem to be any established retail price at which a shadow-mask tube can be bought over the counter. Last September Thorn-AEI Radio Valves and Tubes Ltd. said that the retail price for a 25-inch tube was "in the region of £90-£100". (Receiver manufacturers, however, can buy 25-inch tubes for about £55 each and 19-inch tubes for about £45 each.)

# Series Voltage Stabilization

A review of the properties of conventional voltage stabilizers and a practical circuit incorporating automatic overload protection without employing extra transistors

by Jan-Erik Sigdell\*

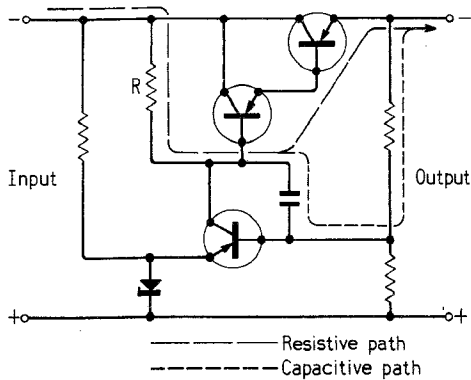

Fig. 1 Conventional voltage stabilizer.

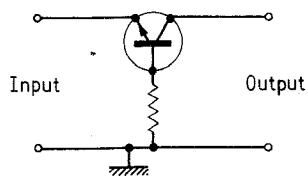

Fig. 2 Illustrating the resistive path from input to output. The ripple in the base current modulates the collector current.

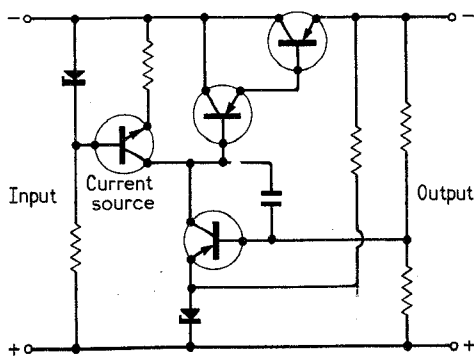
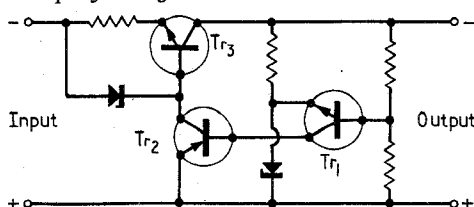

Fig. 3 Employing a current generator to eliminate resistive and capacitive paths from input to output.

Fig. 4 This circuit is bistable and tends to trigger into the cut-off state if the load is rapidly changed between two values.



Most transistor circuits for series voltage stabilization used today are of the type shown in Fig. 1—or of a similar type (the lower transistor is often replaced by a differential pair). This circuitry has the following two disadvantages. (1) There exist resistive or capacitive paths from input to output, which tend to raise the hum at the output and (2) there is no inherent protection against overload, either for the stabilizer or for the load itself. The first of these two disadvantages is especially serious when a path passes through an active component in such a way that its hum-raising influence is amplified (e.g. through the base-emitter diode of a transistor). This disadvantage is often overcome by more amplification in the feedback loop or e.g. by dividing resistor  $R$ , in Fig. 1, into two resistors and

\*Chalmers University of Technology, Göteborg S, Sweden.

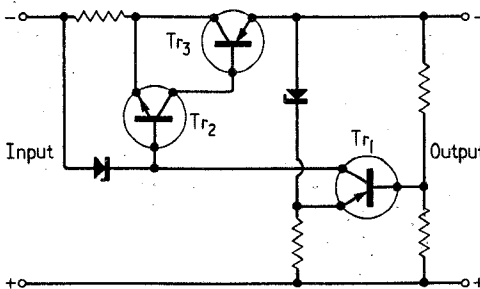
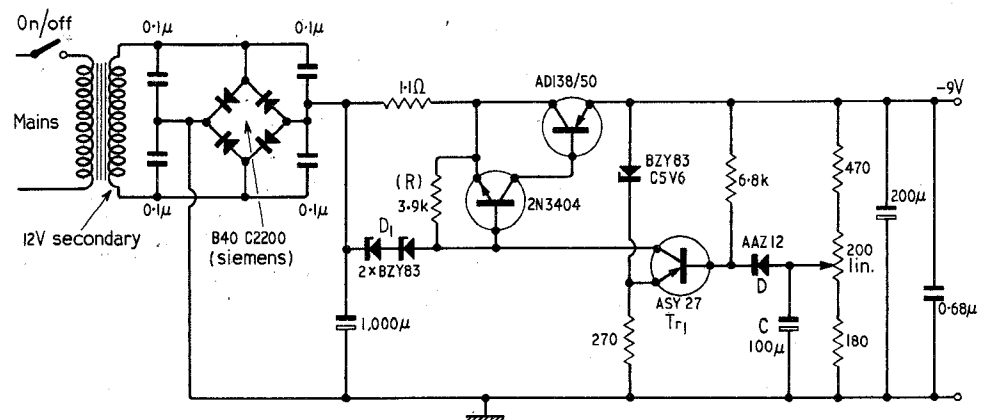

Fig. 5 A circuit that can be made to behave in a monostable fashion, the current cut-off state only being reached in the event of overload.

Fig. 6 A practical circuit utilizing the properties discussed.



decoupling their interconnection with a capacitor or a Zener diode. The second disadvantage is often overcome with an extra circuit for current limiting or current cut-off.

Concerning the first disadvantage, it must be kept in mind that a configuration such as the one in Fig. 2 shall be regarded as having a resistive path from input to output (grounded side), as the ripple in the base current modulates the collector current. Concerning the second disadvantage the series transistor (transistors) should, at a determined current level, change over from being a part of a voltage stabilizer to being a part of a current stabilizer or a current cut-off circuit.

The first requirement can be fulfilled with the Zener diode decoupling method previously mentioned or by employing a current generator<sup>1</sup> as in Fig. 3 (if Zener diodes are regarded as ideal). Two other solutions that fulfil both requirements are shown in Figs. 4 and 5. Clearly stabilizers using these designs may become bistable and the only way to ensure monostability in the voltage stabilizing mode is to provide 'on' leakage currents. This is not unrealistic for the circuit of Fig. 5 as will be seen. On the other hand one may introduce extra current sources through reversely polarized diodes with sufficient leakage currents. Also the new field-effect current limiting diodes are of interest for this purpose, although as yet expensive. Another possibility is to put a Zener diode across transistor  $Tr_3$ , Figs. 4 and 5, which conducts when the output voltage is low but cuts off when it reaches its stabilized value. However, this requires a sufficient value of resistance in series with

# Hanover Fair Grows Internationally

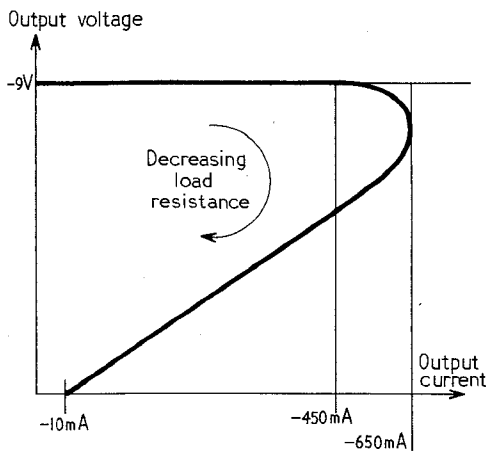

Fig. 7 The current cut-off characteristic of the circuit of Fig. 6.

the Zener diode in order to limit the short circuit current at the output.

Bistability may also be an advantage, but only if the circuit automatically triggers itself into the voltage stabilizing state when the input voltage is applied and the output loading is not excessive. Furthermore, it should not trigger to the cut-off state if the load is suddenly changed between two permitted values. The circuit of Fig. 4 has both of these undesirable properties.

The circuit in Fig. 5, however, can be monostable, so that the cut-off state can be achieved only when an overload exists. This is due to the leakage current in transistor  $Tr_1$  which is amplified twice in transistors  $Tr_2$  and  $Tr_3$  and drives the circuit from the cut-off state when the output loading is within limits.

A practical realization is shown in Fig. 6. The author has used this in a transistor communications receiver for almost a year. The diode  $D$  is included for temperature stabilization (it tends to cancel the change with temperature in the base-emitter voltage of  $Tr_1$ ). The capacitor  $C$  reduces the hum further. The resistor  $R$  raises the collector current of transistor  $Tr_1$  to a more suitable working point (with a more constant input resistance). The circuit has the current cut-off characteristic shown sketched in Fig. 7. Its output resistance, measured statically from the change in output voltage at application of a 300 mA load, is  $0.13 \Omega$ . The hum is less than 10 mV peak-to-peak at a load of 300 mA.

When considering exhibitions on a grand scale, the Hanover Fair ("Hanover Messe"), which began in 1947 as an exhibition of German manufactured products, must now surely rank among the biggest and most international in the world. It is a large self-contained entity situated in the rural outskirts of this West German city, with its own airport with light aircraft running a shuttle service to and from the main Hanover airport. An internal electric bus service gives visitors a free ride from one section to another and there are even travelling "pavements" from which visitors can admire the pleasant surroundings in which the exhibition is set, as they are glided slowly to their next point of call.

The Fair, held this year from April 27th to May 5th, comprises some 28 pavilions set in close proximity to each other as well as a large area of outdoor exhibitions, mostly of heavy machinery. Most of the pavilions would each be capable of absorbing the total area of, for instance, London's Earls Court pavilion, and it took three of these to house the electronics section alone. This section embraced electrical installation equipment, control gear, radio and television, aerials, business machines, computers and test and measuring equipment. In the television section the accent was, naturally, on colour, and a few of

the more outstanding items of interest will be reviewed in the July issue of *Wireless World*. The majority of receivers demonstrating colour were operating on the PAL system but some were being shown which were intended for the French SECAM market. The Association of French Exporters of radio and TV sets had several stands showing SECAM colour pictures on 58cm receivers. They were using their own generating equipment which provided six channels of colour stills. On some of the screens a horizontal pattern could be seen but this was explained as being due to direct pick-up of interference from a nearby mains feed to the building. At any rate, even in this location SECAM could not suffer from the simple PAL defect—"Hanover blind"!

Some 5,500 exhibitors from Europe and overseas countries were at the Fair, which has come to be regarded as the shop window for world technology, and in passing it should be mentioned that products from Japan in particular were much in evidence. Sony were demonstrating a miniature television receiver measuring about  $4 \times 7 \times 20$ cm long with a 2.5cm c.r.t. at one end. The circuit is designed around i.c.s and it covers the full v.h.f. and u.h.f. bands. The receiver can operate from the mains or as a portable using a battery-pack. It costs in the U.S.A. about £100.

## REFERENCE

1: "Taschenbuch der Hochfrequenztechnik", Meinke/Grundlach: p. 1626.

## Circuit Ideas

A regular feature on original ideas in circuitry which have been found practical is to be started in *Wireless World*. Presented in the form of short notes, the items will be essentially functional "bricks" which somebody has found useful at some time. Performance, originality of realization and economy of components will be the most important criteria. Readers are invited to contribute to this series: the more ideas we get the better will be our selection.



# New Products

## Low-cost Counter

A development of their 12.5-MHz frequency meter/counter/timer incorporating both i.c.s and a memory store has been introduced by Venner at £245. Each counter board comprises three modules; a decade, a store and a display tube drive module. The instrument, type TSA 6636/2M, is designed for general purpose applications in industry and gives a 6-digit readout, including decimal point, with a figure size of 0.6in. An optional extra is a 1248b.c.d. printer output. Because this output is available from the memory, the printer can operate while the next result is being measured, thus increasing the cycling rate over previous models. For frequency measurement (10Hz to 12.5MHz), gating times are 1 $\mu$ s to 10s in decade steps. Input sensitivity is 75mV into 250k $\Omega$ . Single and multi-period measurement covers a 10Hz to 1MHz range with periods from 1 to 10<sup>7</sup>. As a timer the TSA 6636/2M covers 1 $\mu$ s to 10s in decade steps, single and two-line start/stop facilities being provided. Provision is also made for

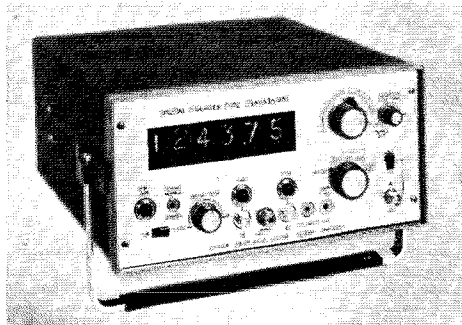

gated counting. Display time is variable from 0.5 to 5 seconds or infinite, and accuracy is  $\pm 1$  count  $\pm$  crystal stability ( $\pm 1 \times 10^{-6}$ ). Venner Electronics Ltd., Kingston By-Pass, New Malden, Surrey.

WW 304 for further details

## New Tracking Filters

Two new tracking filters which are based on the AIM voltage programmable filter (PFO 166) instead of the conventional heterodyne systems using mixers and oscillators, have been announced by AIM Electronics. Analogue computing techniques are employed to simulate a perfect LC filter in which the centre frequency may be varied by an external programming voltage. An application for tracking filters is in vibration studies where resonant frequencies are formed by applying vibrations of increasing frequency to an object under test. The tracking filter is required to eliminate noise and harmonic effects from the resonance detector output signal by following the

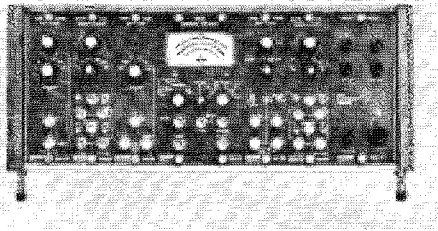

increasing vibration frequency. The System 5.18 tracking filter has a frequency range of 0.1Hz to 50kHz and is capable of sweeping at up to 50kHz over frequencies of 300:1 without changing switched ranges. System 5.19 is similar but includes an independent swept oscillator which provides signals suitable for driving vibrators. AIM Electronics Ltd., 71 Fitzroy Street, Cambridge.

WW 307 for further details

## A.M./F.M. Signal Generator

Amplitude and frequency modulation facilities are combined in a new m.f./h.f. solid state signal generator TF 2002AS announced by Marconi Instruments. Based on the a.m. signal generator TF 2002, this new instrument incorporates several supplementary features which considerably extend its scope. TF 2002AS is suitable for all types of measurement on a.m. and f.m. receivers, i.f. amplifiers and demodulators within its frequency range—including dynamic measurements normally outside the scope of most signal generators below 30MHz. It covers the carrier frequency range 10kHz to 72MHz with provision for a.m. up to 100% at modulating frequencies from 20Hz to 20kHz. The internal modulating oscillator is tunable to any frequency in this range. An incremental tuning control is calibrated directly in frequency with symmetrical scales for positive and negative changes. Although provision has been retained for standardizing its accuracy against the internal crystal calibrator, the direct calibration remains valid within 15% for all main

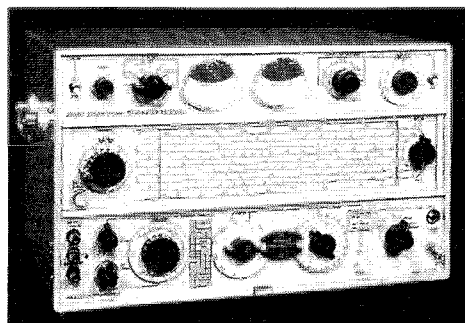

tuning ranges above 100kHz without trimming. External frequency shift and remote carrier levelling facilities are both fully symmetrical. A d.c. control voltage variation of  $\pm 1$ V produces frequency shift ranging from  $\pm 0.5$ kHz at 100kHz to  $\pm 50$ kHz on the highest frequency ranges. At the lower carrier frequencies, the shift range has been increased more than three times so that the swept-frequency bandwidth display facility has been usefully extended into the m.f. band. High control sensitivity permits utilization of the low voltage sawtooth output of transistor oscilloscopes. Carrier levelling, up to  $1 \pm 100\%$  variation on the initial output voltage, is obtained by application of up to  $\pm 6$  volts d.c. input. Price £987. Marconi Instruments Ltd., St. Albans, Hertfordshire.

WW 305 for further details

## Linear I.C.s

Four new linear integrated circuits available from Mullard are enclosed in multi-lead TO-5 encapsulations. Operational amplifier TAA241 is designed for general purpose applications in instrumentation and control. It is a special version of the TAA243. Nominal supply voltages +12V and -6V, and operating temperature range is 0 to 7°C. Input and output impedances are 32k $\Omega$  and 200 $\Omega$  respectively. Offset voltage is 1.5mV and offset current 0.5 $\mu$ A. Large signal voltage gain is 3,400. The TAA300 is an a.f. amplifier which, with 10mW input will give an output of 1W. It is designed for 9-volt operation. Input impedance is 8 $\Omega$ . Low-noise a.f. pre-amplifier TAA310 is designed for use in record/playback units. With a supply of 7V the voltage gain is greater than 95dB and input impedance exceeds 10k $\Omega$ . Operating temperature range is -20 to

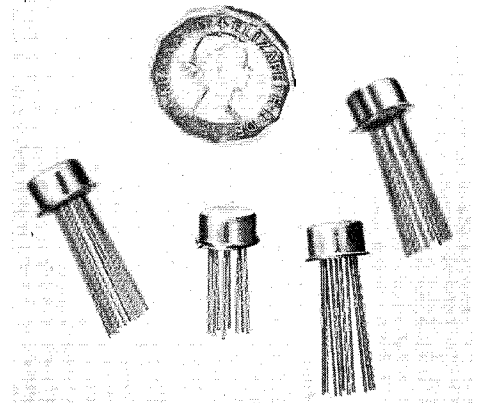

+75°C. Amplifier TAA350 is a wideband, differential, limiting amplifier for use with an f.m. carrier at about 6MHz and is particularly suitable for television intercarrier sound amplifiers. Nominal supply voltage is 6V and input limiting voltage is 100 $\mu$ V. Input resistance is 2.5k $\Omega$  and output resistance 80 $\Omega$ . Typical voltage gain is 65dB. Mullard Ltd., Torrington Place, London, W.C.1.

WW 302 for further details

## New Frequency Standard

Output signals in decades from 10kHz to 10MHz, with extremely close limits of frequency accuracy and stability, are provided by a new frequency standard, the FS3, from Advance Instruments. This instrument is particularly suitable as an external standard frequency where digital frequency meters and timer counters are required to measure to high accuracy, or for use as a precision laboratory standard to which other equipment may be referred, the aging rate being

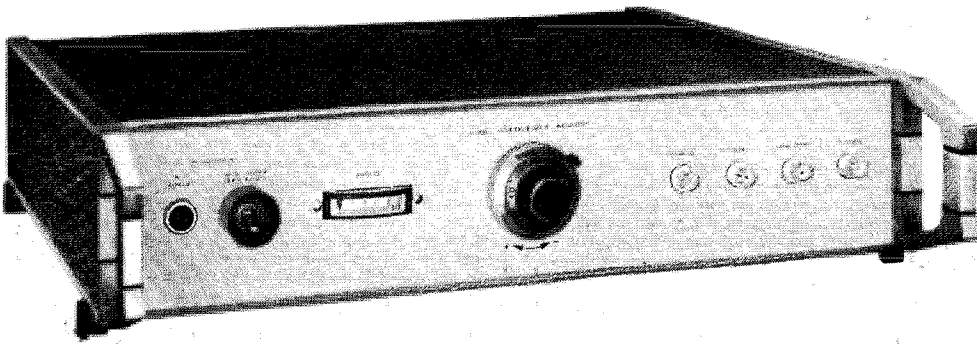

as low as 2 parts in  $10^9$  per day after 30 days' operation. It incorporates an integral charger and rechargeable battery. Should the mains supply fail the instrument automatically continues to operate at full accuracy on the batteries for up to four hours. When the mains supply is reinstated, the battery is automatically recharged. The FS3 utilizes as its master oscillator an oven-controlled 5MHz crystal. The oven current is monitored for correct operation by a front panel meter. Extensive use of integrated circuits has been made in the design of this instrument. Price £325. Advance Electronics Ltd., Hainault, Essex.  
**WW 303 for further details**

## Switching Programmer

A switching programmer measuring  $8 \times 8$  cm in cross section and 25.5cm long, including the motor, is designed to replace 32 d.p.d.t. relays and related control devices which may be currently employed in conventional switching systems making it possible to greatly reduce wiring and space requirements. It also permits greater flexibility in

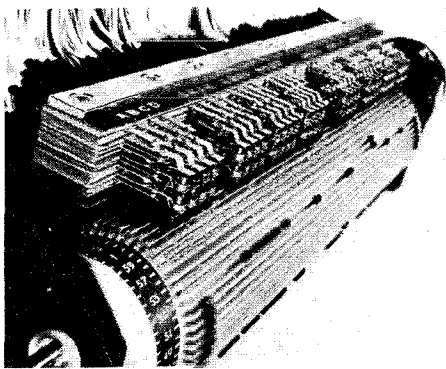

setting up and changing required switching patterns. Now available from Sealectro this model 96D programmer can control 96 s.p.d.t. contacts each of which is electrically isolated to control independent circuits. Contacts are rated to make and break 2A at 230V a.c. or 24V d.c. (resistive load) and the unit's memory drum can be programmed to actuate any number of contacts in groups of three at any of the 60 drum positions. Standard operating voltage is 230-240V a.c. Sealectro Ltd., Walton Road, Farlington, Portsmouth, Hampshire.  
**WW 310 for further details**

## New T.T.L. I.C.s

Transitron Electronic, has announced three additions to its Series III range of t.t.l. integrated circuits. They are two 4-bit ripple counters and a 4-bit shift register. Both ripple counters are monolithic and have been designed for high speed, high noise immunity, high output capacitive and current drive capabilities. Both consist of four flip-flops which have been arranged to give a

one-way binary ripple counter (TRC 2521-2524) or a binary code decimal ripple counter (TRC 2525-2528). Temperature range of both types is  $-55$  to  $+125^\circ\text{C}$  and other significant parameters include power consumption of 18mW at 5V; count frequency 25MHz; output current drive 20mA. Other features include low current loading, complete t.t.l. compatibility, and saturated "HLTTL" circuitry. Both counters find application in a wide range of multiplexing, data logging, and flight data recording situations. The new shift register (TSR 2511-2514) is also a monolithic 4-bit device, designed for high speed, high noise immunity, and a high output capacitive and current drive capabilities. Input and output from the four flip-flops are arranged in four different combinations to provide serial in-serial out, serial in-parallel out, parallel in-parallel out, parallel in-serial out operating modes. Enable/disable outputs do the mode selection and no external connections have to be made to switch from one mode to another. The new register can also be converted into left/right shift by simple external connections. Temperature range is  $-55$  to  $+125^\circ\text{C}$ ; power consumption 195mW at 5V; shift frequency 25MHz; output drive 20mA; and power supply, single 5V. All three circuits are available in either 14-lead flat pack, or 14-lead dual-in-line package. Transitron Electronic Ltd., Gardner Road, Maidenhead, Berkshire.  
**WW 301 for further details**

## Radio Communications Equipment

The first items in a new range of h.f. equipment introduced by Redifon Communications Division are the G450 1kW h.f. general purpose transmitter; the R499 10-channel m.f./h.f. s.s.b./d.s.b. receiver, and MCU6 aerial distribution amplifier. Particulars have also been given of the TT20 telegraph terminal unit which, although specially designed for the Royal Navy, is now available to other naval, military and commercial users. Type G450 is a self-contained s.s.b./d.s.b./c.w. transmitter without the need for external drive units. It operates on up to ten crystal-controlled channels in the 1.5 to 30Mhz frequency range with provision for an external frequency source such as a frequency synthesizer. The transmitter comprises a driver/p.a. unit, an exciter unit and a power unit, employing transistors in all but the drives and p.a. stages. The exciter unit can be used independently as a drive unit for other linear amplifiers. Type R499 is a fully transistorized receiver which is available in a number of versions to suit individual service and system requirements. Crystal filters are fitted internally according to the modes of signal to be received, and these are available for c.w., s.s.b., d.s.b. and i.s.b. The receiver operates on up to 10 channels in the h.f. band and, with the addition of filters, also on the 255-525 kHz band. Noise factor is generally better than 7dB and front end protection is provided against e.m.f.s of up to 30V r.m.s. The a.g.c. system employed ensures that the gain of the i.f. stages is reduced before that of the r.f. stages,

and precautions are taken to prevent large signals from introducing intermodulation distortion. Remote control facilities (in conjunction with a remote control unit type RC116) include channel selection, service and on/off switching, fine tuning, a.f. monitoring and channel-in-use indication.

Type MCU6 aerial distribution amplifier has a dynamic range of 135dB extending from below  $1\mu\text{V}$  to 5V total input e.m.f., over a working frequency of 95kHz to 30MHz. Using silicon planar transistors throughout, the circuit comprises a push-pull amplifier with an associated wide-band a.g.c. system controlling a front-end attenuator. The a.g.c. begins to operate at an aerial input e.m.f. of approximately 500mV and limits the output to about 500mV, thus protecting associated receivers and permitting continued reception of a wanted signal in the presence of strong signals which would normally block the system. Two versions of the MCU6 are available: type A accepts a single input and provides ten outputs; type B contains two independent amplifiers each with one input and five outputs. Constructed for standard 19-in. rack mounting with a  $3\frac{1}{2}$ -in. front panel, the MCU6 normally operates from

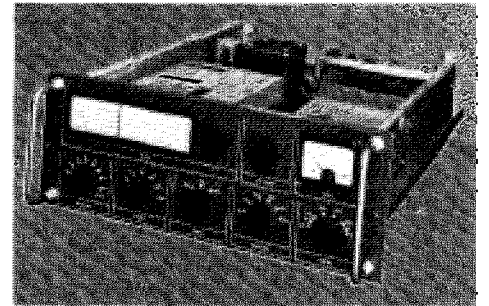

100-125V or 200-250V 45-65 Hz, or can be made to special order to operate from 24V or greater d.c. supplies, with positive or negative earth.

Type TT20 telegraph terminal unit comprises twin v.f. receivers for independent simultaneous operation, and common power supply unit. As part of a modern communications system, each receiver forms part of a single teleprinter channel and accepts either a two-tone frequency exchanged keyed, or a frequency shift keyed telegraph signal, which it converts to a 1kHz tone or to a low-level d.c. signal.  
**WW 316 for further details**

## I.C. Patchboard

A rapid means of interconnecting integrated circuits and discrete components is provided by a new patchboard system by Circuit Integration Ltd. All types of i.c. configurations are catered for and special carriers are available for mounting other electronic components. In use, the components are mounted on the carriers permitting them to be plugged-in to any one of the patchboard range. Power supply connections are automatically applied to each carrier, and interconnection between devices is carried out by means of plug-in links. Five sizes of patchboard are avail-

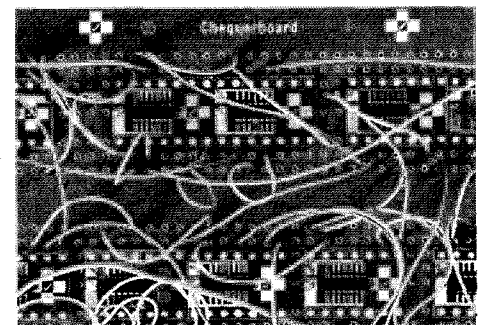

able, offering 12, 18, 24, 30 or 48 pin circuits. Circuit Integration Ltd., 99 Bancroft, Hitchin, Hertfordshire.  
**WW 312 for further details**

## High-Frequency F.E.T.

A low-cost high-frequency n-channel field effect transistor suitable for r.f. mixers, amplifier front ends, switching and general purpose applications is available from Union Carbide UK Limited. The new f.e.t., type UC734, has a minimum mutual conductance of  $3\text{mA/V}$  at 200MHz and a pinch-off voltage between  $-1$  and  $-8\text{V}$ . The reverse transfer capacitance is  $0.8\text{pF}$ . Price of the UC734, for quantities of 25-99, is 9s 8d each. Special selections are available to customer specifications for a nominal charge. Union Carbide U.K. Ltd., Electronics Division, 8 Grafton Street, London, W.1.

**WW 308 for further details**

## Two-way Telephone Amplifier

Telephone conversations up to a distance of 25ft from the telephone are possible using the Magnafone Mark 10, say the makers of this two-way telephone amplifier. There is no electrical connection with the telephone, a hearing-aid type microphone picks up the speaker's voice which is amplified and conveyed via the telephone to the caller. The caller's voice is received through a loudspeaker. A number of persons can participate in the conversation. The instrument is battery-operated and is contained in a case about the size of a telephone. In operation the handset is placed on top of the case. The microphone and loud-



speaker volume controls regulate between the maximum and medium gain, so that when they are set at zero the instrument is still operative. Price of the Magnafone Mark 10 is 29gn. The Magnetic Broadcasting Co. Ltd., Paragon Works, Ruvigny Gardens, Lower Richmond Road, Putney, London, S.W.15.

**WW309 for further details**

## Stabilized Power Supplies

Fully variable output with a choice of current ratings from 1 to 10A are the facilities offered by a new range of modular power supplies types PM16-19 announced by the Volstat division of Advance Electronics. They have been specifically designed to meet the requirements of integrated circuit technology, with particular reference to reliability, and they incorporate a new protection circuit to safeguard both the power supply and the load. Stability of 10,000 to 1 is claimed, and under the

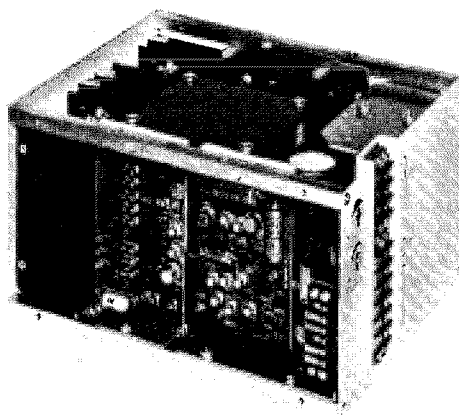

worst conditions of maximum temperature output voltage and current, the estimated m.t.b.f. is given as not less than 30,000 hours. Advance Electronics Ltd., Hainault, Essex.

**WW 318 for further details**

## I.C. Operational Amplifiers

Extremely high input impedance with very low offset current and input bias current are features claimed by Transistron for two new integrated circuit operational amplifiers, type TOA7709 (for the military temperature range  $-55^{\circ}\text{C}$  to  $+125^{\circ}\text{C}$ ) and type TOA8709 (commercial  $0^{\circ}\text{C}$  to  $70^{\circ}\text{C}$  range). These devices are compatible with the TOA1709 and TOA2709, both in pin configuration and compensating circuitry. The exceptional input characteristics effectively eliminate bias current and offset current as an error source, and allow the use of high impedance levels in circuit designs. The TOA7709 features  $3\text{M}\Omega$  minimum input impedance (typically  $10\text{M}\Omega$ ), input bias current of  $10\text{nA}$  maximum, and the TOA8709 a minimum input impedance of  $1\text{M}\Omega$  ( $3\text{M}\Omega$  typical); input bias current of  $60\text{nA}$  and input offset current of  $20\text{nA}$  maximum. Both are available in dual in-line packs, flat packs and TO99 cans. Transistron Electronic Ltd, Gardner Road, Maidenhead, Berks.

**WW 342 for further details**

## Polycarbonate Film Capacitors

Mullard has recently added a range of polycarbonate film capacitors to its 344 series. The new additions are 100V type capacitors with pin connections designed for direct insertion into the 0.1in grid of a printed circuit board. The regular rectangular outline of the capacitors permits high packing densities. With capacitance values of 0.68 to  $6.8\mu\text{F}$ , the new range complements the 0.01 to  $2.2\mu\text{F}$  coverage provided by the popular 250V range. Because of their lower working voltage the new types are physically smaller; for example a  $0.1\mu\text{F}$  in the 100V range is the same size as a 250V  $0.01\mu\text{F}$ . Special features of the 100V range are: low loss ( $\tan \delta \approx 30 \times 10^{-4}$ ) and long term stability with a d.c. load (change of capacitance is less than 1.5% at  $2.5^{\circ}\text{C}$ ). Mullard Ltd, Mullard House, Torrington Place, London, W.C.1.

**WW 343 for further details**

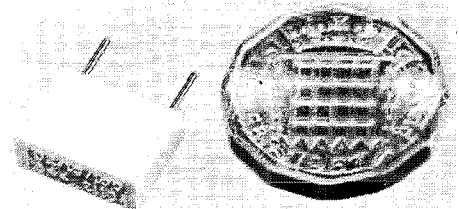

## Integrating Millivoltmeter

Suitable for both instantaneous and time-integrated (averaged) voltage measurement, a dual purpose millivoltmeter by Time Electronics, a new company, uses an f.e.t. chopper stabilized amplifier operated in a negative feedback mode. An input resistance of  $1\text{M}\Omega$  is maintained throughout the entire range of  $1\text{mV}$  to  $30\text{V}$ . The integrator section employs the amplifier in an error-correcting feedback integrator circuit and the time integral is displayed on a  $180^{\circ}$ , 5" mirror scale meter, zero to f.s.d. representing  $36\text{mV/sec}$  ( $1/100\text{mV/hr}$ ) for the  $\text{mV/hr}$  range, and  $36\text{V/sec}$  ( $1/100\text{V/hr}$ ) for the  $\text{V/hr}$  range. A 6-digit magnetic counter is used to total these units of integral by advancing one count each time the meter reaches f.s.d. The mean value of the input voltage over a given period is then determined by dividing the number of counts during the period by  $100 \times$  period in hours, the result being in  $\text{mV}$  or  $\text{V}$  depending on the selected range. The integrator output and count

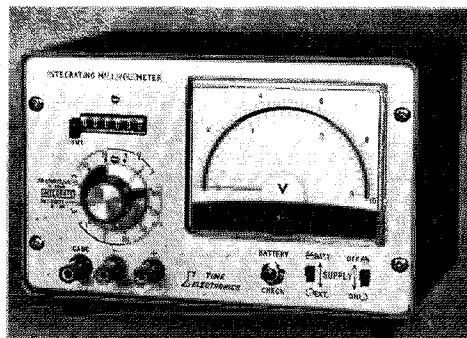

command are available at the rear of the instrument for driving external equipment. Dimensions  $20 \times 13 \times 13\text{cm}$ ; price  $\pounds 98$ . Time Electronics, 10B High Street, Swanley, Kent.

**WW344 for further details**

## Video Tape Splicer

Increased use of video tape recorders using  $\frac{1}{2}$ in. magnetic tape has led to the introduction of a new  $\frac{1}{2}$ in. splicer by Multicore Solders, based on the well-known Bib splicer for  $\frac{1}{4}$ in. tapes. Model 21 splicer enables diagonal or butt joints to be made. The recommended retail price of the splicer which



is packed in a kit with six razor cutters, a reel of splicing tape and a Bib size E tape head maintenance kit, is  $\pounds 10$ s. Multicore Solders Ltd., Maylands Avenue, Hemel Hempstead, Herts.

**WW 311 for further details**

## Linear Microcircuit

A fully integrated low-cost differential amplifier is the latest linear microcircuit, the  $\mu\text{A}730$ , from SGS-Fairchild. It is designed to replace two discrete dual-transistors as a gain block in general purpose a.c. and d.c. applications. Encased in a low profile 8-lead TO-5 can, the new device has an input offset voltage of  $2.5\text{mV}$  maximum and an input-offset current of  $500\text{nA}$ . Common mode rejection ratio is 70dB minimum, differential voltage gain is 145. Any combination of single-ended or differential configurations can be employed at its input and output, making the  $\mu\text{A}730$  suitable for use as a voltage comparator, a phase splitter, level detector, voltage regulator or a push-pull amplifier. Other uses include preamplifiers for sensing; magnetic tape, audio summing and instrument amplifiers; voltmeters and transducers. SGS-Fairchild Ltd., Planar House, Walton Street, Aylesbury, Bucks.

**WW 345 for further details**

# High-frequency Analogue Multiplier

## Quarter-square Circuit Operates at Megahertz

by M. E. Whatton, A.M.I.E.E., and G. Crisp

**D**URING an investigation into a colour television system<sup>1,2</sup> it was necessary, as part of the process of decoding, to devise a method of multiplying together the two received colour subcarrier signals. A known technique for achieving this is the use of a balanced or ring modulator, and successful multipliers were built using this technique.

Circuits for multiplication are, however, well known in the analogue computer field, and it was thought that an investigation into the possibilities of using such circuits would prove useful. This article shows the techniques used and describes a suitable multiplier. The colour subcarrier frequency was 4.43MHz and the unit constructed had a bandwidth of about  $\pm 1.5$ MHz. The multiplier was based on the "quarter-square" multiplier which has been successfully used in analogue computer techniques<sup>3</sup>.

The reason for the name "quarter-square" multiplier is as follows. If it is desired to multiply together two voltages  $V_1$  and  $V_2$ , then this may be carried out as shown below:—

$$\begin{aligned} (V_1 + V_2)^2 &= V_1^2 + 2V_1V_2 + V_2^2 \\ (V_1 - V_2)^2 &= V_1^2 - 2V_1V_2 + V_2^2 \end{aligned}$$

$$\therefore (V_1 + V_2)^2 - (V_1 - V_2)^2 = 4V_1V_2 \dots (1)$$

Thus to obtain the required term  $V_1V_2$ , it is necessary to perform the squaring and other operations on  $V_1$  and  $V_2$  as shown on the left-hand side of equation (1) and then divide the resultant answer by four. Hence the term "quarter-square".

The component parts of the multiplier are therefore:

- An adder to produce  $(V_1 + V_2)$  and  $(V_1 - V_2)$
- Two square-law devices
- A difference amplifier

A block schematic of the multiplier is shown in Fig. 1. As the particular square-law device used requires "push-pull" input signals these are also provided by the adding network.

*M. E. Whatton joined the B.B.C. operations and maintenance department from Cinema-Television Ltd. in 1947 after qualifying at the South East London Technical College. In 1952 he transferred to the designs department and is now in the television studio section.*

*Graham Crisp, who is 23, joined the B.B.C. in 1963 as a technical assistant in the transmitter operations and maintenance department. He went to the designs department in 1965 and is now in the television measurements section.*

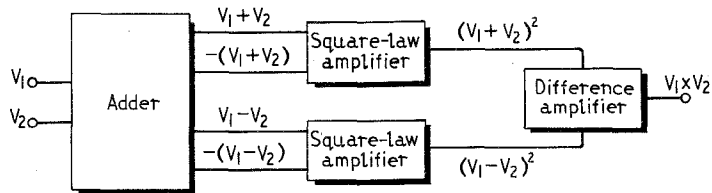

Fig. 1. Schematic showing principle of operation of the quarter-square multiplier.

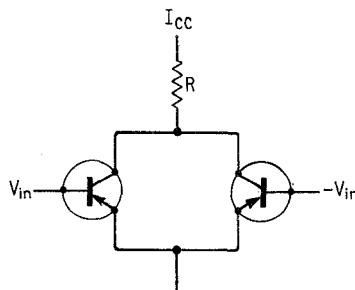

Fig. 2. Circuit for obtaining square-law function of input,  $V_{in}$ .

### The Square-law Unit

A simple square-law device<sup>4</sup> was developed which consisted of two transistors feeding a common collector load as shown in Fig. 2.

The collector current/base voltage curve of either transistor may be represented by the following equation:

$$I_c = a + bV_{be} + cV_{be}^2 + dV_{be}^3$$

where  $a$ ,  $b$ ,  $c$  and  $d$  are constants.

Therefore

$$I_{c1} = a + bV_{in} + cV_{in}^2 + dV_{in}^3$$

$$I_{c2} = a - bV_{in} + cV_{in}^2 - dV_{in}^3$$

Then the total current

$$I_{cc} = 2a + 2cV_{in}^2$$

The first term is a constant and the remaining term is proportional to the square of the input voltage. Therefore the change in output voltage is proportional to the square of the change in input voltage.

### Circuit description

The circuit of the multiplier is shown in Fig. 5. The two high-frequency signals  $V_1$  and  $V_2$  are applied to two broadband r.f. transformers  $T_1$  and  $T_2$ . These transformers have a centre-tapped secondary winding which is bifilar wound. Transformer  $T_1$  produces two signals  $V_1$  and  $-V_1$  across its secondary winding and transformer  $T_2$

produces  $V_2$  and  $-V_2$  across its output. These signals are combined in simple resistive adders  $R_1$  to  $R_8$  to produce the four signals,  $(V_1 + V_2)$ ,  $-(V_1 + V_2)$ ,  $(V_1 - V_2)$  and  $-(V_1 - V_2)$ . These four signals are phased by the split-stator capacitors  $C_5$  and  $C_6$ .

As the square-law transistors are voltage operated it is necessary for these to be driven from low impedance sources. These are provided by the emitter followers  $Tr_1$ ,  $Tr_4$ ,  $Tr_5$  and  $Tr_8$ . The square-law transistors  $Tr_2$  and  $Tr_3$  are balanced by the network  $R_{13}$ ,  $R_{15}$  and  $R_{16}$ . In a similar way transistors  $Tr_6$  and  $Tr_7$  are balanced by the network  $R_{25}$ ,  $R_{27}$  and  $R_{28}$ .

The signal at the collectors of  $Tr_2$ ,  $Tr_3$  is then  $(V_1 + V_2)^2$  and at the collectors of  $Tr_6$ ,  $Tr_7$  is  $(V_1 - V_2)^2$ . These two signals are applied through emitter followers  $Tr_9$ ,  $Tr_{10}$  to a simple difference amplifier  $Tr_{11}$ .

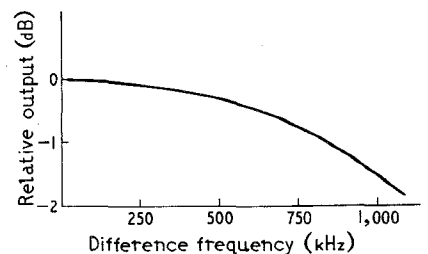

Fig. 3. Frequency response of the multiplier.

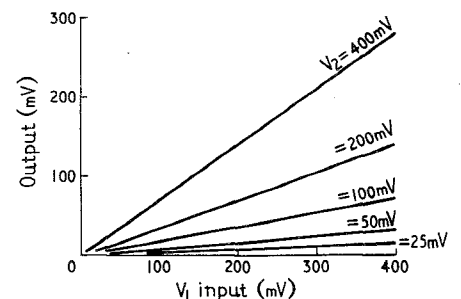

Fig. 4. Input/output characteristic of the multiplier.



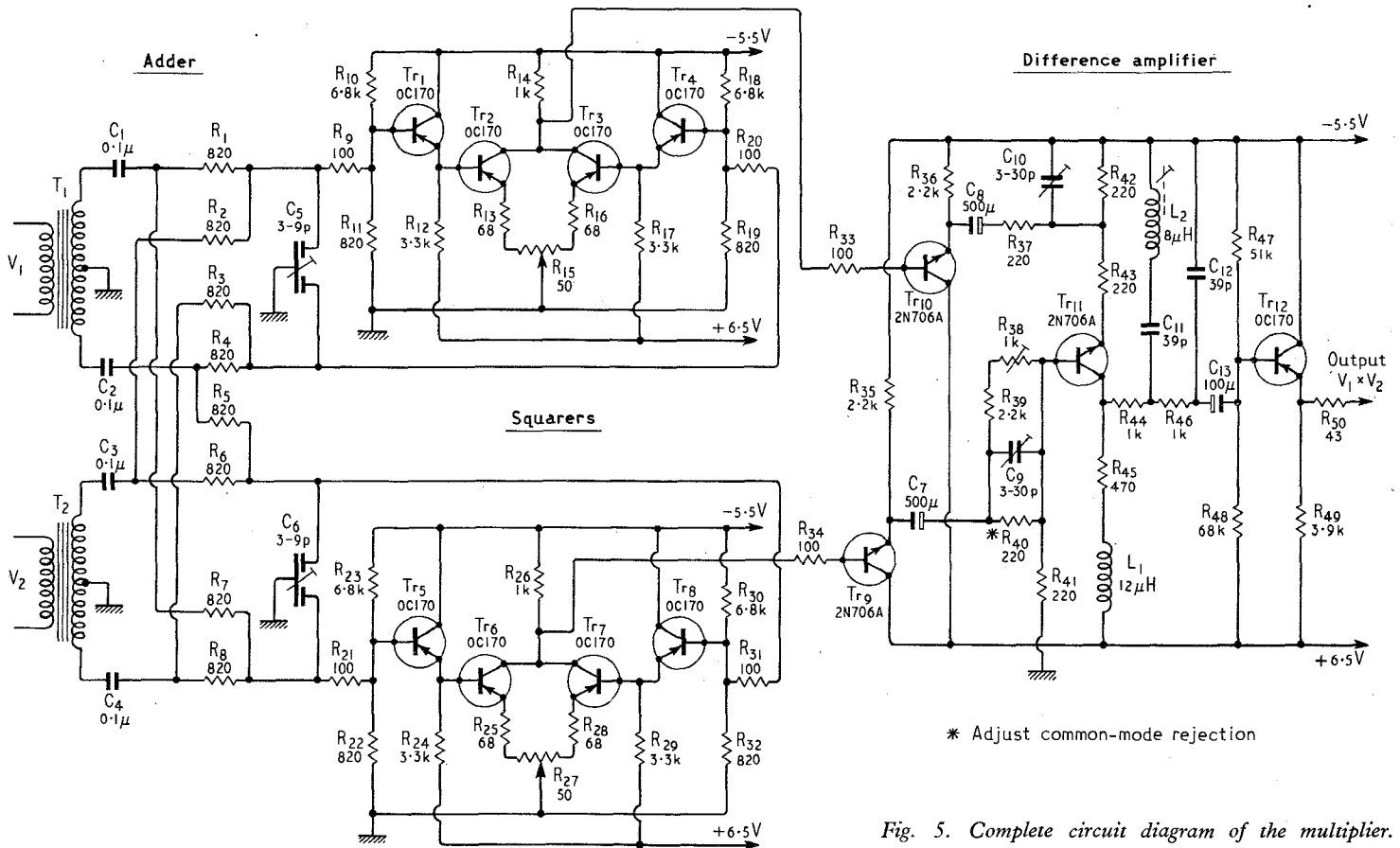

Fig. 5. Complete circuit diagram of the multiplier.

The common mode rejection of this amplifier is adjusted at low frequencies by  $R_{40}$  and  $R_{38}$  and at high frequencies by  $C_9$  and  $C_{10}$ .

The output signal from  $Tr_{11}$  consists of two parts: the first is the required output signal and the second is a high frequency

component at approximately twice input frequency. This high frequency component is removed from the output by the networks  $R_{44}$ ,  $C_{11}$ ,  $L_2$  and the network  $R_{46}$ ,  $C_{12}$ . The signal is then fed to the output through the emitter follower  $Tr_{12}$ .

Fig. 3 shows the frequency response of the unit, and this is about 1.5 dB down at 1MHz. Fig. 4 shows the input/output characteristics for  $V_1$  and  $V_2$ . This is linear over a range of 23dB for each input. Fig. 6 shows the output waveforms for output frequencies of 200kHz and 1MHz both above and below 4.43MHz.

Fig. 6. Output waveforms for output frequencies 200kHz and 1MHz above and below 4.43MHz.

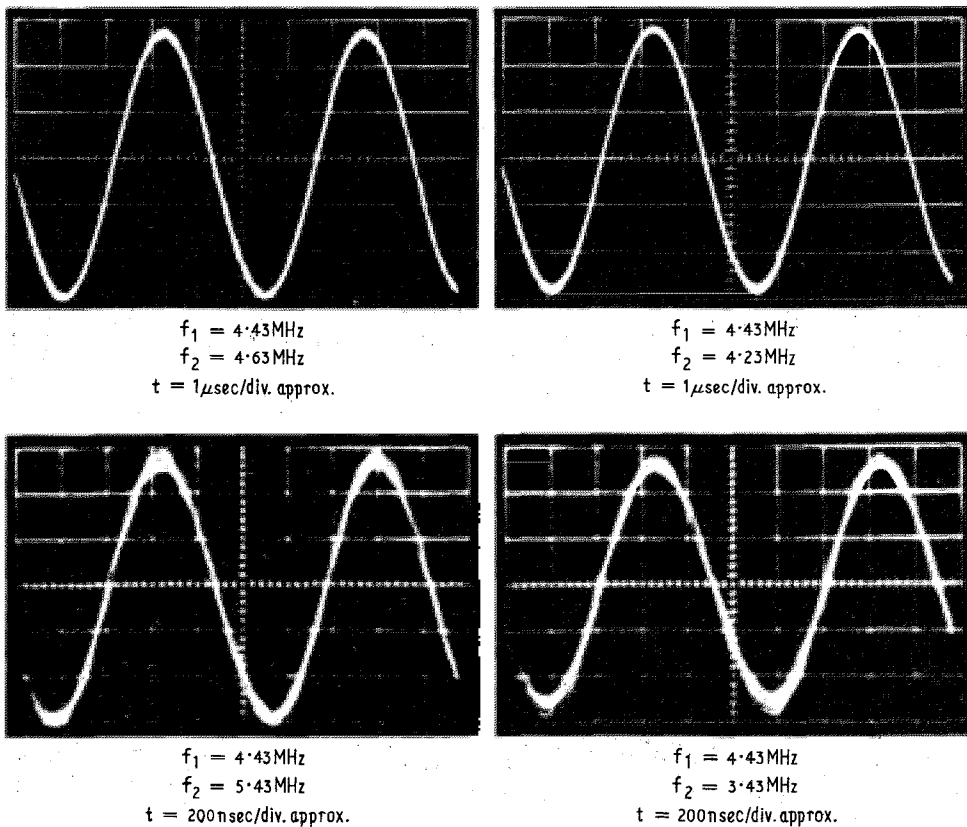

## Conclusion

The investigation showed that a quarter-square multiplier could be built and used at colour sub-carrier frequencies. In such a multiplier, the input/output characteristics were very linear for a wide range of inputs and the frequency response adequate.

In the circuit as described no attempt has been made to design an economical unit and the circuit was built only to investigate the techniques required. As over half of the transistors were used as emitter followers it seems that some of these could be eliminated in any practical application.

The authors would like to thank the Director of Engineering of the B.B.C. for permission to publish this article and also many of their colleagues in Designs Department for their assistance.

## References

1. The NIR system. See "From Russia with Love", *Wireless World*, February 1966, p. 73.
2. *ibid.* "B.B.C. Man Anticipates Russian Colour TV System?", p. 75.
3. "Waveforms" by Chance, Hughes, MacNichol, Sayre and Williams. McGraw-Hill Book Company, New York (1949), Section 19.2, p. 668.
4. *ibid.* Section 19.7, p. 683.

# World of Amateur Radio

## R.A.F. Golden Jubilee Year

A celebration dinner organized by the R.A.F. Amateur Radio Society to mark the 50th Anniversary Year of the Royal Air Force will be held at No. 1 Radio School, R.A.F. Locking, near Weston-super-Mare, on Saturday, July 6th. Activities will commence at 13.30 hours. Provisional plans for the day include a display of historical wireless equipment and visits to the Headquarters station and to selected training laboratories at the Radio School. There will also be a mobile frequency measuring contest and a mobile field strength contest. Talk-in stations will operate on 160 and 2 metres. Entertainment will be provided for the ladies and children.

The celebration dinner will be held in the Grand Atlantic Hotel, Weston-super-Mare. Dress will be informal and the charge for the dinner will be £1.11.6. Applications should be sent to reach the Treasurer, R.A.F.A.R.S., Royal Air Force, Locking, Weston-super-Mare, Somerset, by mid-June.

## England-France on 13cm

For the first time, on February 18th, French and British radio amateurs succeeded in establishing communication across the English Channel on 13 cm (2350 MHz). The distance covered was 35 km the stations being located at Cap Blanc-Nez (15 km west of Calais) and on cliffs near Dover Castle. At the French station (F2F0/P) a 2C39 was pulse-modulated at 200 Hz delivering 1kW peak output at 2350 MHz to a one-foot dish 400 feet above sea level. The English station (G3RPE/P) used two transmitters. One had a DET22 self-excited oscillator with transistor modulator (input 8 watts and A3 output of 300mW at 2320MHz). The other had a self-excited oscillator/amplifier using specially-made experimental transistors. The output was chopped 1kHz, the input was 2.5 watts and the mean output power was 400mW. On the receiving side a crystal-controlled convertor (2350-2352 MHz) fed a narrow-band (4 kHz) tunable transistor i.f. strip. The aerial was a 4-ft dish, mounted 8ft above ground on a site about 350ft above sea level.

This amateur "first" came 37 years after the first public demonstration of what was then called "micro-ray" communication between Dover and Calais on 17cm and 35 years after a commercial radio link on 17cm was established between Lympne, Kent, and St. Inglevert, France.

**International Mobile Meeting.** The annual international meeting organized by the Amateur Radio Mobile Society will take place on Sunday, June 30th, at the United States Air Force Base, R.A.F. Mildenhall, Suffolk. Camping and caravanning will be permitted from the Friday evening. The Trade Show (a feature of A.R.M.S. Mobile Meetings) is to be accommodated in an aircraft hangar and the organizer (F. J. Barns, G3AGP, 60 Alverstone Avenue, New Barnet, Herts) will be pleased to receive enquiries from firms or organizations who wish to participate. The secretary of A.R.M.S. is Norman Fitch, G3FPK, 79 Murchison Road, Leyton, London, E.10.

**Echo of the Q.M.** At an informal ceremony at the U.S. Embassy in London, Mr. Eric Godsmark of the Radio and Broadcasting Department of the Post Office recently received a certificate and plaque from the radio amateurs of Long Beach, California in appreciation of the services he rendered to those U.S. amateurs who were authorized by the U.K. Postmaster-General to operate a station on the *Queen Mary* during her last transatlantic voyage. Mr. Godsmark organized arrangements for a special amateur licence and call-sign (GB5QM/MM) which enabled American radio amateurs from California to contact, from the Q.M., other licensed amateurs throughout the world.

**Morse Proficiency Transmissions.** The Royal Naval Amateur Radio Society located at H.M.S. *Mercury*, Leydene, Petersfield, Hampshire, transmits morse code proficiency runs on 3520 kHz at 19.00 G.M.T. on the first Tuesday in each month at speeds of 20, 25, 30, 35 and 40 words per minute. A proficiency certificate is issued for 100% copy of a particular speed. The transmissions are made from the Headquarters' station G3BZU which also operates daily on 7010 kHz  $\pm$  5kHz between 11.00 and 12.00 G.M.T. Claims for code proficiency certificates should be sent to the above address enclosing an I.R.C.

**Swedish V.H.F. Beacon.** A new v.h.f. beacon is now operating on 145.960 MHz from Spansberget, near Borlange, in Central Sweden. The main purpose of the beacon is to produce a signal for the aurora back-scatter investigations which are being carried out at the Max-Planck Institute, Lindau,

Germany, by Dr. G. Lange-Hesse, DJ2BC. The establishment of the beacon station was made possible by close co-operation between the Swedish Telecommunication Authorities and the Swedish national amateur radio society (S.S.A.). The call-sign of the beacon is SM4MPI transmitted once a minute followed by a 50-second dash. The aerial consists of four 5-element arrays and has a gain of about 12dB. The beam is directed through 325°. Power output is around 100 watts and although the array is only 12 metres (40 ft) high the base of the mast is almost 500 metres (1650 ft) above sea level. The exact location of the beacon is N 60° 22', 58", E 15° 08' 30". Reports on signals from the beacon will be appreciated by G. Eriksson, Box 12, Falun 1, or by the S.S.A., Fack, Enskede 7, Sweden. One of the most important items of information to be included in a report is whether or not the signal was received via aurora back-scatter or by direct path.

**U.H.F. Call-sign Directory.** The first edition of a new directory of amateur radio stations active on 220 MHz and higher frequency bands is now available from the headquarters of the American Radio Relay League, 225 Main Street, Newington, Connecticut, 06111, U.S.A. The directory lists the name and address of each operator together with information about his interests in such diverse fields as meteor scatter, moonbounce and OSCAR reporting. Information is also given on aerial systems in use. A copy of the directory may be obtained from the above address by sending a large self-addressed envelope and four I.R.Cs.

**German Training Courses.** The outstanding success of the intensive training courses for prospective radio amateurs organized last year by the German national amateur radio society (D.A.R.C.) has prompted that organization to offer a more extensive programme for 1968 and at the same time to invite participation from foreign students who can speak or read German. The following is a list of the dates of this year's summer holiday courses:

July 21-August 7 South Bavaria.

July 25-August 14 Wurtemberg.

July 28-August 13 Lower Saxony.

August 1-21 Silesia-Holstein.

August 4-21 Hestia.

Further details of the training courses can be obtained from H. J. Henske (DL1JH), 605 Offenbach/Main, Wiesenstrasse 21.

**Knokke Convention.** The 4th International Amateur Radio Convention organized by a group of Belgium Channel-coast amateurs is to be held in the Casino, Knokke, during the weekend September 13th-15th. Details of the programme can be obtained from Lucien Vervarcke (ON4LV), Lippenslaan 284, Knokke 1, Belgium.

**R.N.A.R.S.** During the Lee-on-Solent Air Day on June 15th, the Royal Naval Amateur Radio Society will be providing talk-in facilities on 1910kHz, 70.26MHz and 145.3MHz. Callsign GB3RN.

JOHN CLARRICOTS G6CL

# Answers to "Test Your Knowledge"—1

Questions on page 161

1. (c). Both junctions may become forward biased when a transistor is used in a switching circuit.

2. (c). Only carriers injected from emitter into base take part in transistor action. Hence the emitter current must consist as largely as possible of carriers moving in that direction. In a forward biased p-n junction, currents carried by holes moving from p to n and electrons from n to p depend upon the relative doping of the two sides. The carriers when injected into the base become minority carriers. The relatively large equilibrium population of minority carriers in the base (because of low doping) has no effect on the action.

3. (c). The transit time of the injected carriers from emitter to collector must be short compared to the minority carrier lifetime in the base material.

4. (c).  $\alpha$  is the product of "injection ratio", "base transport factor" and "collector multiplication factor".

5. (c). The collector-base junction depletion layer increases in width, thus reducing the distance through which the carriers must move before they are swept into the collector.

6. (b). The purpose is to make the transit time of carriers in the base short, to produce a device with good high frequency performance.

7. (b). The diffusion method of doping must leave doping gradients in the material. Silicon planar transistors of p-n-p type are made; n-p-n are more common. A silicon planar transistor cannot be symmetrical.

8. (a) The net charge in the base must remain zero, so that extra electrons will be drawn in through the base lead, when the current starts, to compensate for the extra holes injected.

9. (c). If the junction were forward biased a current would flow between gate and channel and the input impedance would be lowered.

10. (d). In normal use the polarity of the drain voltage is such that the gate-channel voltage is greatest near the drain. Hence at this point the depletion layer is widest and the channel narrowest.

11. (c). It extends completely across the channel at the drain end. If the drain voltage is increased above the value at which this occurs an increasing length of the channel is blocked in this way.

12. (b). In an enhancement m.o.s.t. the channel is formed by applying a voltage to the gate that attracts minority carriers to the surface under the insulation and thus induces a channel of the opposite type to that of the bulk material.

13. (b).

14. (a). A depletion m.o.s.t. has very similar properties to those of a junction f.e.t. Its input impedance, however, is higher.

15. (d). In regard to factors (a), (b) and (c), m.o.s.t.s are no worse than other transistors.

16. (b). In regard to factors (a), (c) and (d), f.e.t.s are at least no better than bipolar transistors.

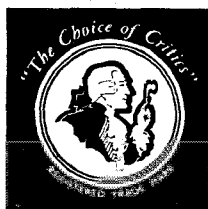

THE HOUSE OF BULGIN  
AT YOUR SERVICE

## UNIQUE NEW DEVELOPMENTS AS SHOWN AT THE I.E.A. EXHIBITION

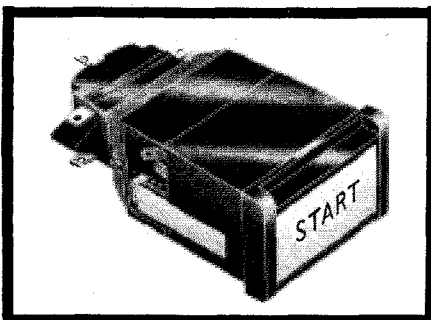

### SWITCHED ILLUMINATED INDICATORS

Dev't. No. 1037

An attractive legended button unit of moulded construction lit by two low voltage L.E.S. lamps in combination with mains rated switching which can be either D.P.C.O. Push/Push (Successional) action or from 1 to 4 pole Make and Break or Change Over biased action. Legending to customers own requirements which can be carried out over the full Filter area or split into two independently lit sections, left and right, with light separation barrier between.

### 8-POLE MAINS CONNECTOR

List No. P.550

A versatile 7 pole + earth connector rated 6A, 250V. A.C. with both members designed so that when un-mated live parts are shrouded and safe to handle thus enabling use for both mains inlet and outlet applications. Of rugged all moulded plastic construction with positive keying which prevents reversed insertion. The Plug has Screw Terminal connections, and the Socket tags, accepting 187 series push-on tabs.

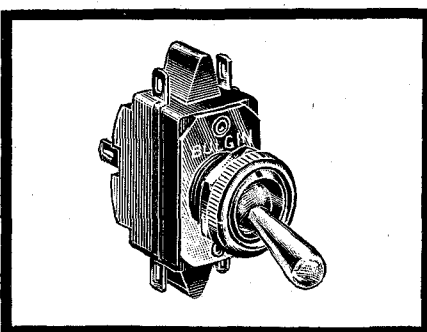
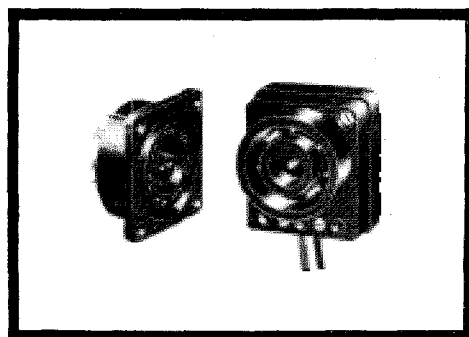

### RANGE OF MOULDED SWITCHES

List No. S.270/2 (Toggle operated)

A new range of D.P.C.O. panel mounting Switches of moulded construction with Quick Make & Break action and self-cleaning silver contacts. Equally suitable for 'mains' or 'low voltage' uses. The range which is to be extended later this year will include various forms of actuation, i.e. Toggle, Biased Toggle, Push Button, Push On/Push Off (Successional Action), Semi-Rotary, & Key.

### PANEL MOUNTING BATTERY HOLDERS

List Nos. B.16 (one cell), B.17 (two cells)

A pair of Battery Holders accepting one (List No. B.16) or two (List No. B.17) U.2 cells. Both models have polished black front of panel parts with the front cap legended BATTERY which fixes by a push and twist action with Key Slot removal. Four 6BA. bolts fix the units to the panel and the cable connection is by tags accepting solder or 187 series push-on connectors. This range is to be extended later this year by models accepting three and four U.2 cells—enquiries invited.

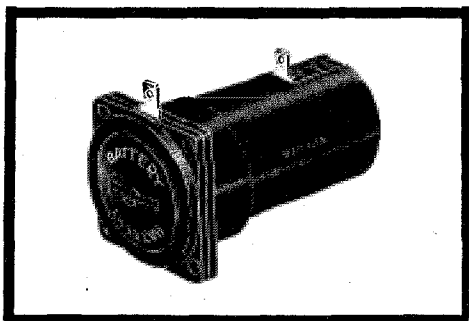

FOR DETAILS OF THESE AND MANY OTHER NEW LINES  
SEND FOR I.E.A. PRESS RELEASE

A. F. BULGIN & CO. LTD.,  
Bye Pass Rd., Barking, Essex.  
Tel: RIPpleway 5588 (12 lines)

MANUFACTURERS AND SUPPLIERS OF RADIO  
AND ELECTRONIC COMPONENTS TO

ARMY	MINISTRY OF WORKS	R.F.C.
NAVY	MINISTRY OF AIRCRAFT	R.P.O.
R.I.C.	MINISTRY OF SUPPLY	S.T.A.
HOME OFFICE	RESEARCH ESTABLISHMENTS	M.P.L.
SCREW AGENTS	U.A.R.A.	M.S.B.

# Literature Received

Second editions of the numbers one and two handbooks, "Services for British Exporters" and "ECGD Credit Insurance and Financial Support Services" are now available from any Board of Trade regional office or the U.K. Publicity Section, Information Division, Board of Trade, 1 Victoria St., London, S.W.1. "Services for British Exporters" presents comprehensive information on the whole range of Government and other export services and explains, in 180 pages, how exporters can best benefit from them. The "ECGD Credit Insurance and Financial Support Services" handbook describes the facilities provided by the Exports Credit Guarantee Department.

WW401 for further details

**Display Devices.** The display department of Ferranti Ltd, Gem Mill, Chadderton, Oldham, Lancs., have produced an eighteen-page brochure describing some of their products. Included are the essential electrical characteristics of the Microspot range of cathode-ray tubes with suggested applications, the types, and properties of the various phosphors available are also outlined. Details of other devices from custom built display equipments, including coils, flash tubes, trigger tubes (arc discharge and thyratron) to pulse transformers are included.

WW402 for further details

Now available from SASCO, P.O. Box 20, Gatwick Rd., Crawley, Sussex, the latest edition of their **components catalogue**.

WW403 for further details

"Don't Trip Up" is the title of a leaflet describing **rubber conduit strip** which is designed to protect loose cables and wires, and staff from injury. Vulcasot Ltd., Acorn House, Victoria Road, London W.3.

WW415 for further details

An adaptor that converts a standard b.n.c. input terminal on test equipment to a twin 4mm outlet, and also cylindrical coaxial terminated metal cases for packaging test circuits (voltage dividers, attenuators etc.) are described in a leaflet from Radial Microwave Components Ltd., Station Approach, Grove Park Road, Chiswick, London W.4.

WW416 for further details

"What to Look for When You Buy a Car Radio" is the rather misleading title of a new booklet from Philips. It does not give technical advice to those about to choose a car radio as the title suggests, but describes the range of Philips car radios and gives details of which accessory kit is required for particular types of car, together with a full price list. Philips Electrical Ltd., Century House, Shaftesbury Avenue, London W.C.2.

WW417 for further details

The "Abridged Valve Data Book" summarizes the range of valves available from the English Electric Valve Company, Chelmsford, Essex. The book incorporates a thumb indexing system and is divided into three major groups. These are power, microwave and light conversion applications, with a final subsidiary group listing such products as lasers, cold-cathode tubes and vacuum capacitors.

WW418 for further details

"A Comprehensive Catalog and Guide to Operational Amplifiers" contains 36 pages of advice, data and product information relating to equipment manufactured by Analog Devices, Inc., 221 Fifth St., Cambridge, Mass. 02142, U.S.A.

WW419 for further information

Rather belatedly we bring readers' attention to the new **components catalogue** produced by Home Radio Ltd., 187 London Road, Mitcham, Surrey, costing 7s 6d plus 2s postage. The catalogue has 256 pages and lists over 7,000 items, 1,300 of them being illustrated. As is their usual practice the catalogue includes five vouchers worth 1s each.

BS 3363:1968, which is concerned with **letter symbols for semiconductor devices**, is now available and can be obtained from the British Standards Institution, 2 Park St., London W.1, price 12s.

We have received a copy of the **British Amateur Electronics Club Newsletter**. This describes in some detail the logic of a noughts and crosses computer being produced as a B.A.E.C. project. Among the other items incorporated is a description of a unit capable of demonstrating the operation of a colour TV tube. The chairman of the club and editor of the newsletter is Mr. C. Bogod, "Diebeus", 26 Forest Road, Penarth, Glam.

WW413 for further details

**Waveguide switches** are described in a 15-page brochure available from Silvers Lab., Stockholm 42, Sweden.

WW407 for further details

"A Pocket Guide to Semiconductors" is the title of a pocket book produced by Quarndon Electronics (Semiconductors) Ltd., Slack Lane, Derby, which gives prices and data on a variety of transistors, diodes and integrated circuits available from them. Quarndon are distributors for Texas Instruments, SGS-Fairchild, Transistor A.G., Emihus, Tadican, and Sprague.

WW404 for further details

A 15A a.c. **constant voltage regulator** with an accuracy of 0.3% and introducing only 3.5% distortion is described in a leaflet from Claude Lyons Ltd., Valley Works, Hoddesdon, Herts. The regulator, weighing 18lb, has a time constant of 0.1sec and does not employ any form of filtering to achieve the low distortion level.

WW405 for further details

## H.F. Predictions—June

The curves, drawn by Cable & Wireless Ltd., show median standard MUF, optimum traffic frequency (FOT) and lowest usable frequency (LUF), the latter being for reception in the U.K. of medium-power commercial telegraphy transmitters using high-gain aerials. The LUFs by their relative proximity to FOTs, are a guide for all types of service.

Predictions are based on an Ionospheric Index (IF2) of 134 which is expected to be the current cycle maximum. Ionospheric and magnetic disturbances of the type which can last for several days reach peak intensity in the few years following sunspot maximum. As such disturbances have been at low level for some time serious interruptions are not expected.

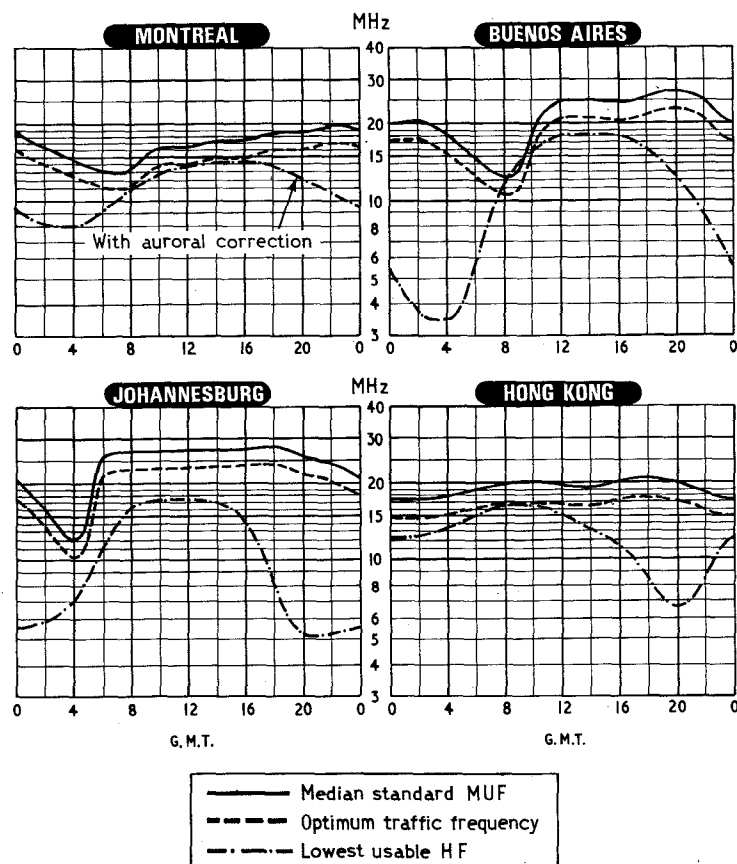

# WH CONTIL AND PIDAM SYSTEMS

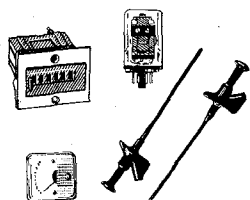

## ACCESSORIES

A full range of accessories are available for PIDAM. Shown are the meter, scaled 0-9, at 35/6. Test prods insulated and flexible with fine steel clips at the tip, red or black at 13/-. High speed resetting counter including bezel and socket, with speed of over 40 operations per sec. 165/-. Plug-in Octal relay 24v. with two changeover at 17/6. Not shown. 8 range test meter, 45/-. Oscilloscope made for us by Advance, £25.

**PIDAM** (Plug-in Digital and Analogue Modules) perform all the usual logic functions, but, unlike other units, can be plugged in, using their B9A bases and can be quickly connected to the required configuration. To help learning, the module covers are easily removable for circuit examination and sets of components are available. The 16 modules have an enormous range of use, from a single MONO for a tachometer, to over 300 units in a computer interface; nevertheless, their greatest asset is extreme simplicity. Design time is cut and elaborate breadboards superseded and any reader of "Wireless World" could with **PIDAM**, build up a low cost system for his own needs.

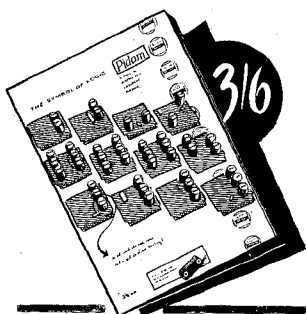

## PIDAM BROCHURE

Send for this complete explanatory booklet showing detailed examples of use and circuit diagrams of all modules. Examples and circuits given include voice-operated switch alarms, flashers, tachometer, timers, batch counters, etc. 3/6 post free.

## PIDAM PLUG-IN MODULES, PRICES

per module range from 9/6 to 28/- and all necessary accessories are supplied. A complete starting kit is only £20/19/6 (normally £23/12/6).

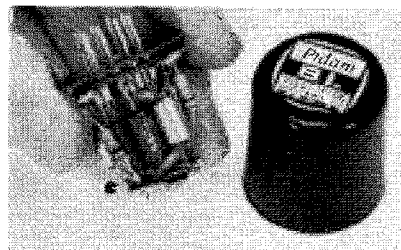

**B1** (Bistable) module shows B9A base for ease of connection. Pins 7, 8, 9 are always power connections.

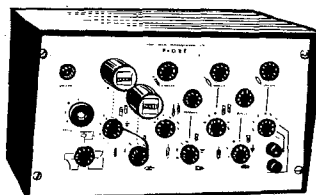

## PIDEc

(Plug-in Digital Educational Circuit). This Pidec unit allows seven modules to be interconnected for demonstration or mock-up without soldering. Including internal power supplies, 370/-.

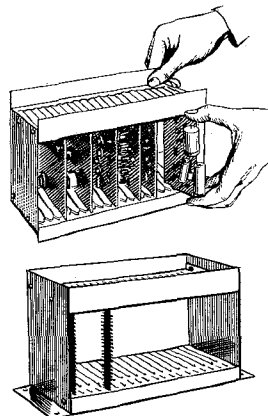

## PRINTED CIRCUIT CHASSIS

Printed circuit chassis type "P" which fits into 1277 or 16127 case, or type "Q" which can be mounted on an aluminium chassis. Both types take up to 20 boards and connectors on 1/2 in. centres. Prices from 45/6 down to 37/- for quantities.

## CONTIL CASES

Contil cases are mass-produced to give the lowest prices yet. In 21-gauge steel. Finished hammer blue, with 18-gauge front panel supplied with easy-to-strip protective covering for easy marking out. For ease of ordering Contil cases are described by their dimensions, i.e. 755 is 7x5x5in. Individually packed, inc. feet and screws.

Range of chromium-plated and Delrin handles available with matching chassis, spare panels, etc.

	ONE	FIVE
755	45/6	44/-
867 or 975	47/6	46/-
1277	53/-	51/-
16127	98/6	96/6
191010	133/-	130/-
Kit	£11/19/-	(normally £14/12/-)

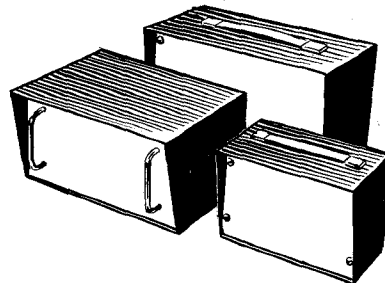

## DIGITAL COMPUTER MODULES

Digital computer modules are available including bistables flip flops comparators (coincidence gate) neon driver 5NOR 2NOR x2 5NAND, and RESET. Also available are neons for drive by transistors, display boards, divide boards, together with escutcheons that only require round holes.

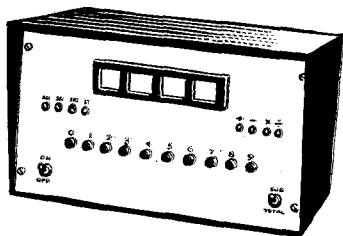

## DIVIDE BOARD

The Contil divide board can be used for decoding from 9 bistables giving a count up to 512. Includes resetting and decoding diodes and switches. Type "R" at 78/- each.

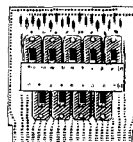

"A" board shows plugged into "M" 20-way connector with "S" board supports. Note: Power supply rails at right angles to signal rails "A" boards 8/6 each. 20-way "M" connector 9/- "S" supports 3/- pair. Less for quantities.

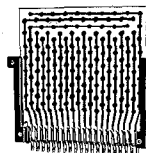

## TRANSFORMERS

Two West Hyde transformers are available for transistorised equipment, one at 2 amps giving 6, 10, 15, 18 and 30v i.e. 3, 4, 5, 6, 8, 9, 10, 12, 15, 18, 24 and 30 with 12-0-12 and 15-0-15. The second at 1 amp. 6, 10, 18v. taps. Price 37/6 and 26/-. Additional type available providing 2 amps as above and in addition supplies 100mA at 150, 80, 0, 80, 150 volts to supply indicator tubes, etc. Price 50/-.

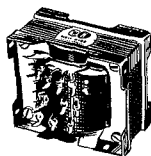

## REED SWITCH

The West Hyde Reed Switch works at up to 2,000 times a second for more than fifty thousand million operations. Ideal for: over and under speed monitors, counting, timing, switching, rev counting, etc. Hermetically sealed and moulded. Prices from 14/- each to 8/- each per thousand.

We now supply Q-Max sheet metal punches in 1/4 in. sizes up to 1 1/4 in. and 1/2 in. sizes up to 2 in.

## "BRIGHTLIFE" NEONS

25,000 hr. average life with high intensity and resistor in housing; either 3/16 in. or 1/4 in. dia. Standard units 160-250v. with 6in. lead variants. 10 at 2/6 each with 10 different caps. In quantity down to 1/8 each. Neon only, down to 5/2d. each.

We now supply our standard neons in 110 volt nominal at the same prices.

## CONTIL LOW COST PRINTED CIRCUIT BOARDS

	ONE	TEN	FIFTY
Standard transistor board	8/6	7/6	7/-
Half board B9A	7/-	5/6	4/6
B7G or B9A boards inc. their four respective bases	9/6	8/6	8/-
Connectors, 20-way	9/-	8/6	8/-
10-way	5/-	4/6	4/-
"P" chassis to fit 1277 Contil	39/6	37/6	37/-
Printed circuit kit: including case, normally £14/8/6 for only £11/19/6.			

We now supply Brightlife Fluorescent Starter Switches direct in minimum quantities of 50 off for 50/- C.W.O. only. Quantity prices down to 7d. As supplied to leading manufacturers in large quantities.

## SUB-MINIATURE NEON



The smallest yet. Type "Q" overall dia. 1/16 in., length 1 1/8 in. with resistor for mains, S.A.E. Minimum order £1. 3/6 each. Minimum quantity 10. Down to 2/9 each.

## PLEASE NOTE

All products ex-stock for normal quantities. Return of post service. No S.A.E. Minimum order £1. Fully detailed leaflets available. All prices include postage and packing.

# WH WEST HYDE

## WEST HYDE DEVELOPMENTS LTD.

30 HIGH STREET, NORTHWOOD, MIDDLESEX

Tel: Northwood 24941

The new V51 helical range of MEC miniature wirewound potentiometers offers high resolution in very small size. 3, 5 & 10-turn units are available. Resistance values range from 220Ω 3-turn, resolution 0.262%, to 220K 10-turn, resolution 0.017%. 3-turn units have continuous power rating 0.25W, 5-turn 0.5W and 10-turn 1W at 70°C.

Sealed construction, proof against humidity, vibration, shock, altitude and acceleration to meet Def5011 severities. Prices from 28/- depending on quantity.

Miniature Electronic Components Ltd., St. Johns Woking Surrey Telephone Woking 63621

**3 1/8" dia.**

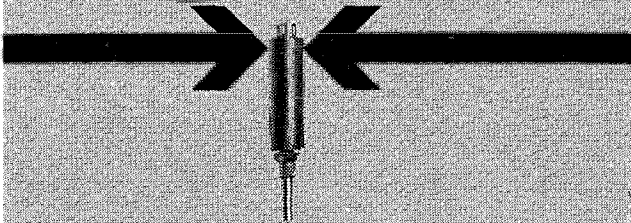

The smallest helical potentiometer available in UK.

**m-e-c**

Trimmer Potentiometers  
Wire-wound Resistors  
Miniature Switches  
Elapsed Time Meters

WW-105 FOR FURTHER DETAILS

**RTS**  
**by-return**  
**SERVICE**  
**ON**  
**WAYCOM**  
**COMPONENTS**

RTS are the officially appointed distributors for the following Waycom products.



**WIMA CAPACITORS**

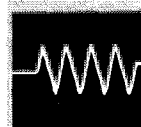

**W.P. SERIES CARBON FILM RESISTORS**

(tolerances: ±2%, ±5%)

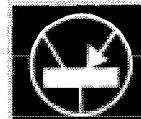

**EPOXY SILICON TRANSISTORS**

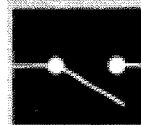

**MINIATURE SWITCHES**

(push-button, rotary, toggle)

In addition, the 150-page RTS Catalogue provides easy reference to a comprehensive selection of electronic components. *All are available 'by return'* and we will gladly send you a copy of the latest edition on request.

**RTS**

A DIVISION OF  
**COMBINED ELECTRONIC SERVICES LTD.**  
P.O. Box 11 · Gloucester Street · Cambridge.  
Tel: Cambridge (OCA3) 51471 — for orders  
Cambridge (OCA3) 59101 — other business

WW-106 FOR FURTHER DETAILS

# WIDELY ACCLAIMED AT THE 1968 AUDIO FAIR

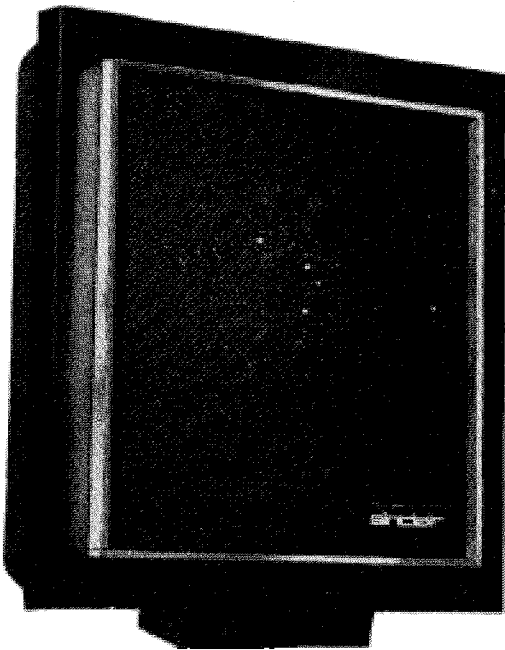

When the Sinclair Q.14 was demonstrated at this year's Audio Fair, it delighted some of the world's keenest and most critical listeners. It more than held its own against far more expensive loudspeakers and proved beyond all question that research and careful design could produce a loudspeaker for remarkably low price. The Q.14 measures 9 3/4 in. square on its face and finished in black matt with natural aluminium bar embelishment.

Its unique shape allows the Q.14 to be used in a far wider choice of positions than conventionally shaped speakers. A pair in stereo give true "in-depth" performance with complete freedom from listening fatigue. If you missed the Audio Fair, why not hear this speaker in your own home? Should it not please you, your money including cost of return post to this office will be refunded in full if purchased direct from Sinclair.

## ACCLAIMED BY USERS TOO

P.G. of Newry, N. Ireland writes: I have always been cynical about letters written to manufacturers praising their goods, but I am so delighted with the (two) Q.14 speakers that I feel I must write this for it sounds that you have given me a new collection of records. I congratulate you on a marvellous speaker at very reasonable cost.

●ACOUSTICALLY CONTOURED SOUND CHAMBER. ●LOADING UP TO 14 WATTS. ●BRILLIANT TRANSIENT RESPONSE ●REMARKABLY

SMOOTH RESPONSE FROM 60 to 16,000 Hz. ●15 OHMS IMPEDANCE. ●OF COMPACT AND ORIGINAL DESIGN. ●AN ALL-BRITISH PRODUCT.

# SINCLAIR Q.14

Post free and guaranteed

## £7.19.6



**SINCLAIR MICROMATIC** the world's smallest radio

## Indispensable

The ultimate in personal listening, the Sinclair Micromatic is as easy to have with you as your wrist-watch and you will quickly find it as indispensable. This set has enormous power and range, and the magnetic carpiece supplied with it assures quality. Hear how stations simply pour in on the M.W. band. Build it yourself or buy your Micromatic ready built. This is the set you will never be without once you hear it for yourself.

IN KIT FORM OR COMPLETE

Complete kit including magnetic ear-piece and instructions.

49/6

Ready built with magnetic ear-piece.

59/6

Mallory Mercury Cell RM.675 (2 needed) each 2/9.

The small versatile amplifier with the enormous output

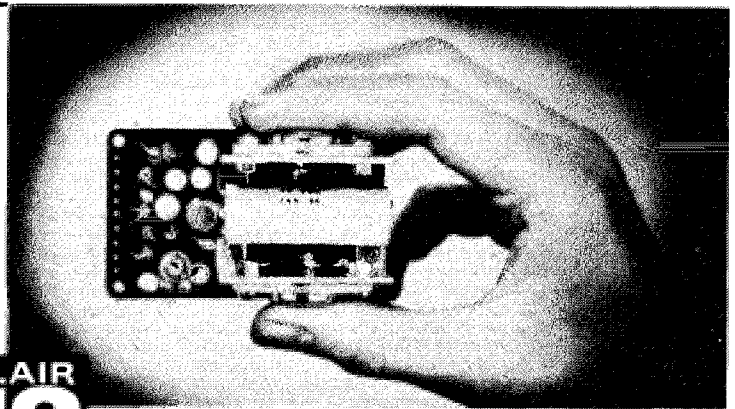

# SINCLAIR Z.12

## COMBINED 12 WATT HI-FI AMP & PRE-AMP

No constructor's transistor amplifier has ever achieved such success as the Sinclair Z.12. It favours the user in so many ways—with fantastic power-to-size ratio, with far greater adaptability, with freedom to operate it from batteries or mains power supply unit (the PZ.4 stabilised is ideal for this) with the opportunity to obtain superb stereo reproduction for very little outlay. Countless thousands of Z.12s are in use throughout the world—in hi-fi installations, laboratories and industry, electronic music instruments, P.A. installations, intercom systems, etc. This true 12 watt amplifier is supplied ready built, tested

and guaranteed together with the Z.12 manual which details control circuits enabling you to match the Z.12 to your precise requirements. 15 to 50,000 Hz  $\pm 1$ dB, using ultralinear Class B output. Input sensitivity -2 mV into 2k $\Omega$ . OUTPUT—12 WATTS R.M.S. CONTINUOUS SINE WAVE (24 w. PEAK), 15 WATTS MUSIC POWER (15 w. PEAK). Suitable for 3-15 $\Omega$  loudspeakers. Two 3 $\Omega$  speakers may be used in parallel.

For complete listening satisfaction, use your Z.12 system with Q.14 loudspeakers.

**BUILT, TESTED AND GUARANTEED 89/6**

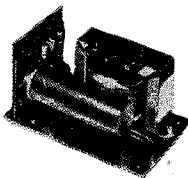

**SINCLAIR PZ.4 STABILISED POWER SUPPLY UNIT**

A heavy duty A.C. mains power supply unit delivering 18 v. D.C. at 1.5A. Designed specially for Z.12 assemblies. Ready built and tested.

99/6

**SINCLAIR STEREO 25**  
Control/Pre-amp for Z.12 stereo system  
Sensitivity Mic. 2mV into 50k $\Omega$ : P.U. -3 mV into 50k $\Omega$ : Radio -20 mV into 4.7k $\Omega$ . Equalisation correct to within  $\pm 1$  dB on RIAA curve from 50 to 20,000 c/s with brushed and polished aluminium front panel with knobs to match.  
**BUILT, TESTED AND GUARANTEED, £9/19/6.**

**GUARANTEE**  
Should you not be completely satisfied with your purchase when you receive it from us, your money will be refunded in full at once and without question. **FULL SERVICE FACILITIES AVAILABLE TO ALL PURCHASERS.**

**SINCLAIR RADIONICS LIMITED**  
22 NEWMARKET ROAD, CAMBRIDGE  
Tel.: OCA3 52996



To: SINCLAIR RADIONICS LTD., 22 NEWMARKET ROAD, CAMBRIDGE.

Please send POST FREE

NAME .....  
ADDRESS .....

For which I enclose cash/cheque/money order.

W.W.668

WW-107 FOR FURTHER DETAILS

# WHITELEY

## for acoustic hoods

All noisy environments such as factories, workshops, department stores and hotels require the facility of an acoustic hood which permits telephone conversations to be held without the interference of annoying background noises. Whiteley acoustic hoods are strongly made from resin bonded ply and finished in a cellulose enamel which makes these suitable for indoor or outdoor use.

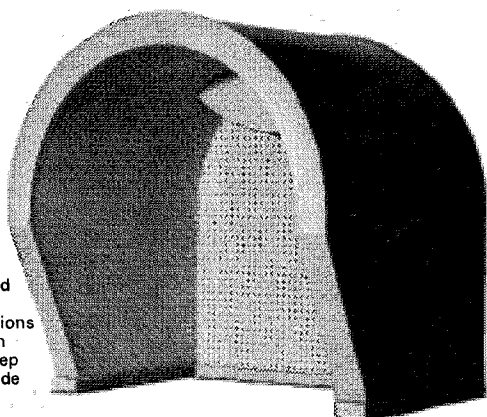

Standard Hood  
Dimensions  
25" high  
20½" deep  
24½" wide

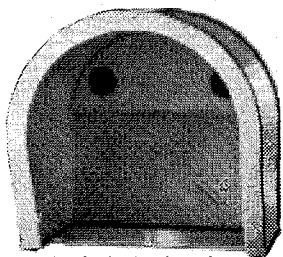

Fitted with loudspeakers

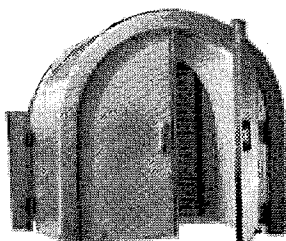

Fitted with doors for outdoor use

Also available with internal light and/or a storage shelf below hood

## & directory holders

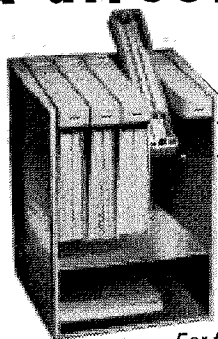

These attractive, and extremely functional directory holders will hold five directories neatly and securely, in individual swivel holders permitting easy identification and reference. The lower shelf provides additional storage space. The units are of cast alloy and are finished in an attractive grey epoxy resin enamel and constructed to strict G.P.O. design specifications.

Directory Holder Dimensions  
17½" high x 13½" wide x 13½" deep

For further details please write or telephone

**WHITELEY ELECTRICAL RADIO CO. LTD**

MANSFIELD · NOTTS · ENGLAND Tel: Mansfield 24762  
London Office: 109 KINGSWAY, W.C.2 Tel: HOLborn 3074

WW-108 FOR FURTHER DETAILS

**ILIFFE  
BOOKS**

## ELEMENTS AND CIRCUITS FOR AUTOMATIC CONTROL

By T. PUCHALKA and A. WOZNIAK.

English translation edited by N. G. Meadows, Ph.D., B.Sc.,  
C. Eng., M.I.E.E.

This book gives examples of typical elements of control systems and discusses their applications in systems for automatic control.

It opens with a chapter dealing with fundamentals of control theory, which is of interest in its own right and also gives a fundamental basis for subsequent work. This is followed by an extended treatment of the dynamic behaviour of electrical circuits and electrical machines as elements in control loops, together with various aspects of non-linear behaviour. The third chapter is devoted to a discussion of selected elements of electrical control systems, classified on the basis of single-loop block diagrams. Finally, the book deals with stability criteria, stability synthesis and the general dynamical analysis of selected systems.

221 pp. 146 illus. 50s net. 1s 6d postage.

obtainable from leading booksellers

**ILIFFE BOOKS LTD.**  
42 RUSSELL SQUARE, LONDON, W.C.1

## IGNITRONS FOR RESISTANCE WELDING

Immediate delivery of the following types:

- 5551 (without thermostat platform) £14
- 5551A (with thermostat platform) £15
- 5552 (without thermostat platform) £19
- 5552A (with thermostat platform) £21

Write, Phone, Cable or Telex:

**Z & I AERO SERVICES LTD.,**  
44A, WESTBOURNE GROVE, LONDON, W.2

Tel: PARK 5641/2/3 Cables: ZAERO LONDON  
Telex 261306

WW-109 FOR FURTHER DETAILS

## LONDON microphones

Quality sound—at low cost

The London Microphone range offers you quality microphones, good characteristics—and good looks, too, at remarkably little cost. Made in Britain.

**LM 100 Dynamic Omni-directional microphone.**  
available in a range of impedances to suit many different input requirements including transistorised tape recorders. U.K. retail price range £3/3/0-£3/18/6

**LM 200 Dynamic cardioid microphone. Balanced output.**  
Eliminates unwanted background noise. Gives good recordings even under difficult conditions.

U.K. prices  
£4/19/6  
£5/15/0

Home and overseas trade enquiries welcome. Write or ring for details:

**LONDON MICROPHONE CO. LTD.**

182/4 Campden Hill Road, London, W.8 Tel: Park 0711. Telex 23894

WW-110 FOR FURTHER DETAILS



# LOW NOISE AMPLIFIER

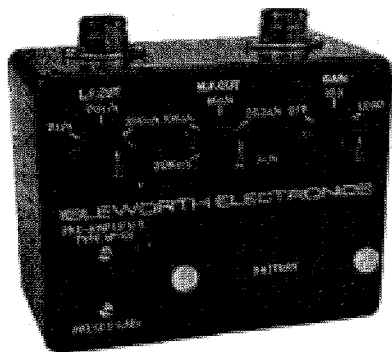

TYPE  
A101

Price  
£50

This unit is a solid state A.C. differential pre-amplifier, featuring a parametric input stage making it suitable for all types of work, for example, electrophysiology, involving high signal source impedances.

Power is either from an internal mercury battery, or a separate stabilised mains unit, P101, supplying up to ten amplifiers. The units may be used separately, or up to three mounted on a standard 19 inch rack panel, 5½ high.

Noise—less than 10 microvolts peak to peak input short circuit, bandwidth 2 c/s to 20 kc/s.

Input impedance—10 megohms minimum.

Common mode rejection—1 million to one (120db) at 50 c/s. Gain—switched, 100 or 1000.

Bandwidth 2 c/s to 20 kc/s. with L.F. cuts at 2 c/s., 20 c/s., 200 c/s. H.C. cuts at 20 kc/s., 5 kc/s., 1000 c/s., 200 c/s., 50 c/s.

## ISLEWORTH ELECTRONICS

FREDERICK STREET,  
WADESODON, BUCKS.  
Tel.: WADESODON 220

WW—120 FOR FURTHER DETAILS

## OLSON

Instrument cases and chassis

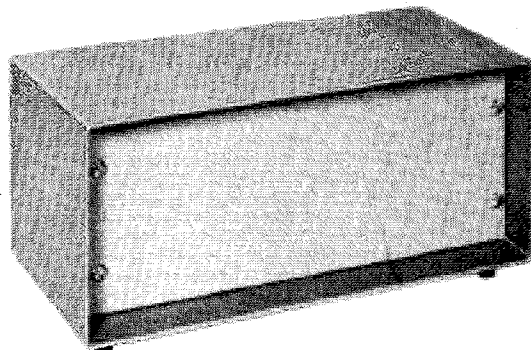

Ask for latest catalogues on our **NEW RANGES!**

OLSON ELECTRONICS LTD., 5-7 Long St., London, E.2. Tel 01-739 2343

WW—121 FOR FURTHER DETAILS

## OLSON

### DISTRIBUTION PANELS



Complete with fixing brackets and 4 plastic feet, 6ft. cable 13A. plug and spare fuse

4 SOCKETS	13A.	..	..	..	£4 . 19 . 6
6 SOCKETS	13A.	..	..	..	£5 . 17 . 6
4 SOCKETS	5A.	..	..	..	£5 . 10 . 0
6 SOCKETS	5A.	..	..	..	£6 . 15 . 0

PLUS POSTAGE AND PACKING 6/6

OLSON ELECTRONICS LTD., 5-7 LONG ST., LONDON, E.2.  
TEL: 01-739 2343

WW—122 FOR FURTHER DETAILS



# RADFORD

## AUDIO LABORATORY INSTRUMENTS

### LOW DISTORTION OSCILLATOR (Series 2)

An instrument of high stability providing very pure sine waves, and square waves, in the range of 5 Hz to 500 kHz. Hybrid design using valves and semiconductors.

#### Specification

Frequency Coverage: 5 Hz-500 kHz (5 ranges).  
Output Impedance: 600 Ohms.  
Output Voltage: 10 Volts r.m.s. max.  
Output Attenuation: 0-110 dB continuously variable.  
Sine Wave Distortion: 0.005% from 200 Hz to 20 kHz increasing to 0.015% at 10 Hz and 100 kHz.  
Square Wave Rise Time: Less than 0.1 microseconds.  
Monitor Output Meter: Scaled 0-3, 0-10, and dBm.  
Mains Input: 100 V.-250 V. 50/60 Hz.  
Size: 17½ × 11 × 8in.  
Weight: 25 lb.  
Price: £150.  
Rack mounting version available.

### DISTORTION MEASURING SET (Series 2)

A sensitive instrument for the measurement of total harmonic distortion, designed for speedy and accurate use. Capable of measuring distortion products as low as 0.002%. Direct reading from calibrated meter scale.

#### Specification

Frequency Range: 20 Hz-20 kHz (6 ranges).  
Distortion Range: 0.01%-100% f.s.d. (9 ranges).  
Sensitivity: 100 mV.-100 V. (3 ranges).  
Meter: Square law r.m.s. reading.  
Input Resistance: 100 kOhms.  
High Pass Filter: 3 dB down to 350 Hz. 3 dB down to 35 Hz.  
Frequency Response: ±1 dB from second harmonic of rejection frequency to 250 kHz  
Power Requirements: Included battery.  
Size: 17½ × 11 × 8in.  
Weight: 15 lb.  
Price: £120.  
Rack mounting version available.

### VOLTMETER (new item)

A transistor operated voltmeter satisfying the requirements for audio frequency measurement.

#### Specification

Sensitivity: 1 mV.-300 V. f.s.d. (12 ranges).  
Calibration Accuracy: 2% f.s.d.  
Frequency Response: ±1 dB. 10 Hz-500 kHz.  
Input Impedance: 1 MOhm. 1 mV.-300 mV. 10 MOhm. 1 V.-300 V.  
Meter Scaled: 0-3, 0-10, and dBm.  
Power Requirements: Included battery.  
Size: 11½ × 6½ × 6in.  
Weight: 7 lb.  
Price: £35.

## RADFORD LABORATORY INSTRUMENTS LTD

Ashton Vale Road  
Bristol 3

WW—123 FOR FURTHER DETAILS







A new science project combining the fascination of optics with electronics . . . the new field of

**SUB LASER!**

# OPTOELECTRONICS

## from PROOPS

Demonstrations of these devices operating as

**SPEECH LINK**  
and  
**ON/OFF LINK**

are being given daily at our only address,

52 TOTTENHAM COURT ROAD,  
LONDON, W.1.

These new devices offer features which can be exploited in an extremely wide field of applications. Their outstanding modulation and switching capabilities, coupled with completely solid state circuit design and small physical size make them ideally suited to such purposes as short distance speech and data links, remote relay controls, safety devices, burglar alarms, batch counters, level detectors, etc.

### MGA100

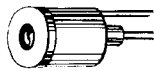

**28' 6** Post Free  
EACH

**TYPE MGA 100 General Purpose Gallium Arsenide Light Source**  
A filamentless, Gallium Arsenide infra-red emitter, only 5.54 mm. dia. and 8.1 mm. long. Features a robust cylindrical package coaxial with the beam, facilitating optical alignment and heat-sinking.

**MAX RATINGS**

Forward current  $I_F$  max.\* D.C. . . . . 400mA. Forward peak current  $I_F$  max.\* (pk) . . . . . 6A  
Power dissipation\* . . . . . 600mW. Derating factor for  $T_{amb}$  greater than 25°C. . . . . 7.5mW/°C.  
Reverse voltage  $V_R$  max. . . . . 1-0V.

\*When mounted on an aluminium heat sink 1in. x 1/2in. x 1/2in.  
Supplied complete with suitable lenses, full Technical Data and Application Sheets, including Line of Sight Speech Link.

**TYPE MSP3 Solid State Photo Receiving Device**

An ultra-sensitive infra-red and visible light detector, this device is a complete silicon photo-electric receiver with a peak spectral response at 9500Å. Size only 6.4 mm. dia. and 25.4 mm. long, yet absolutely complete, the device will generate sufficient power to drive an external relay. Chiefly intended for use in optical links based on Gallium Arsenide Light Sources, they are equally suitable for systems based on visible light. Features a robust cylindrical package coaxial with the incident light facilitating optical alignment and heat-sinking.



### MSP3

**85' -** EACH  
Post Free

**MAX RATINGS**

Total dissipation (in free air,  $T_{amb}=25^\circ\text{C}$ ) . . . . . 100mW. Derating Factor . . . . . 2mW/°C.  
Output Current Intensity . . . . . 100mA. Voltage . . . . . 25V. Operating Temperature . . . . . from -30° to +125°C.

Supplied complete with suitable lenses, full Technical Data and Application Sheets, including Line of Sight Speech Link.

### 31F2

**28' 6** EACH  
Post Free

**Type 31F2 Micro-miniature Infra-Red Detector**

Extremely small photo diodes of silicon NPN passivated planar construction and suitable for Punched Card Readers, Counters, Film Sound Track, etc.

Supplied complete with suitable lenses, full Technical Data and Application Sheets, including Line of Sight Speech Link.

### ... and these new solid state devices ...

**RCA TRIACS Type 40432**

Intended primarily for phase control of A.C. loads in light dimming, universal and induction motor control, heater control, etc., these gate controlled full-wave A.C. silicon switches, with integral trigger, switch from a blocking state to a conducting state for either polarity of applied voltage with positive or negative gate triggering.

Supplied complete with full Data and Application Sheets.



**45' -** EACH  
Post Free

**INTEGRATED CIRCUIT RCA-CA 3020 AF POWER AMPLIFIER & PRE-AMPLIFIER (or servo-amplifier).**

The RCA-CA 3020 is an integrated-circuit, Multistage, Multi-Purpose AF Power Amplifier on a single monolithic silicon chip, providing a stabilized direct-coupled amplifier, performing pre-amp., phase inverter, driver and power output functions without transformers, and with one power supply suitable for sound, communications and control systems.

Supplied complete with full Data and Application Sheets.



**42' -** EACH  
Post Free

## PROOPS BROTHERS LIMITED

52 Tottenham Court Road, London, W.1.  
Telephone: LAngham 0141. (01-580 0141)



**IMMEDIATE DESPATCH** FULL SPARES AND SERVICE AVAILABLE

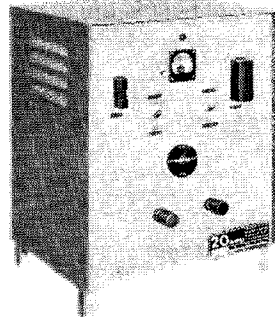

**20 Amp. LT. SUPPLY UNIT**

As supplied to Min. of Defence and Crown Agents for overseas Govt.  
**LATEST DESIGN HEAVY DUTY 12/24 VOLT D.C.**

Output: Adjustable up to **20 AMPS. CONTINUOUS** at 12/24 volts.  
**FULLY FUSED**, Neon indicator, 0-20 amp. meter. Size 16 x 12 x 20in high, in heavy gauge steel cabinet. Grey Hammer finish—Weight 50 lb.  
Input: 220/230/240 v. A.C. 50 cycles.  
**ONLY £32.10.0** Plus 40/- C. & P. G.B. (Inland)

**30 Amp. LT. SUPPLY UNIT**

UP TO 18 v. D.C. WITH SMOOTH STEPLESS VARIATION  
Designed for CONTINUOUS use at max. loading

★ Fitted voltmeter and ammeter. ★ Instantaneous overload cut-out.  
Input: Mains A.C. Robust construction, 2 tone finish, steel case.

**£55.0.0**

C. & P. 40/- G.B. (Inland).  
Entirely suitable for plating plants, Laboratory supplies, etc.

**5 AMP. A.C. & D.C. VARIABLE SUPPLY UNIT**

Specification } Input: 240 VAC  
                  } Output: 0-260 v. A.C. 0-240 v. D.C.

- ★ Smooth stepless voltage variation from 0-Max.
- ★ Current consistent throughout the controlled range.
- ★ Ammeter and voltmeter fitted, and neon indicator.
- ★ Fully fused input and output.

Strong steel case, with carrying handle and rubber feet.  
11 x 7 x 14in. high. Made in England.

**£30.0.0**

C. & P. 40/-, Gt. Britain (Inland).

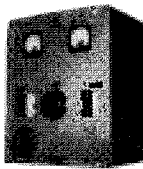

**CURRENT PRODUCTION — BUY DIRECT FROM MANUFACTURER**

**VARIABLE VOLTAGE TRANSFORMERS**

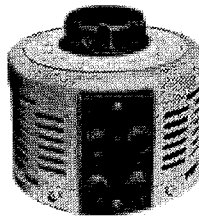

Modern styling for modern equipment

'SLIDE-TRANS' & 'SLIDUP' MODELS

Fully rated current consistent at all points along the winding

**AVAILABLE ONLY FROM I.M.O.**

- ★ SMOOTH CONTINUOUS ADJUSTMENT
- ★ ALL MODELS SHROUDED FOR SAFETY (IDEAL FOR EDUCATIONAL AUTHORITIES)
- ★ BENCH OR PANEL MOUNTING
- ★ UP TO 260v. AVAILABLE FROM ALL MODELS

All models 230v. A.C. 50/60 c.p.s. input

1 Amp.	£5.15.0
2.5 Amp.	£6.17.6
5 Amp.	£9.19.0
8 Amp.	£14.15.0
10 Amp.	£18.10.0
12 Amp.	£21.10.0
20 Amp.	£38.10.0

C. & P. EXTRA

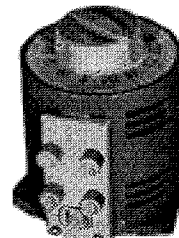

**TRANSISTORISED MEGOHMETER**

- ★ **PUSH BUTTON TO READ**



500 v. - 1,000 Megohms. Superb portable instrument. Supplied c/w batteries, probes and carrying case.

**ONLY £25.0.0** C. & P. 7/6

**36 FT. AERIAL MAST**

**NEW LATEST PATTERN TUBULAR MAST**

Check these vital points:

- ★ Made from 6 x 1 1/2in. Sheradized steel sections, for durability and strength.
- ★ Extra strong locating base.
- ★ Top cap with fitted pulley and halyard.
- ★ 2 sets (8) Retproof Guys.
- ★ Rustproofed Steel Picketing Stakes.



**ONLY £15.0.0** ex works  
Carr. 20/- Returnable wood case 40/-

**VARIABLE HIGH VOLTAGE SAMPLING TESTER**

**DIELECTRIC BREAKDOWN TESTER**

- ★ Range: Infinitely variable up to 3,000 volts 0.1 amp.
- ★ Entirely suitable for continuous testing.
- ★ Automatic safety cut-out. Input: Mains voltage. Input and test leads with clips. Model T30 C. & P. 25/-

**£15**

**COMPLETE PHOTO-ELECTRIC SENSOR in one unit**

- ★ REFLECTIVE TYPE WITH BUILT-IN LIGHT SOURCE
- ★ WILL ALSO OPERATE FROM REMOTE LIGHT SOURCE
- ★ MATCHBOX SIZE
- ★ SENSES ANY OBJECT—COLOURS, THICK SMOKE

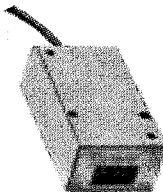

Operates from 12 V. A.C. Output signal 0.2 amp. 100 V.

Approximately **£5.10.0** dependent on quantity.

**CONSTANT VOLTAGE TRANSFORMERS AUTOMATIC MAINS STABILISER**

- ★ No attention
- ★ No Maintenance
- ★ No Moving Parts
- ★ Corrected Wave

Input: 195-250v. A.C. Output: 240v. A.C. Accuracy: ±1%. Capacity: 250 watts. Maintain "spot-on" test-gear readings at all times. Weight: 21 lb. Fitted signal lamp and switch. Size: 11 x 6 1/2 x 6in. high.

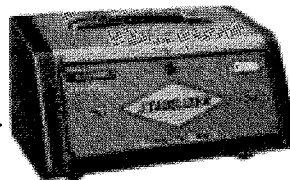

**£12.10.0** C. & P. 20/-

**LATEST SOLID STATE VARIABLE VOLTAGE CONTROL**

- ★ COMPLETELY SEALED
- ★ COMPACT
- ★ PANEL MOUNTING



230 V.A.C. Input 25-230 volts output.

5amp. model £8/7/6 P. P. Extra  
10 amp. model £13/15/-

**PORTABLE VARIABLE A.C. POWER SUPPLY UNIT**

Designed for engineers whose requirements call for a visual indication of volts applied.

OUTPUT: 0-260 v. 1 1/2 amps.  
INPUT: 230 v. A.C. 50/60 c.p.s. Fitted with fuse, voltmeter, safety indicator on-off switch and lead. Size 8 x 5 x 5in. high.

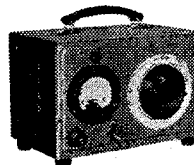

PRICE **£9.2.6.** C. & P. 12/6

**PORTABLE TRANSISTOR TESTER SUITABLE FOR PRODUCTION & LABORATORY USE**

SPECIFICATION:

Alpha 0.7 to 0.997  
Beta 5-300  
ICO 0-50µA. 5mA.

Capable of measuring GERMANIUM AND SILICON DIODES.

DESIGNED WITH RESISTANCE SCALE 200 ohms to 1 Megohm as an ADDED FEATURE. Housed in heavy duty plastic case, c/w internal battery.

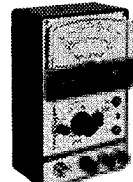

Only **£6.19.6**  
Plus 7/6 C. & P.

**I.M.O. (ELECTRONICS) LTD.**

(Dept. W.W.7), 313 Edgware Road, London, W.2.

01-723 2233/4











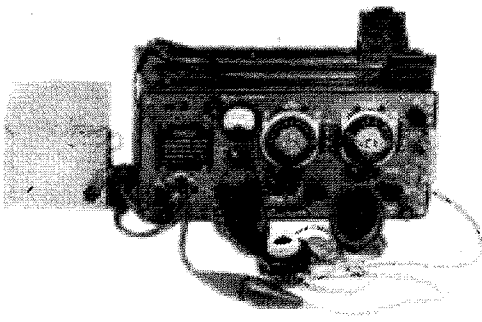

## TRANS/RECEIVER TWO-TWO

This is one of the Latest Releases by the Govt. of an extremely recent R/T set covering 2-8 Mc/s in two switched Bands, containing 13 Valves (3 EL32s in TX Output) which can be used for Morse CW or R/T. Also has Netting Trimmer, BFO, RF & EF Controls, Switched Meter for checking all parts of set, Size 17in. x 8in. x 12in. Power required LT 12 volts DC, HT 325 Volts D.C. **Supplied Brand New and Boxed with Headphones & Mike, also Two Spare Valves and Circuit of set. Few only at £5/10/-, Carr. 30/-.** New Plug in Power Supply made by us for either 12 volts D.C. Input £5/10/- or 200/250 Volts A.C. £3/17/6.

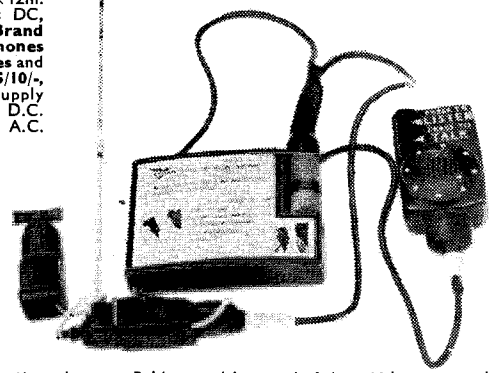

## LARGE QUANTITY OF SARAH V.H.F. TRANS/RECEIVERS AVAILABLE FOR IMMEDIATE EXPORT.

General information. This set is normally carried in the life jacket of Airmen, it is a complete miniature lightweight radio Trans/Receiver, which is used to give a Beacon plus two way speech communication in the event of finding themselves in the sea. It comprises a Transmitter-Receiver, a speech unit, a coding unit and a power supply either Battery OR Transistor. These three items are permanently inter-connected and all units are completely sealed and watertight using a combined speaker/Mike, Press to talk or listen buttons, Fold up aerial, a total of three Valves are used, power required 6.3 Volts LT 90 Volts and 435 Volts DC RT. Frequency 243 Mc/s. Transmitter output pulse power—Beacon 15 Watts, Talk 3 Watts. **Supplied in maker's boxes in Grade I condition singly at 45/-, post 5/- with circuit. New batteries if available 7/6 each.**

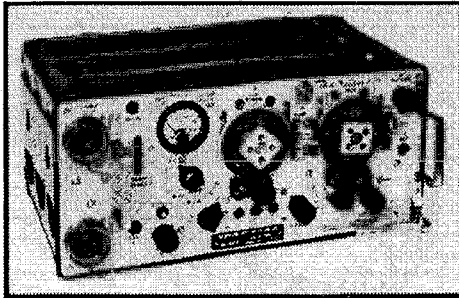

FAMOUS ARMY SHORT-WAVE TRANSRECEIVER MK. III

This set is made up of 3 separate units: (1) a two valve amplifier using a 6V6 output valve; (2) (some only, not built in the very latest models) a V.H.F. transceiver covering 228-241 Mc/s using 4 valves; (3) the malshort wave transmitter/receiver covering in two switched bands, just below 2 Mc/s-4 1/2 Mc/s, and 4 1/2 Mc/s-8 Mc/s (approx. 160-37.5 metres) using 9 valves. For R.T., C.W. and M.C.W. The receiver is superhetrodyne having 1 R.F. stage, frequency changer, two I.F. (465 Kc/s) signal detector, A.V.C. and output stage. A B.F.O. included for C.W. or single side-band reception. T.X. output valve 807, other valves octal bases. Many extras, e.g. netting switch, quick flick dial settings, squelch, etc. Power requirements LT 12 volts, HT receiver 275 volts D.C. HT transmitter 500 volts D.C., size approx. 17 1/2 x 7 1/2 x 11ins. Every set supplied in new or as new condition in carton with book including circuits, only £4/10/- or Grade 2 slightly used 50/- or Grade 3 used but complete, 35/-, Carr. ALL 15/- WE MAKE A MAINS 200/250 VOLT POWER UNIT in louvered metal case to plug direct into set power socket to run (1) receiver, 70/- post 5/-, (2) TX and RX, £6/10/-, post 7/6, (3) 12 volt D.C. P.T. (original) fair condition, 40/-, Carr. 3/-, A charge of 10/- to unpack and test the receiver of these sets is made only if requested. Headphones & Mike, 15/-, new and boxed.

This is a modern self contained tunable V.H.F. low powered frequency modulated transceiver for R.T. communication up to 8-10 miles. Made for the Ministry of Supply at an extremely high cost by well-known British makers, using 15 midget B.G. 7 valves, receiver incorporating R.F. amplifier. Double superhet and A.F.C. Slow motion tuning with the dial calibrated in 41 channels each 200 kc/s apart. The frequency covered is 39 mc/s-48 mc/s. Also has built-in Crystal calibrator which gives pips to coincide with marks on the tuning dial. Power required L.T. 4 1/2 volts, H.T. 150 volts, tapped at 90 volts for receiver. Every set supplied complete with valves and crystals. New in carton, complete with adjustable whip aerial, and circuit. **Price £4 10s 0d, carriage 10s.**

V.H.F. TRANSRECEIVER MK. I/I

JOHN'S RADIO OLD CO-OP, WHITEHALL ROAD, DRIFHLINGTON, BRADFORD. Tel.: DRIFHLINGTON 2732

## BUILD YOURSELF A QUALITY TRANSISTOR RADIO!



**TRANSONA FIVE MED. LONG & TRAWLER BAND.** 5 transistors and 2 diodes, ferrite rod aerial, tuning condenser, volume control, 2 1/2in. speaker, 6 1/2 x 4 1/2 x 1 1/2in. **Total Building Costs 42/6.** P. & P. 4/6. Plans and Parts list 1/6 (free with parts).

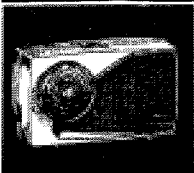

**MELODY MAKER SIX.** Med. & Long Waves & Extended Med. Wave Band. 6 transistors and 2 diodes. Push-pull output, tuning condenser, high "Q" ferrite rod aerial, 3in. speaker, etc. 6 1/2 x 3 1/2 x 1 1/2in. **Total Building Costs 69/6.** P. & P. 4/6. Plans and parts list 2/- (free with parts).

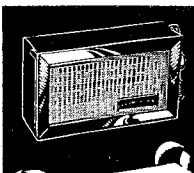

**POCKET FIVE. MED. & LONG WAVES & EXTENDED MED. WAVE BAND.** 5 transistors and 2 diodes, ferrite rod aerial, tuning condenser, 2 1/2in. speaker, etc. 5 1/2 x 1 1/2 x 3 1/2in. **Total Building Costs 39/6.** P. & P. 4/6. Plans and Parts list 1/6 (free with parts).



**SUPER SEVEN. MED. LONG & TRAWLER BAND.** 7 transistors and 2 diodes, 3in. speaker, 2 R.F. stages, push-pull output, etc. 7 1/2 x 5 1/2 x 1 1/2in. **Total Building Costs 69/6.** P. & P. 4/6. Plans and parts list 2/- (free with parts).

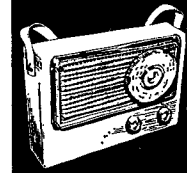

**ROAMER SEVEN Mk. 4, 7 wavebands—MW1, MW2, LW, SW1, SW2, SW3 and Trawler Band.** 7 transistors and 2 diodes. Ferrite rod aerial and telescopic aerial. Socket for car aerial, 7 x 4in. speaker. Airstreamed ganged tuning condenser, etc. Size 9 x 7 x 4in. **Total Building Costs 25/19/6.** P. & P. 7/6. Plans and parts list 3/- (Free with parts).

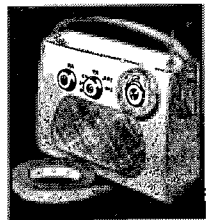

**ROAMER SIX.** 6 wavebands—MW1, MW2, SW1, SW2, LW and Trawler Band. 6 transistors and 2 diodes. Ferrite rod and telescopic aerials. 3in. speaker. Tip grade component. Size 7 1/2 x 3 1/2 x 1 1/2in. **Total Building Costs 79/6.** P. & P. 4/6. Plans and parts list 2/- (free with parts).

RADIO EXCHANGE CO. LTD., 61 High Street, Bedford. 'Phone: 52367

Callers side entrance Stylo Shoe Shop Open 9—5 p.m. (Sat. 9—12.30 p.m.)

### 4-STATION INTERCOM

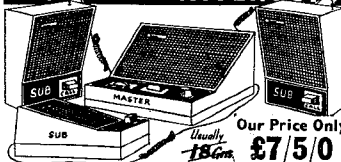

Our Price Only **£7 5/0** Usually 18 Gns.

Solve your communication problems with this new 4-Station Transistor Intercom system (1 master and 3 subs), in de luxe plastic cabinets for desk or wall mounting. Call/talk/listen from Master to Subs and Subs to Master. Operates on one 9 v. battery. On/off switch. Volume control. Ideally suitable to modernise Office, Factory, Workshop, Warehouse, Hospital, Shop, etc., for instant inter-departmental contacts. Complete with 3 connecting wires, each 66ft. and other accessories. Nothing else to buy. P. & P. 7/6 in U.K.

### INTERCOM/BABY ALARM

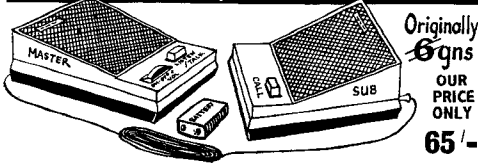

Originally 8 Gns  
OUR PRICE ONLY **65/-**

Same as 4-Station Intercom for two-way instant conversation. Ideal as Baby Alarm and Door Phone. Complete with 66ft. connecting wire. Battery 2/6. P. & P. 3/6.

### 7-STATION INTERCOM

(1 MASTER & 6 SUB-STATIONS) in strong metal cabinets. Fully transistorised. 3 1/2in. Speakers. Call on Master identified by tone and Pilot lamp. Ideally suitable for Office, Hotel, Hospital and Factory. Price 27 gns. P. & P. 12/6 in U.K.

WW115—FOR FURTHER DETAILS

### Transistor TELEPHONE AMPLIFIER



Usually 8 Gns  
OUR PRICE ONLY

**59/6**

Why not increase efficiency of Office, Shop and Warehouse with this incredible De-Luxe Portable Transistor TELEPHONE AMPLIFIER which enables you to take down long telephone messages or converse without holding the handset. A useful office aid. A must for every telephone user. Useful for hard of hearing persons. On/off switch. Volume Control. Operates on one 9 v. battery which lasts for months. Ready to operate. P. & P. 2/6 in U.K. Add 2/6 for Battery. Full price refunded if returned in 7 days.

WEST LONDON DIRECT SUPPLIES (W.W.). 169 Kensington High Street, London, W.8



# Lasky's Radio

## TAPE RECORDERS

**NOTE** WE HAVE EXTENSIVE STOCKS OF ALMOST EVERY TYPE OF RECORDER AT PRE-BUDGET PRICES SEND DETAILS OF YOUR REQUIREMENTS NOW!

## RECORD PLAYERS

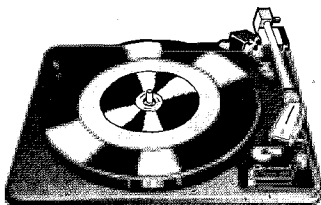

### GARRARD AUTOCHANGERS

AP75 .....	£22/11/6
AT80 Mk. II .....	£18/19/6
3000LM with stereo cart. ....	£9/19/6
470 .....	£13/19/6
Lab. A Mono/Stereo .....	£14/19/6
Lab. A. on plinth .....	£15/19/6
A50 .....	£7/7/0
A1000 .....	£7/7/0
A2000 .....	£7/17/6

### TRANSCRIPTION MOTORS

GARRARD 401 .....	£27/19/0
GARRARD Lab. 80 Mk. II .....	£25/0/0

### GARRARD BASES

WB1 .....	£3/16/3	WB2 ..	£5/5/0
-----------	---------	--------	--------

### CLEARVIEW PERSPECT COVERS

WB1 .....	£3/17/0	WB2 ..	£5/7/11
-----------	---------	--------	---------

Postage on all above 5/- extra.

### SINGLE PLAYERS

Auto start and stop. Complete with pick-up arm\*

GARRARD SP25 Mk. I .....	£10/19/6
GARRARD SP25 Mk. II Heavy/turntable .....	£11/19/6
GARRARD SRP12 .....	£4/7/6
GARRARD SRP10 mains model .....	£4/19/6
GARRARD SRP10 batt. model .....	£4/19/6

## CONSTRUCTORS BARGAINS

### THE SKYROVER DE LUXE

7 transistor plus 2 diode superhet, 6 waveband portable receiver covering the full Medium Waveband and Short Waveband 31-94M and also 4 separate switched band spread ranges, 13M, 16M, 19M, and 25M, with Band Spread Tuning for accurate Station Selection. The coil pack and tuning heart is factory assembled, wired and tested. Superhet 470 Kc/s. Mullard Transistors. Uses 4 U2 batteries. 5in. Ceramic Magnet P.M. Speaker, 500 MW Output. Telescopic Aerial and Ferrite Rod Aerial. Tone Circuit in wood cabinet, size 11½ x 6½ x 3in. covered with washable material, plastic trim and handle. Car aerial socket fitted.

Can now be built for **£8.19.6** Post 5/- extra.  
H.P. Terms: 60/- dep., 11 mths. at 12/9. Total H.P. £10/0/3.

Data 2/6. Refunded if you purchase parcel. Four U2 batts. 3/4 extra. All components avail. separately. A simple additional circuit provides coverage of the 1100/1900M. Long Waveband. All necessary components with construction data. Only 10/- extra. Post Free. This conversion is suitable for receivers already constructed.

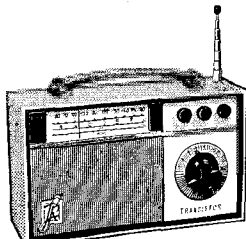

Data 2/6. Refunded if you purchase parcel. Four U2 batts. 3/4 extra. All components avail. separately. A simple additional circuit provides coverage of the 1100/1900M. Long Waveband. All necessary components with construction data. Only 10/- extra. Post Free. This conversion is suitable for receivers already constructed.

## LASKY'S PRECISION PANEL METERS

Precision made in Japan by HIOKI. Each meter boxed and fully guaranteed with all fixing nuts and washers. Sizes are of front panel. Add 1/6 P. on each. Special quotation for quantities.

Type MK-38A	Type KR-52	Type KR-52	Type MK-45A	Type MK 65A
1½in. sq.	3 x 2½in.	3½ x 3in.	2in. sq.	3in. sq.
1mA DC .. 29/6	1mA DC .. 47/6	5mA DC .. 36/-	1mA DC .. 25/-	1mA DC .. 38/-
5mA DC .. 22/6	5mA DC .. 32/6	50V DC .. 35/-	5mA DC .. 28/-	5mA DC .. 35/-
300V DC .. 22/6	300V DC .. 32/6	50µA .. 58/-	300V DC .. 25/-	300V DC .. 35/-
50µA .. 36/-	100µA .. 47/6	100µA .. 49/6	500µA .. 25/-	500µA .. 39/6
500µA .. 27/6	1mA S mtr 37/6	1mA S mtr 39/6	1mA S mtr 35/-	1mA S mtr 37/6

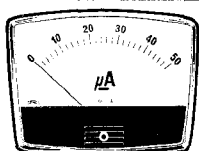

## TRANSISTOR FM TUNER CHASSIS

Fully tunable—range 88 to 108 Mc/s. Completely wired on printed circuit. 10.3 Mc/s. 1F 6 transistors and 3 diodes. Slow motion tuning drive. Size 6½ x 4 x 2½in. Operates from any 9 v. D.C. source. Full data and circuit.

**LASKY'S PRICE £6.10.0** Post 5/- extra.

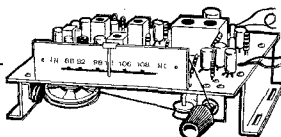

## MULTIPLEX ADAPTOR

Now you can enjoy stereo sound with the FM Tuner above. Brief spec.; MPX input sensitivity 100mV Output 180mV. Self powered by a 9v. battery. 4 transistor and 6 diode circuit. Size 5½in. x 2in. x 2½in. Also suitable for use with other FM tuners with MPX input.

**LASKY'S PRICE 99/6** Post 5/6.

**PACKAGE PRICE IF BOUGHT TOGETHER £11/11/-.** Post 5/-.

## DON'T MISS THIS!

**HAVE YOU GOT YOUR LASKY'S CATALOGUE FREE** Second Great Reprint Issue Now Ready Containing over 1,500 items from our vast stocks. Just send your name, address and 1/- for post only.

### Branches

<b>207 EDGWARE ROAD, LONDON, W.2</b>	Tel.: 01-723 3271
Open all day Saturday, early closing 1 p.m. Thursday	
<b>33 TOTTENHAM CT. RD., LONDON, W.1</b>	Tel.: 01-636 2605
Open all day, 9 a.m.—6 p.m. Monday to Saturday	
<b>152/3 FLEET STREET, LONDON, E.C.4</b>	Tel.: FLEet St 2833
Open all day Thursday, early closing 1 p.m. Saturday	

**ALL MAIL ORDERS AND CORRESPONDENCE TO: 3-15 CAVELL ST., TOWER HAMLETS, LONDON, E.1 Tel.: 01-790 4821**

WW—116 FOR FURTHER DETAILS

## COMPLETE SYSTEMS

## SPECIAL HI-FI ECONOMY PACKAGE

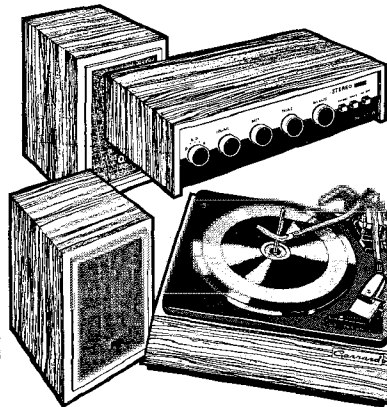

At a time when value for money must rank especially high in importance we are introducing Package Deal complete Hi-Fi systems. These are carefully matched for compatibility, sacrificing nothing in quality with the great advantage of the considerable cash savings that our Package Deal planning allows over a wide price range.

Philips GH925 stereo amplifier .....	£24 3 0
Garrard AT80 Mk. II, 4 speed autochanger .....	£16 7 7
Acos GP98 stereo ceramic cart-ridge .....	£2 12 11
Garrard WB.1 teak plinth .....	£3 16 0
2 Foster FCS 104 bookshelf loudspeaker systems .....	£19 19 0
<b>TOTAL LIST PRICE</b>	<b>£66 18 6</b>

**Lasky's Package Price £61.0.0.** U.K. Carriage 50/-  
Package Price with 2 Philips GL 559 loudspeaker systems £64.0.0

## AMPLIFIERS

## TRIO TK-150E STEREO AMP.

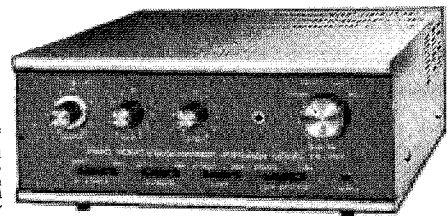

Trio equipment is renowned the world over for quality—now this famous company break the price barrier with an absolutely new budget priced Hi-Fi unit. The TK-150E is an extremely compact 19 transistor and 8 diode stereo amplifier giving 40 watts music power, 13 W RMS power per channel. Inputs are provided for Magnetic pick-up (2.1mV), Tuner (130mV), and 2 Auxiliary Inputs (130mV. each) for use with another Tuner or Tape Recorder, sep. input for tape recorder (130mV). Built-in tape monitoring circuit. Outputs for speakers, stereo headphones, tape play, 60W A.C. power outlet also provided. Controls include: Volume (L & R), bass, treble, input selector, power on/off, loudness, mode (stereo/mono), tape monitor/play (the last four are rocker switches). Frequency response 20-50,000 Hz (+1 dB). Signal to noise ratio: Mag. P.U.—better than 65dB, Tuner/Aux.1 and 2—better than 70dB, tape play—better than 75dB. RIAA equalisation. Built-in power transistor protection circuit. Power requirements 200/250V. A.C. 50/60c/s. The superbly made and styled cabinet measures only 10½ x 9½ x 4½in. Dark matt finish control panel with silver anodised trim and black/silver controls. Complete with detailed instruction manual and circuit data.

**Lasky's Price 32 Gns.** Carriage FREE in U.K.

## MODEL KT-55 TRANSISTORISED STEREO AMP.

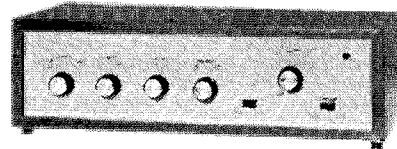

Made by well-known British manufacturer and incorporating the very latest transistor circuitry. Spec.: Output 5 watts per channel, 14 transistors (7 per channel) plus rectifier and varactor in each channel; frequency response 25 c/s to 35 Kc/s at 3 watts (distortion better than 1%); input requirements P.U. 12 mV., Radio 80 mV, tape 80 mV (radio and tape inputs are also suitable for higher output crystal cartridges); output imp. 8-16Ω; bass, treble and balance controls with switching for Mono or Stereo and tape monitor; outlet socket for tape recorder. For 115/250 v. A.C. mains. All circuits are fully fuse protected. Very compact free standing teak cabinet, size 13½ x 6½ x 4½in. with brushed aluminium front panel; all inputs and outlets are grouped at rear for easy access. Original List Price 25 gns.

**Lasky's Bargain Price £16.19.6.** Post & Pack, 10/-.

## SPECIAL INTEREST ITEMS!

### PHOTO ELECTRIC RELAY

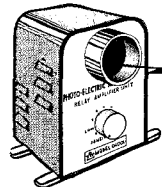

**MODEL Q4001**  
A new and inexpensive Photo Relay System—comprising "exciter" lamp and relay unit. Any interception of the light beam instantly triggers the relay which in turn will operate light, alarm bell or buzzer, electronic counter, heavy duty relay or electric motor. There are many interesting and useful applications for this system in the home, office, shop, factory, etc., i.e. people or object counting, alarm systems, door opening for garage or shop. Operates on 240V. A.C.; exciter lamp 12V. 20W. effective up to 15ft. in daylight or 80ft. at night or in low light. Very simple to install. In strong metal cases size (each) 6in. x 4½in. x 3in. Complete with mounting brackets wire and full instructions.

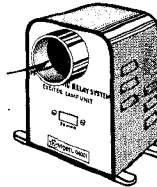

**Lasky's Price Only £7.19.6.** Post 5/-.

### High Fidelity Audio Centres

<b>42 TOTTENHAM CT. RD., LONDON, W.1</b>	Tel.: 01-580 2573
Open all day Thursday, early closing 1 p.m. Saturday	
<b>118 EDGWARE ROAD, LONDON, W.2</b>	Tel.: 01-723 9789
Open all day Saturday, early closing 1 p.m. Thursday	

# Lasky's Radio

## SENSATIONAL PURCHASE OFFER! CLOSED CIRCUIT TELEVISION

**NEW AND PERFECT BRITISH MADE EQUIPMENT  
AT LESS THAN HALF ORIGINAL COST!**

The FIRST Bargain Package of its type AND ANOTHER GREAT FIRST FOR LASKY'S! An extremely flexible closed-circuit system made by Britain's largest manufacturer of electronic equipment. The basic system comprises two units—camera and control monitor. The units are fully transistorised with a wide use of printed circuitry making for compact size, simple installation and high reliability (both in and out of doors). High sensitivity and 625 line resolution ensure excellent picture quality under normal lighting conditions. Closed circuit television provides the penetrating, all-seeing eye that scans, inspects, controls and directs—that is today accepted as invaluable in almost every aspect of industry, commerce, transport and education. A wide range of accessories are available which further increase the system's

## ALMOST LIMITLESS APPLICATIONS



**SYSTEM SPECIFICATION** Scanning standards: 625 line, 50 fields, 2:1 interlace. Horizontal resolution: 600 lines. Bandwidth 8 Mc/s over complete system. Linearity:  $\pm 2\%$  positional error. Geometry:  $\pm 2\%$  of rectangle averaged over picture. Auto Sensitivity: over the range 60:1 in light value—normal picture obtained with illumination of only 2ft. candles (50% subject reflectance) at lens aperture of  $f/2$ . Spectral Response: Panchromatic. Ambient Temperature: Max. temperature for all units  $-30^{\circ}\text{C}$ . to  $+55^{\circ}\text{C}$ . Power requirements 90/130 v. and 200/240 v. A.C., 50-60 c/s. Consumption: 45 watts including camera. Camera Lenses: Standard 16 mm. cine lenses with "C" mounts are normally used. Accessories: See under Camera and Control Monitor.

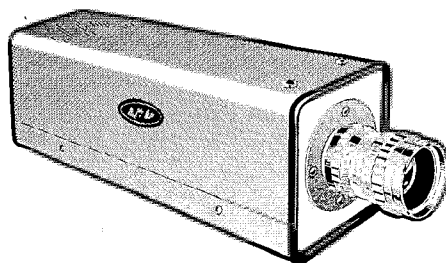

### CAMERA

Totally enclosed dustproof unit only  $3\frac{1}{2} \times 4 \times 10\frac{1}{2}$  in., weighing 4 lb. Finished in two-tone blue/grey. Vidicon tube. Automatic sensitivity control enables the camera to maintain full picture quality over a brightness range of 60:1. 625 line scanning standard 2:1 interlaced, frame synchronised to mains supply. 600 lines horizontal picture definition with a bandwidth of 8 Mc/s. All supplies are obtained from the control monitor (consumption 5 watts).

### CAMERA ACCESSORIES

Lenses: Superb quality 25 mm. (1 in.)  $f/1.8$ , "C" mount lenses made especially for this system are available, also a limited quantity of motorised zoom lenses.  
Remotely Controlled Weatherproof Pan and Tilt Heads: Pan  $340^{\circ}$  at  $6^{\circ}$  per sec., Tilt  $\pm 50^{\circ}$  at  $4^{\circ}$  per sec. 230/250 v., 50 c/s operated.  
Remotely Controlled Pan and Tilt for Indoor Use Only: Details as above.  
Weatherproof Camera Housing: Windscreen Wiper, 75 w. heater, internal circulation fan, mounting bracket for camera housing (the latter items are extras for the Weatherproof Housing).

### CONTROL MONITOR

14 in. screen, overall size  $16 \times 14 \times 18$  in. (excluding Remote Control Unit on which Monitor is shown), weight 30 lb. Panel controls provided: Mains on/off, Contrast, Brightness, Remote Focus. Preset controls (under side panels) include: Frequency lock, Monitor height, Frame linearity, Camera height, Camera width, Auto sensitivity, Camera linearity, Cable correction Video gain, Beam current, Y shift, Electrostatic focusing for camera and monitor. Additional input: Video  $-100$  mV peak white positive into 50 ohms; Synch.  $-2$  v. peak/peak negative. Output: 100 mV peak white positive; 2 v. peak/peak negative. Ambient temperature range  $-30^{\circ}\text{C}$ . to  $+55^{\circ}\text{C}$ .

### ACCESSORIES

Remote Control Switching Unit (shown under Control Monitor): Controls auxiliary functions at the camera, i.e. pan/tilt zoom, windscreen wiper, etc. Size  $18 \times 14 \times 3$  in., weight 8 lb.

Distribution Unit: Used for selecting the required picture from those available on the control monitors and distributing it to the appropriate viewing monitor. Size  $19\frac{1}{2} \times 13\frac{1}{2} \times 8\frac{1}{2}$  in., weight 30 lb.

Viewing Monitors: These are conventional domestic type receivers—19 in. and 23 in. models available.

Owing to the complexity and limited quantity of units available this equipment is available to CALLERS ONLY.

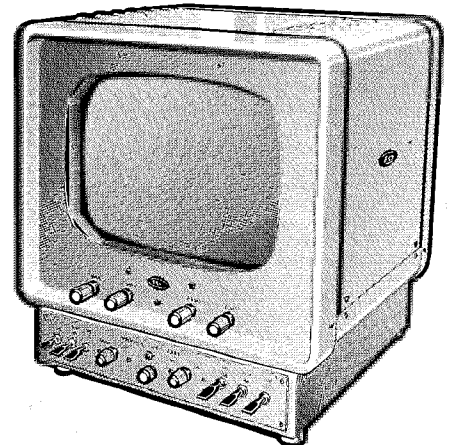

## LASKY'S BASIC SYSTEM PRICE ONLY 125 Gns.

1—camera (complete with Vidicon), less lens, 1—Control Monitor, 25 yds. of cable. PRICES FOR LENSES AND ACCESSORIES ON APPLICATION.

PLEASE NOTE—THESE SYSTEMS ARE AVAILABLE ONLY FROM OUR HEAD OFFICE  
3-15 CAVELL STREET, TOWER HAMLETS, LONDON, E.1 Tel. 01-790 4821/2

A demonstration system is available for your inspection by appointment.

WW—117 FOR FURTHER DETAILS





# SERVICE TRADING CO

Postage and Carriage shown below are inland only. For Overseas please ask for quotation. We do not issue a catalogue or list.

## LIGHT SENSITIVE SWITCHES

Kit and parts including ORP.12 Cadmium Sulphide PhotoCell. Relay Transistor and Circuit. Now supplied with new Siemens High Speed Relay for 6 or 12 volt operations. Price 25/-, plus 2/6 P. & P. ORP 12 and Circuit 10/- post paid.



## 220/240 A.C. MAINS MODEL

incorporates mains transformer rectifier and special relay with 3 X 5 amp. mains c/o contacts. Price inc. circuit 47/6, plus 2/6 P. & P.

## PHOTO ELECTRONIC COUNTER

Can be set for counts of up to 500 per minute. 210-250 v. A.C. powered. Kit of Components, including photo cell, high speed non-resettable counter, transformer, relay, etc., together with clear circuit diagram, £3/2/6, plus 3/6 P. & P. With resettable counter, £4/2/6, P. & P. 3/6.

## LIGHT SOURCE AND PHOTO CELL MOUNTING

Precision engineered light source with adjustable lens assembly and ventilated lamp housing to take MBC bulb. Separate photo cell mounting assembly for ORP.12 or similar cell with optic window. Both units are single hole fixing. Price per pair £2/15/0 plus 3/6 P. & P.

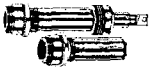

## UNIVERSAL DEMONSTRATION TRANSFORMERS

A complete composite apparatus, comprising a robustly built Transformer and electro-magnet with removable coils and pole pieces, coil tapped for 230 v., 220 v., 110 v., 115 v., 6, 12, 36, 110 v. A.C. These coils are also used for D.C. experiments. Complete with all accessories as shown. £19 plus 15/- carr. Leaflet on request.

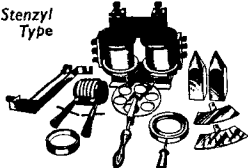

## A.C. CONTACTOR

2 make and 2 break (or 2 c/o) 15 amp. contacts. 230/240 v. A.C. operation. Brand new. 22/6 plus 1/- P. & P.



## 230/250 v. A.C. SOLENOID

Heavy duty type. Approx. 3lb. pull. 17/6 plus 2/6 P. & P.



## 12/24v. D.C. SOLENOID

Approx. 8oz. push. 8/6 plus 1/6 P. & P.

## SLIDER RESISTANCES

200 ohm 1.25 amp. 37/6. P. & P. 3/6. 5 ohm 10 amp. 37/6. P. & P. 3/6.

## RESETTABLE HIGH SPEED COUNTERS

3 figure, 0/999 24 v. D.C. operation (illustrated). Similar, but may be pre-set to any number up to 999 reducing to zero. Either type 32/6, P. & P. 2/6. 4 figure, 1,000 ohm coil, 36-48 v. D.C. operation, £3/10/- P. & P. 1/6.



## LATEST HIGH-SPEED MAGNETIC COUNTERS (NON-RESETTABLE)

4 figure, 10 impulses per second. Type 100A, 500 ohm coil. Type 100B, 2,300 ohm coil. Either 15/- each, plus 1/6 P. & P.

## SUPER POWER ALLOY MAGNET

These fantastic ex WD magnets weighing only 4lbs. will lift well over 100 lbs. Fitted with swivelled handle and keeper. Size 4in. X 3 3/4 in. X 1 1/2 in. Packed in original makers' cases of two. Price 30/- per pair, plus 7/6 P. & P.

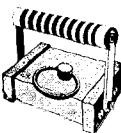

TRANSISTORISED MORSE OSCILLATOR. Fitted 2 1/2 in. Moving Coil Speaker. Uses type PP3 or equiv. 9 v. battery. Complete with latest design Morse key. 22/6, plus 1/6 P. & P.

## 34R SILICON SOLAR CELL

4 x .5 volt unit series connected, output up to 2 v. at 20 mA. in sunlight, 30 times the efficiency of selenium. As used in power Earth Satellites, 39/6. P. & P. 1/6d.

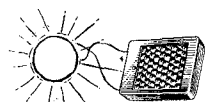

## "SOLAR CELL AND PHOTO-CELL EXPERIMENTERS' GUIDE"

Teaches the principles of light sensitive devices and their application. 26/- post paid.

## GENUINE NEW MULLARD 6AM SILICON DIODES. Not Rejects or Seconds.

BYZ13 200 PIV ..... 7/- BYZ12 400 PIV ..... 8/-  
BYZ11 600 PIV ..... 9/- BYZ10 800 PIV ..... 10/-

## NICKEL CADMIUM BATTERY

Sintered Cadmium Type 1.2 v. 7AH. Size: height 3 1/2 in., width 2 1/2 in. X 1 1/2 in. Weight: approx. 13 ozs. Ex-R.A.F. Tested 12/6. P. & P. 2/6.

## 100 WATT POWER RHEOSTATS



(NEW) Ceramic construction, winding embedded in Vitreous Enamel, heavy duty brush assembly designed for continuous duty.

### AVAILABLE FROM STOCK IN THE FOLLOWING 12 VALUES:

1 ohm 10a., 5 ohm 4.7a., 10 ohm 3a., 25 ohm 2a., 50 ohm 1.4a., 100 ohm 1a., 250 ohm 7a., 500 ohm 45a., 1,000 ohm 280mA., 1,500 ohm 230mA., 2,500 ohm .2a. Diameter 3 1/2 in. Shaft length 2 1/2 in. dia. 1 1/2 in., 27/6. P. & P. 1/6.  
50 WATT 1/5/10/25/50/100/250/500/1,000/1,500/2,500 ohm. 21/-. P. & P. 1/6.  
25 WATT 10/25/50/100/250/500/1,000/1,500/2,500 ohm. 14/6, P. & P. 1/6.

## VENNER ELECTRIC TIME SWITCH

200-250 v. A.C. 20 amp. contacts twice on, twice off, at any manually pre-set time. Spring reserve (in case of power cut) fully tested, £3/9/6. P. & P. 4/6. Or complete in weather-proof metal case (illustrated). £3/19/6. Plus 4/6 P. & P. Can be supplied with solar dial, on at dusk—off at dawn. Prices as above.

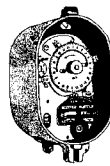

## RADIO ALTIMETER

This precision Instrument, built to highest Ministry specification, is based on a 24 v. D.C. LOW INERTIA (Integrating) Motor. The Motor, fitted with gold brushes and drawing only 800 microamp at 24 v. D.C. drives two precision pots with platinum wipers through close tolerance gear-trains, including miniature slipping clutch, combined with two sub-miniature pots for calibrating the electrical bridge circuit. The 3in. calibrated dial, with a number aperture indicating one rev. per revolution of pointer with maximum of 5 revs., gives an effective scale length of approx. 30in. Offered at fraction of Manufacturer's price: 32/6, plus 6/- P. & P.

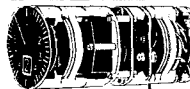

## SANWA MULTI RANGE METERS

Acknowledged throughout the world as the ultimate in test meters.

NEW MODEL U-50D MULTI-TESTER, 20,000 O.P.V. MIRROR SCALED WITH OVERLOAD PROTECTION. Ranges: D.C. volts: 100mV., 0.5 v., 5 v., 250 v., 1,000 v. A.C. volts: 2.5 v., 10 v., 250 v., 250 v., 1,000 v. D.C. current: 5µA. 0.5mA., 5 mA., 50 mA., 250mA. Size: 5 1/2 x 3 1/2 x 1 1/2 in. Complete with batteries £7.50 Post paid.



Three other models available from stock. Descriptive leaflet on request.

## 220/240v. A.C. COOLING UNIT

2,300 r.p.m. 6in. blade size. Smooth powerful motor. All metal construction. Continuously rated. Individually tested. Offered at fraction of maker's price, £2/15/- P. & P. 7/6.

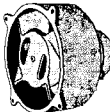

## THYRISTOR 400 p.v., 5 amp., 14/6 post paid.

## THYRISTOR 400 p.v., 8 amp., 28/6 post paid.

## SANGAMO WESTON

Dual range voltmeter. 0-5 and 0-100 v. D.C. FSD 1 mA. In carrying case with tests prods and leads. 32/6. P. & P. 3/6.



AUTO TRANSFORMERS. Step up, step down. 110-200-220-240 v. Fully shrouded. New. 300 watt type, £3 each. P. & P. 4/6. 500 watt type, £4/2/6 each. P. & P. 6/6. 1,000 watt type, £5/5/- each. P. & P. 7/6.

## PRECISION INTERVAL TIMER

From 0-30 seconds (repetitive). Jewelled balanced movement. Lever re-set. Operates 230 v. A.C. 5 amp. c/o micro-switch. Brand New 17/6 plus 2/6 P. & P.

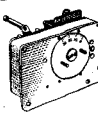

## 20 amp. LEVER MICRO SWITCH

Brand new lever operated micro switch. 20 amp. A.C. c/o contacts. Price 4/6 each plus 1/6 P. & P. 5 for £1 post paid.



## 50k 45 TURN PRECISION WIREWOUND CONTROL

Fly leads. 1 1/2 x 1/2 x 1/2 in. made by M.E.C. Ltd. 10/- post paid.

## LATEST TYPE SELENIUM BRIDGE RECTIFIERS

30 volt 3 amp., 11/-, plus 2/6 P. & P.  
30 volt 5 amp., 16/-, plus 2/6 P. & P.

## MOVING COIL HEADPHONE AND MIKE

Soft rubber ear-pieces with M/C Mike fitted 5-way plug as on No. 19 set. New, in maker's packing, 16/6, plus 3/6 C. & P.

## A.C. AMMETERS 0-1, 0-5, 0-10, 0-15, 0-20 amp. F.R.

2 1/2 in. dia. All at 21/- each.

## A.C. VOLTMETERS 0-25 v., 0-50 v., 0-150 v. M.I.

2 1/2 in. Flush round all at 21/- each. P. & P. extra.

## 0-300 v. A.C. Rect. M-Coil 2 1/2 in. .... 29/-

0-300 v. A.C. Rect. M-Coil 3 1/2 in. Type W23 ..... 55/-

## LATEST TYPE VARLEY MINIATURE RELAY

in Transparent Case. 4 c/o 700 ohm. 15/-. Base 4/- 2 c/o 700 ohm coil. Size 3/8 x 3/8 x 1 3/8 in. 12/6, inc. base. VARLEY TYPE VP4 (similar to illus.) 5,800 ohm 4 c/o. New, 12/6, less base. Similar to above. Mfd. by GRUNER 4 c/o, 2,400 ohm coil. New, 10/-, less base.

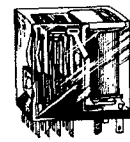

230v. A.C. RELAY 2 c/o one make by Magnetic Devices Ltd. 11/6, 1/- P. & P.

## UNISELECTOR SWITCHES

### NEW 4 BANK 25 WAY

25 ohm coil, 24 v. D.C. operation. £4/17/6, plus 2/6. P. & P.



### 8-BANK 25-WAY FULL WIPER

24 v. D.C. operation, £6/10/-, Plus 4/- P. & P.

## UNISELECTOR SWITCHES USED

75 ohm coil, 24 v. D.C., 6 bank 25 position, 5 non-bridging, 1 bridging wiper. 6 bank arranged to give 3 bank, 50 positions ex-equipment, 35/- each. P. & P. 2/6.

## MINIATURE UNISELECTOR SWITCH



3 banks of 11 positions, plus homing bank. 40 ohm coil. 24-36 v. D.C. operation. Carefully removed from equipment and tested. 22/6, plus 2/6 P. & P.



## INSULATED TERMINALS

Available in black, red, white, yellow, blue and green. New 17/- per doz. P. & P. 2/-.

## CONDENSERS

New at a fraction of makers price.  
2,500 mfd. 100 v. 12/6 P. & P. 1/6.  
4,000 mfd. 25 v. 10/- P. & P. 1/6.  
4,000 mfd. 50 v. 15/- P. & P. 1/6.  
10,000 mfd. 35 v. 15/- P. & P. 1/6.

## SOLAR OIL-FILLED CONDENSER.

240 mfd. for 230 V.A.C. or 600 volt D.C. Overall size 1 1/2 in. x 9 in. x 5 1/2 in. plus feet. Weight 46 lb. Guaranteed perfect. Manufacturer's packing. Price £7/10/-. Carriage 15/-.

## 230 VOLT A.C. GEARED MOTORS

Type D15G 5 r.p.m. 1.71b. inch, £2/9/6. P. & P. 3/-  
Type B16G 80 r.p.m. 2.61b. inch, £2/2/-, P. & P. 3/-  
Type D16G 13 r.p.m. 1.451b. inch, £2/17/6. P. & P. 3/-.

## GALVANOMETER

300-0-300 microamp. Calibrated 30-0-30. Mounted in sloping front case £2/10/- P. & P. 3/6. D.C. Voltmeter 0-3 V. and 0-15 V. £2 plus 3/6 P. & P. D.C. Ammeter, 0-6 amp. and 0-3 amp. £2, 3/6 P. & P. The set of 3 matching instruments £6, P. & P. 6/6.

## DRY REED SWITCHES

New special offer of Dry Reed Switches, 1/2 amp. contact, 1 1/2 x 1 1/2 in., 4 for 10/-, post paid.

## NEW SOUNDPOWER OPERATED EX-ADMIRALTY HEAD AND BREAST SETS

Two such sets connected up will provide perfect intercom. No batteries required. Will operate up to 1/2 mile. Price 17/6 each, plus P. & P. 4/6, or 32/6 per pair. P. & P. 6/-.



## S.T.C. SILICON POWER RECTIFIERS

RS300 Series. All types 1.5 amp. wire ended.  
RS310, 100 v. P.I.V. 4/- RS350, 500 v. P.I.V. 8/-  
RS330, 300 v. P.I.V. 6/- RS360, 600 v. P.I.V. 9/-  
RS340, 400 v. P.I.V. 7/- RS380, 800 v. P.I.V. 10/-  
4 can be used to make 3 amp. bridge. Not Seconds. Brand New Stock. Post paid.

ALL MAIL ORDERS. ALSO CALLERS AT:

ST BRIDGHAN ROAD, LONDON, W.4. Phones: 795 1560. Closed Saturdays.

**SERVICE TRADING CO.**  
SHOWROOMS NOW OPEN  
Many Bargains for the caller.  
AMPLE PARKING

PERSONAL CALLERS ONLY

9 LITTLE NEWPORT STREET, LONDON, W.C.1. Tel: GER 0576

# SURPLUS SEMICONDUCTORS

Manufacturers Over-Runs and Surplus Devices at a Fraction of Manufacturing Cost. We are QUANTITY DISPOSAL AGENTS for the Manufacturer, and offer the Largest and Cheapest Range of Transistors, Diodes, etc. For use in Industry, Teaching, and Amateur Electronics.

**HIGH QUALITY SILICON PLANAR DIODES.** SUB-MINIATURE DO-7 Glass Type, suitable replacements for OA200, OA202, BAY38, IS130, IS940. 200,000 to clear at £4 per 1,000 pieces. GUARANTEED 80% GOOD.

**SUPERB QUALITY TESTED SILICON PLANAR DIODES** (Surplus Govt project). 250mA 150-200 p.i.v. DO-7 sub-min glass, finished black eqvt. OA202 IS923, MS4H, HS3132. 75,000 only available at:— 100 pieces, £2/10/-; 500 pieces, £9; 1,000 pieces, £15.

**MICRO-MINIATURE SILICON FAST-SWITCHING DIODES.** Type IN914. QUALITY TESTED. 75 p.i.v. 75mA. 100,000 available. 100 pieces, £2; 500 pieces, £7/10/-; 1,000 pieces, £12/10/-.

**GERM. GOLD BONDED DIODES.** High quality subminiatures DO-7 Glass 80% good devices guaranteed. Substitutes for OAS, OA47, LG80H, CG 90H 150,000 to clear at £4 per 1,000 pieces.

**VAST MIXED LOT OF SUBMINIATURE GLASS DIODES.** COMPRISING OF SILICON GERM. POINT CONTACT AND GOLD BONDED TYPES PLUS SOME ZENERS. 500,000 available at Lowest of Low Price. 1,000 pieces, £3; 5,000 pieces, £13/10/-; 10,000 pieces, £23.

**BRAND NEW FULLY TESTED EPOXY CASE UNIJUNCTION TRANSISTORS.** Type similar to TIS43 and BEN3000 and replacement for 2N2646 Full date available. LOWEST PRICE AVAILABLE ANYWHERE. 100 off 4/- each ... £20; 500 off 3/6 each = £87/10/-; 1,000 off 3/- each = £150. Sample devices 7/- each on request.

**TEXAS SILICON ALLOY TRANSISTORS.**

2S302 Eqr.	OC200 VcB40 Hfe 15-50	1.49 off 3/6 each
2S303	OC201 VcB25 Hfe 25-75	5.99 off 3/- each
2S304	OC202 VcB15 Hfe 45-120	100 off 2/6 each

 ALL BRAND NEW FULLY GUARANTEED AND MARKED.

**GERM ALLOY AF TRANSISTORS PNP.** Manufacturers fall out, ideal OC71-OC75 OC81 type from 2G300 Series untested, approximately 80% good. 500 off, £7/10/-; 1,000 off, £12/10/-.

**MIXED LOT OF TRANSISTORS ALL GERM. MAINLY PNP.** AF/R 50% good. Further 35% good for diodes, only 50,000 left out of 2,000,000. Ridiculous price of £3. Per 1,000.

**MIXED SILICON PLANAR TRANSISTORS NPN TO-18 CASE.** Transistors to fill a number of requirements like 2N706, 2N708, BSY27, BSY95A, etc. 500 off, £5; 1,000 off £8/10/-.

Terms. **CASH WITH ORDER**, all goods sent by return. Please add 2/6 towards post and packing. Monthly accounts for educational authorities, etc. on receipt of an official Order.

EXPORT ORDERS AND ENQUIRIES RECEIVE IMMEDIATE ACTION.

All correspondence, cheques, postal orders, etc., to:—

Diotran Sales,  
P.O. BOX 5, 63 HIGH STREET, WARE, HERTS. Tel.: WARE 3442

**ORGAN BUILDERS;** N.P.N. Sil. Planar Transistors. All Tested, 1/6 each, or £5.0.0 per 100.

**TRANSISTOR BARGAIN SALE; NEW STOCK AT UNBEATABLE PRICES;**

OC44, OC45, OC81D now only	1/6 each!	£6.0 per 100
OC71, OC72 equivalent	1/- each!	£3.0.0 per 100
ASV22 Switching Transistors	2/6 each!	£10.0.0 per 100
2N753 N.P.N. Silicon Planar, 300mW. 250Mc/s. High speed switching	2/6 each!	
BSV28 N.P.N. Silicon Planar, Epitaxial, 300mW. 300Mc/s	2/6 each!	
BSV65 N.P.N. Silicon Planar, Epitaxial, 800mW. 100Mc/s	2/6 each!	
AFZ12 P.N.P. Germanium Alloy Diff. low noise V.H.F. amplifier	2/6 each!	

Complete sets of transistors for radio:

2G344A/2G345A/2G345B/2G371A/2G378A + diode	10/- each!
GE7120, 2 watts. Heat sink included	2/6 each!
Transistor Driver Transformers	2/6 each!
Transistor Output Transformers (suitable for our kits above)	2/6 each!
OC28	5/- each!

BYZ13, 6 amp rectifiers SPECIAL REDUCED PRICE! ONLY 2/6 each; 24/- doz.; £7.10.0 per 100; £50.0.0 per 1,000. Light sensitivity transformers similar to OCP71

UNMARKED, UNTESTED TRANSISTORS TO CLEAR ... 7/6 for 50! Silicon diodes. Make excellent detectors. Also suitable for keying electronic organs, 1/- each; 20 for 10/-.

BY100 type rectifiers. SPECIAL REDUCED PRICE! ONLY 2/6 each; 24/- doz.; £7.10.0 per 100; £50.0.0 per 1,000.

## ELECTROLYTIC CONDENSER FANTASTIC SELECTION:

.025μF .. 3 volt	5μF .. 25 volt	64μF .. 2.5 volt
1μF .. 350 volt	6μF .. 3 volt	64μF .. 9 volt
1.25μF .. 16 volt	8μF .. 3 volt	100μF .. 3 volt
2μF .. 3 volt	8μF .. 6 volt	100μF .. 6 volt
2μF .. 9 volt	8μF .. 50 volt	100μF .. 9 volt
2μF .. 70 volt	8μF .. 275 volt	150μF .. 12 volt
2μF .. 150 volt	10μF .. 25 volt	200μF .. 3 volt
2μF .. 350 volt	16μF .. 150 volt	200μF .. 4 volt
2.5μF .. 16 volt	20μF .. 3 volt	250μF .. 2.5 volt
2.5μF .. 25 volt	20μF .. 6 volt	250μF .. 9 volt
3μF .. 3 volt	20μF .. 9 volt	320μF .. 2.5 volt
3μF .. 25 volt	20μF .. 15 volt	250μF .. 9 volt
3.2μF .. 6.4 volt	25μF .. 6 volt	350μF .. 10 volt
3.2μF .. 64 volt	25μF .. 12 volt	400μF .. 2.5 volt
4μF .. 4 volt	25μF .. 25 volt	400μF .. 15 volt
4μF .. 12 volt	30μF .. 6 volt	500μF .. 4 volt
4μF .. 25 volt	30μF .. 10 volt	500μF .. 6 volt
4μF .. 100 volt	40μF .. 3 volt	640μF .. 2.5 volt
6μF .. 6 volt	50μF .. 9 volt	750μF .. 12 volt

All at 1/- each. Mixed Packets of 20 (our selection) 10/-.

## PAPER CONDENSERS

0.001μF .. 500 volt	0.02μF .. 600 a.c.	0.25μF .. 350 volt
0.001μF .. 1,000 volt	0.02μF .. 350 volt	0.5μF .. 350 volt
0.002μF .. 500 volt	0.1μF .. 350 volt	0.5μF .. 500 volt
0.005μF .. 750 volt		

All at 15/- per 100. 3/- per dozen. Mixed Bags of 100 (our selection) 10/-.

## MULLARD POLYESTER CAPACITORS. ALL HALF PRICE

0.0022μF 400 volts	4d.	0.15μF 160 volts	7d.
0.0018μF 400 volts	4d.	0.22μF 160 volts	7d.
0.0015μF 400 volts	4d.	0.27μF 160 volts	7d.
0.001μF 400 volts	4d.	0.05μF 125 volts	7d.
0.01μF 400 volts	4d.	1μF 125 volts	1/6
68pF Tubular pulse ceramic, each	6d.		

**VERY SPECIAL VALUE!** Silver Mica, Ceramic, Polystyrene Condensers. Well assorted. Mixed types and values, 10/- per 100.

**RESISTORS. Give-away offer; Mixed types and values, 1/2 to 1/2 watt, 6/6 per 100 or 55/- per 1,000.** Also 1/2 to 3 watt close tolerance. Mixed values, 7/6 per 100; 55/- per 1,000.

## WIRE-WOUND RESISTORS

1 watt, 8 watt, 6 watt, 6d. each; 7 watt and 10 watt, 9d. each. 20 assorted, 10/-.

## CONNECTING WIRE. THIN, P.V.C. INSULATED

10yd., 1/-; 100yd., 7/6; 500yd., 25/- (post 4/6); 1,000yd., 40/- (post 6/-).

## VALVES. BRAND-NEW AND BOXED. ROCK-BOTTOM PRICES:

DY87 .. 6/9	EY51 .. 6/9	PCL85 .. 9/5
EABC80 .. 7/-	EY86 .. 6/9	PCL86 .. 8/5
ECC82 .. 7/4	PABC80 .. 6/9	PFL200 .. 11/8
ECC83 .. 7/4	PC97 .. 7/1	PL36 .. 10/1
ECL80 .. 7/1	PC98 .. 10/6	PL81 .. 8/5
ECL86 .. 7/1	PCC84 .. 7/4	FL83 .. 8/5
EP80 .. 8/5	PCC88 .. 10/6	PL84 .. 6/6
EP85 .. 7/1	PCF80 .. 8/5	PL500 .. 12/5
EP86 .. 7/1	PCF86 .. 10/1	PY32 .. 8/-
EP183 .. 9/5	PCL82 .. 8/5	PY81 .. 6/9
EP184 .. 9/5	PCL83 .. 9/10	PUS2 .. 4/9
	PCL84 .. 8/5	PY800 .. 6/9

A further 10% discount will be given on lots of 50 of any one type.

## RECORD PLAYER CARTRIDGES

Acos GP67/29 Mono, 15/-; Acos GP91/35C Stereo compatible, 20/-; Acos GP94/1 Stereo, 25/-. All with needles.

## TRANSISTORISED SIGNAL INJECTOR KIT, 10/-, SIGNAL TRACER KIT, 10/-

## VEROBOARD. All sizes in stock.

2 1/2in. x 1in. 0.15 matrix	1/1	17in. x 3 1/2in. 0.15 matrix	14/8
2 1/2in. x 3 1/2in. 0.15 matrix	3/3		
2 1/2in. x 5 1/2in. 0.15 matrix	2/11	5in. x 5 1/2in. 0.1 matrix	3/11
3 1/2in. x 3 1/2in. 0.15 matrix	3/11	3 1/2in. x 2 1/2in. 0.1 matrix	3/9
3 1/2in. x 5in. 0.15 matrix	5/6	5in. x 3 1/2in. 0.1 matrix	5/2
17in. x 2 1/2in. 0.15 matrix	11/-	3 1/2in. x 3 1/2in. 0.1 matrix	3/11

## SPECIAL OFFER:

Cutter and 5 Boards 2 1/2in. x 1in., 9/9. Cutter only, 7/6. Pin Insert Tool, 9/6. Terminal Pins. Packet of 36, 3/6.

## BARGAIN OFFER:

Few only Multimeters, 1,000Ω per volt, 45/-; 20,000Ω per volt, 80/-.

Orders by post to:—

**G. F. MILWARD, 17 PEEL CLOSE, DRAYTON BASSET, Staffs.**

Please include suitable amount to cover postage. Stamped addressed envelope must be included with any enquiries. Regret unable to accept orders below 10/- by post. For customers in the Birmingham area goods may be obtained from Rock Exchanges 231 Alum Rock Road, Birmingham, 8. (All POST orders to Drayton.)

## A.C. SOLENOID TYPE SRM

Continuous Rating  
7lb. at 1 1/2 in  
Instantaneous  
up to 14lb.

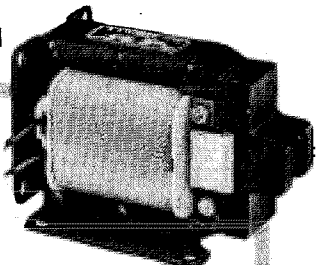

Smaller sizes available—also transformers to 8kVA 3-phase.

**R. A. WEBBER LTD.**

KNAPPS LANE, CLAY HILL, BRISTOL 5. TELEPHONE 65-7228/9

WW-113 FOR FURTHER DETAILS

Your choice of  
Live Sockets -  
Instantly!

A Lexor DIS-BOARD gives you up to 6 sockets from one power outlet. Portable or permanent fixing, compact units, with safety neon. Over 1,000 socket combinations available from stock. All types of fittings and finishes.

brochure from  
LEXOR DIS-BOARDS LIMITED,  
Allesley Old Road, Coventry.  
Telephone 72614 or 72207

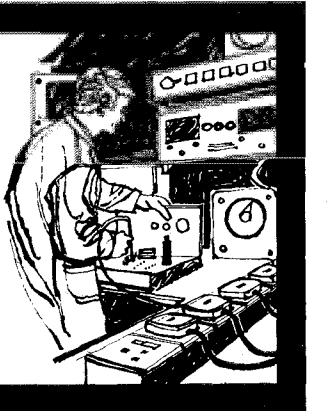

WW-114 FOR FURTHER DETAILS

# SOLID STATE HIGH FIDELITY AUDIO EQUIPMENT

POWER AMPLIFIERS — PRE-AMPLIFIERS/CONTROL UNITS — POWER SUPPLIES — BRITISH MADE



▼ MP3



◀ SP4-A

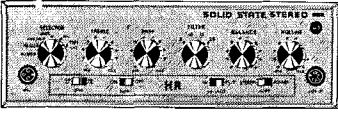

▼ SP6-2

- MP3 mono preamplifier/control unit  
**£6.19.6** p.p. 3/-
- SP4-A mono-stereo version of MP3  
**£11.19.6** p.p. 4/6
- SP6-2 mono/stereo (takes mag. pick-up as well).  
**£15.10.0** p.p. 5/-
- MPA12/3 12 watt amplifier. 3 to 5 ohm output.  
**£4.10.0** p.p. 2/6
- MPA12/15 12 to 16 ohm. 12 watt. Amplifier.  
**£5.5.0** p.p. 2/6
- MPA25 25-30 watt amplifier for 7 1/2-16 ohm speaker.  
**£7.10.0** p.p. 3/6
- PS24/40 power supply for MPA12/3 and MPA12/15.  
**£3.12.6** p.p. 3/-
- MU24/40 choke version.  
**£4.10.0** p.p. 3/6
- MU60 power supply for MPA25  
**£4.17.6** p.p. 4/6

All systems complete with grey/silver panels and matching silver knobs. Audio Equipment developed from Dinsdale Mk. II—each unit or system will compare favourably with other professional equipment selling at much higher prices. Brief details are below:

Complete suggested systems		Price
1A	MP3+MPA12/3+MU24	£15.5.0 p.p. 5/-
2A	MP3+MPA12/15+MU40	£18.0.0 p.p. 5/-
4	MP3+(2) MPA12/15+MU40	£21.2.6 p.p. 7/-
6	MP3+MPA25+MU60	£18.15.0 p.p. 7/-
8A	SP4-A+(2) MPA12/15+MU40	£26.0.0 p.p. 8/6
10	SP6-2+(2) MPA12/15+MU40	£28.5.0 p.p. 8/6
12A	SP4-A+(2) MPA25+(2) MU60	£35.10.0 p.p. 10/-
13	SP6-2+(2) MPA25+(2) MU60	£38.17.6 p.p. 10/-

16 PAGE BROCHURE ON REQUEST No. 21  
All units sold separately.

THE FINEST VALUE IN HIGH FIDELITY—CHOOSE A SYSTEM TO SUIT YOUR NEEDS AND SAVE POUNDS

COMPLETE RANGE OF SUITABLE PLAYER DECKS, SPEAKERS AND TUNERS IN STOCK.—ASK FOR LATEST LIST 16

## NEW! INTEGRATED 7 WATT AMPLIFIER AND PRE-AMPLIFIER — MA 7

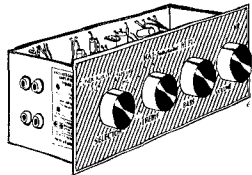

New design for 8 to 10 ohm speakers. Input for mag. xcal/ceramic pu's. Tape, tuner, mic., etc. Battery operated or mains unit. Full Treble/Bass controls. 8 transistor design.

PRICE **£8.10.0** P.P. 4/-

Leaflet on request. (Mains int PS20 62/6, P.P. 3/-)

## BUILD A QUALITY TAPE RECORDER WITH MARTIN RECORDAKITS

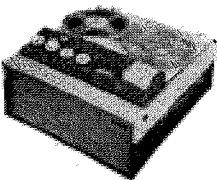

★ TWO-TRACK Deck Amplifier. Cabinet and Speaker. Complete kits with MICROPHONE and 7in. 1,200ft. tape, spare spool. Today's Value **£55.**

**36 gns.** P.P. 2/6

★ FOUR-TRACK Deck. Amplifier. Cabinet and Speaker. Complete kits with MICROPHONE and 7in. 1,200ft. tape, spare spool. Today's Value **£80.**

**39 gns.** P.P. 2/6

## GARRARD DECKS all the LATEST MODELS



COMPLETE RANGE IN STOCK FROM **£6.10.0**  
Send for illustrated Brochure 16&17

## SERVICES TYPE 4185 SOUND RECORDING APPARATUS (Boosey and Hawkes Model 49)

Complete wire recorders primarily designed for aircraft use but suitable for any 21 or 29 volt 1.4 amp. D.C. supply. Supplied complete with wire and instruction leaflet.

Brand New 89/6. Carriage 5/- 1/2 lb. Reels of Wire 15/-

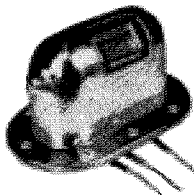

**GRAVINER FIRE DETECTOR UNIT**  
Containing 931A Photo Multiplier and Network with Cold Cathode Relay—totally enclosed in metal case 4x3x2 1/2 in. Original price £74.

**OUR PRICE, BRAND NEW £6 each,** with data sheet. Limited quantity available.

## MAYFAIR PORTABLE



## ELECTRONIC ORGAN

Also **READY BUILT AND TESTED 128 gns.** Deferred terms available. DEPOSIT £36.8.0 and 12 monthly payments of £9. Total £144.8.0. KIT OF PARTS Deferred terms: DEPOSIT £29/19/- 12 monthly payments of £7. **TOTAL COST £113/19/-**

**ORGAN COMPONENTS** We carry a comprehensive stock of organ components for TRANSISTOR AND VALVE FREE PHASE designs. Brochure 10.

**TOTAL COST TO BUILD 99 GNS.**

- ★ Build this instrument stage by stage in your own home.
- ★ A truly portable instrument for all enthusiasts.
- ★ Fully TRANSISTORISED POLYPHONIC, British design. **ON APPLICATION**
- ★ Call in for a DEMONSTRATION and see for yourself. **EXPORT PRICES**

# HENRY'S RADIO LTD.

303 EDGWARE ROAD, LONDON, W.2  
AND 309 EDGWARE ROAD, LONDON, W.2

## TRANSISTORS-SEMICONDUCTORS

COMPLETELY NEW 1968 LIST OF 1000 types available from stock. Send for your FREE COPY TODAY (List No. 38).

- ★ S.C.R.'s, from 5/-
  - ★ FIELD EFFECT TRANSISTORS, from 9/6
  - ★ POWER TRANSISTORS, from 5/-
  - ★ DIODES and RECTIFIERS, from 2/-
- 24 page Illustrated Brochure as above including CIRCUITS & DATA LISTING 2000 DEVICES, 1/- post paid.

## NEW LIST OF VALVES OR CRYSTALS 24 PAGE BOOKLET 1/-

### MARTIN FM TUNER



- Mullard 6-Transistor design.
  - Tuning range 88 to 108 Mc/s.
  - Response 30 c/s to 15,000 c/s.
  - Automatic frequency counter.
  - Factory built and aligned units—Just interconnect.
  - 9 Volt Battery Operated. (12 mA)
- Send for Brochure No. 8.  
Total cost £14/14/-. P.P. 2/6  
FOR USE WITH ANY VALVE OR TRANSISTOR AMPLIFIER

## BUILD A:— INTEGRATED CIRCUIT F.M. TUNER

Using the R.C.A. CA3014 Module utilising 15 transistors and diodes. **Total cost of all parts £5.2.6,** post 2/6. Circuit and layout diagrams 1/- (free with parts). Ask for List 40A.

## PRECISION WIREWOUND GEARED PRESET CONTROLS

Gearing approximately 46 turns of end screw to cover full track. Low noise. Full sealed with 3-lead out wires or tags and two hole fixing. Overall size 1 1/4 x 1/2 x 3/8 in. Made by M.E.C. Ltd.

SIZES AVAILABLE: 10, 20, 50, 100, 200, 250, 500 ohm. 1K, 2K, 5K, 10K, 20K, 25K, 50K, 100K ohm. 10/- each.



## NEW MODELS NOMBREX TRANSISTORISED Test Equipment

MODEL	PRICE	Leaflet No.
28 Power Supply	£14	22
30 Audio Generator	£16/10/-	24
31 R.F. Generator	£12/10/-	25
32 C.R. Bridge	£10/10/-	26
33 Inductance Bridge	£20	29
27 Signal Generator	£10/10/-	14
66 Inductance Bridge	£18	14

Send for descriptive illustrated Brochure All units POST PAID including Battery



M&LW QUALITY TRANSISTOR RADIO TUNER Fully tunable superhet with excellent sensitivity and selectivity. Output up to 1/2 volt peak. Complete with front panel, etc. 9 volt operated. For use with any amplifier or tape recorder.

Ask for Brochure 5

TOTAL COST TO BUILD **£3.19.6** P.P. 2/6



VHF FM TUNER 87/105 Mc/s Transistor Superhet. Gearing tuning. Terrific quality and sensitivity. For valve or transistor amplifiers. 4 x 3 1/2 x 2 1/2 in. Complete with dial plate. 5 Mullard Transistors, plus 4 Diodes. Ask for Brochure 3.

TOTAL COST TO BUILD **£6.19.6** P.P. 2/6

## FM STEREO DECODER



7 Mullard Transistors, Printed Circuit Design with Stereo Indicator. For use with any valve or transistor FM. Uses pot cores to Mullard design and ger. and silicon transistors.

As used by B.B.C. and G.P.O. COMPLETE KIT PRICE **£5.19.6**

Ask for Brochure 4. P.P. 2/6

## PORTABLE GEIGER COUNTERS

FOR MEASUREMENT OF RADIO-ACTIVITY. Supplied complete with instructions, haversack, cables and probe. List price £70. **OUR PRICE, NEW, TESTED, COMPLETE WITH BATTERIES**

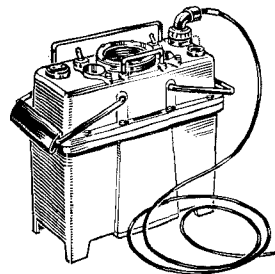

COMPLETE WITH BATTERIES

**£7.10.0** POST 10/-

SPARE BATTERIES 15/- PAIR. POST 5/-

## COMPLETELY NEW 1968 9th EDITION

# CATALOGUE

The most COMPREHENSIVE—CONCISE—CLEAR—COMPONENTS CATALOGUE Complete with 10/- worth discount vouchers FREE WITH EVERY COPY.

- ★ 30 pages of transistors and semiconductor devices, valves and crystals.
- ★ 200 pages of components and equipment.
- ★ 65 pages of microphones, decks and Hi-Fi equipment.

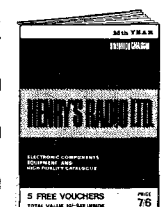

Send today **8/6** POST PAID

WE CAN SUPPLY FROM STOCK MOST OF THE PARTS SPECIFIED ON CIRCUITS IN THIS MAGAZINE. SEND LIST FOR QUOTATION.  
PHONE 01-723 1008/9  
OPEN MON-SAT. 9 a.m.-6 p.m.  
THURS. 9 a.m.-1 p.m.

# SENSATIONAL VALUE IN HIGH FIDELITY STEREO SYSTEMS

## 'Plan 3' 30 Watt System

- ★ Goldring Transcription Turntable
- ★ Shure Magnetic P.U. Cartridge.
- ★ Super 30 Amplifier.
- ★ E2 Equipment Cabinet.
- ★ Pair of Stanton Mk. IIS L/Speaker Units.



Special inclusive price. Fully wired units ready to "plug in." Saving £19 on total cost. Send S.A.E. for leaflet. Carr. 35/-.

**79½ Gns.**

Extremely attractive cabinets finished in Satin Teak Veneer. Tinted Perspex hinged lid with satin chrome handle.

## 'Plan 2' 30 Watt System

- ★ Garrard SP25 Mk. II Turntable.
- ★ Goldring CS90 Ceramic P.U. Cartridge.
- ★ Super 30 Amplifier.
- ★ E2 Equipment Cabinet.
- ★ Pair Stanton Mk. IIS L/Speaker Units



Special inclusive price. Fully wired units ready to "plug in." Saving £18 on total cost. Send S.A.E. for leaflet. Carr. 35/-.

**72 Gns.**

Inc. Garrard SP25 Mk. II 4-speed Player Unit (with heavy cast turntable mounted on plinth with leads and plugs and fitted Goldring CS90 high compliance ceramic cartridge with diamond stylus. Assembled TA12 Stereo Amplifier in cabinet and pair of Dorset Speaker Units. Special inclusive price Saving £12 on total cost. Carriage 35/-.

**47 Gns.**

Perspex cover 59/9 extra with above only. Or Dep. £27/6- and 9 monthly payments 25/3- (Total £53/13-).

## AUDIOTRINE HIGH FIDELITY LOUDSPEAKERS

Heavy cast construction. Latest high efficiency ceramic magnets. Treated cone surround giving low fundamental resonance. "D" indicates frequency range. One providing extended frequency range of 20 to 15000 c.p.s. Response 40-18,000 c.p.s. Highly recommended models capable of outstanding performance. Exceptional value.

Following super efficient types have rolled rubber surround and 16,000 line ceramic magnet. Response 30-20,000 c.p.s.

**HF850D 8" x 5" 8 watt £2 9**   **HF120 12in. 15 watt £3 9**  
**HF800D 8in. 8 watt £2 19**   **HF120D 12in. 15 watt £3 19**  
**HF811D 8in. 10 watt £4 19**   **HF126 12in. 15 watt £4 9**  
**HF101D 10in. 15 watt £5 19**   **HF126D 12in. 15 watt £5 9**

**RECORD PLAYING UNITS** All types available on Credit Terms. Ready for plugging in to Amplifier or Tape Recorder.

**RP2** Consisting of Garrard SP25 Mk. II with heavy cast turntable and fitted Goldring CS90 high compliance ceramic Stereo/Mono cartridge with diamond stylus, plinth and cover. Normally approx. £26. Carr. 15/- ONLY **22 Gns.**

**RP3** As above but with Goldring Lenco GL68 Transcription unit and CS90 Cartridge. Normally approx. £22 gns. Carr. 15/- ONLY **27½ Gns.**

**RP3M** with Pickering Magnetic Cartridge. Normally approx. 40 gns. **35½ Gns.**



### AUDIOTRINE PLINTHS

for Record Playing units. Teak finish. Cut for Garrard. 1,000, 2,000, 3,000 AT60, SP25 or Goldring GL68. Available with clear Perspex cover as illustrated. £5/19/11 complete. Carr. 8/6 or slightly deeper type cut for TA12 but Perspex cover sold separately at 3 gns. Limited number, slightly damaged but repaired by manufacturer. 39/9 to clear.

66/-

## TA6 6-7 WATT HIGH FIDELITY AMPLIFIER

Solid State Circuitry  
Employing latest type Transistors. 200-250 v. A.C. mains operated.

Frequency Response 30-20,000 c.p.s. —2 dB Harmonic Distortion 0.3% at 1,000 c.p.s. Separate Bass and Treble "Hi" and "cut" controls. 3 input sockets for Mike, Gram, Radio or Tape Input Selector Switch. Output 3-15 ohm speakers. Max. Sensitivity 5mV. Fully enclosed enamelled case, 9½ x 2½ x 5½in. Attractive brushed silver finish facia plate 10½ x 9½in. and matching knobs. Complete kit of parts with full wiring diagrams and instructions. Or factory built with 12 mths. guar. Post paid 8 gns. Carr. 7/6. **6 Gns.**

### HI-FI LOUDSPEAKER ENCLOSURES

All types of pleasing modern design, acoustically lined and ported. Finished in Satin Teak Veneer.

**JES.** Size 20 x 11 x 5in. Gives pleasing results with any 8in. Hi-Fi Speaker. **4 Gns.**

**SEB.** For optimum performance with any Hi-Fi 8in. speaker. Size 22 x 15 x 9in. **5 Gns.**

**SEL0.** For 10in. Hi-Fi Speaker. Size 24 x 15 x 10in. **6 Gns.**

**SEL2.** For outstanding performance with any 12in. Hi-Fi speaker. Cut for tweeter. Size 25 x 16 x 10½in. **7 Gns.**

**ALL LEADING MAKES HI-FI EQUIPMENT IN STOCK**  
**INTEREST CHARGES REFUNDED**  
on H.P. and Credit Sale Accounts settled in 3 months.

## R-S-C-TA12 13 WATT STEREO AMPLIFIER

FULLY TRANSISTORISED, SOLID STATE CONSTRUCTION, HIGH FIDELITY OUTPUT OF 6.5 WATTS PER CHANNEL. Designed for optimum performance with any crystal or ceramic Gram. P.T. cartridge. Radio, Tuner, Tape Recorder, "Mike," etc. 3 separate switched input sockets on each channel. ★ Separate Bass and Treble controls. ★ Slide Switch for mono use. ★ Speaker Output 3-15 ohms. ★ For 200-250 v. A.C. mains. Frequency Response 30-20,000 c.p.s. ★ 2 dB. ★ Harmonic Distortion 0.3% at 1,000 c.p.s. Hum and Noise —70 dB. ★ Sensitivity (1) 300 mV (2) 100mV (4) 2mV. ★ Handsome brushed silver finish facia and knobs. Complete kit of parts with full wiring diagrams and instructions.



1,000 c.p.s. Hum and Noise —70 dB. ★ Sensitivity (1) 300 mV (2) 100mV (4) 2mV. ★ Handsome brushed silver finish facia and knobs. Complete kit of parts with full wiring diagrams and instructions.

**11 Gns.** Carr. 7/9. Factory built with 12 months guarantee. **15 Gns.** Carr. 7/9. Or Deposit £4/16/- and 9 monthly payments 29/- (Total £17 gns.) Teak finished cabinet as illustrated £3/13/6 extra. Or larger size as used in Stereo System 4 Gns.

### R.S.C. HIGH FIDELITY SPEAKER SYSTEMS

**FRIa** Consisting of high quality 12in. 12,000 line Bass Speaker cross-over unit and Tweeter. Smooth response and extended frequency range ensure surprisingly realistic reproduction. Impedance 15 ohms. Rating 5 Gns. Carr. 10 wats. Response 40-20,000 c.p.s. **6 Gns. 6/6**

**FR1b** Inc. HF126 Bass Speaker cross-over and Tweeter. Rating 15 wats. Recommended Cabinet type SEL2. **6 Gns.** 6/6

**FR2 10** Inc. powerful 10in. 15 watt HF105 Bass Speaker with roll rubber surround and 15,000 line ceramic magnet, plus choke/capacitor cross-over and highly efficient cone type Tweeter. Response 30-20,000 c.p.s. substantially flat throughout the audible range. Impedance 8-15 ohms. 7 Gns. Carr. (Recommended cabinet SEL10. Really excellent value at **7 Gns.** 6/6

**FR3b** 3 speaker System consisting of HF126 12in. 20 watt Bass speaker with roll rubber cone surround to obtain extremely low fundamental resonance, 5 in 10,000 line middle range speaker, high flux cone type tweeter, and appropriate choke/capacitor cross-overs. Impedance 15 ohms. Frequency response 20-20,000 c.p.s. Will provide sound quality to satisfy the most discriminating listener. Circuit and recommended cabinet size supplied. Only **11 Gns.**

## HIGH FIDELITY LOUDSPEAKER UNITS

Cabinets of latest styling Satin Teak or Walnut, acoustically lined (and ported where appropriate). Credit Terms available.

**DORSET** Size 16 x 11 x 9in. Response 45-18,000 c.p.s. Rating 5-10 wats. Fitted Audioutine HF810D speaker. 3 or 15 ohms. **£8.19.9**

**DORCHESTER** Size 24 x 15 x 10in. Fitted Audioutine HF101D Speaker. Rating 15 wats. **12½ Gns.**

**GLOUCESTER** Size 25 x 16 x 10in. 12in. High flux. 12,000 line speaker. Cross-over unit and Tweeter. Rating 10 wats. Smooth response 40-20,000 c.p.s. Impedance 15 ohms. Outstanding value. **12½ Gns.**

**STANTON** Mk. 111S. Size 18 x 11 x 10in. Rating 10 wats. Incorporating Audioutine HF815 Speaker with rolled rubber surround and 15,000 line magnet. Handsome Scandinavian design pressed cabinet. Response 30-20,000 c.p.s. Impedance 3 or 15 ohms. The deep excursions of the cone produce powerful bass notes, High Flux tweeter extends frequency range above audibility. Excellent transient response ensures smooth realistic output. **16 Gns.**

### R.S.C. A11 15 WATT HIGH FIDELITY AMPLIFIER

DUAL PURPOSE P.A. or HI-FI SOLID STATE CIRCUITRY

★ 3 input sockets. ★ 2 vol. controls, for mixing purposes. ★ Input Selector. ★ Output for speakers between 3 and 15 ohms. ★ Separate Bass and Treble controls. Suitable for Gram., Radio, Tape, Microphone, or Guitar P.U. For Vocal and Instrumental groups. Frequency response 20-40,000 c.p.s. —3 dB. Hum Level —80dB. Harmonic Distortion 0.2% at 10 wats R.M.S. Operation on 200-250 v. A.C. mains. Size 9½ x 2½ x 5½in. Complete Kit of parts with comprehensive wiring diagrams and instructions. **9 Gns.** Carr. 9/6.

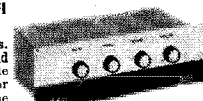

Or Factory built with 12 mths. guarantee. 13 gns. Carr. 9/6. Terms: Deposit £4 and 9 monthly payments 25/6 (Total £15/9/6).

### LINEAR LP/I TAPE PRE-AMPLIFIER

Switched Equalisation. Positions for recording at 1½in., 3½in., 7½in. per sec. and Playback. EM84 Recording Level Indicator. Designed primarily as the link between a Magnavox Tape Deck and Hi-Fi amplifier suitable most Tape Decks. Terms **10½ Gns.**

### TWO-WAY TELEPHONE AMPLIFIERS

Speak and listen with both hands free. Compact, solid state. Standard battery operation. Excellent value at **59/9**

### R.S.C. STEREO/20 HIGH FIDELITY AMPLIFIER

PROVIDING 10/14 WATT ULTRA LINEAR PUSH-PULL OUTPUT ON EACH CHANNEL SUITABLE FOR "MIKE", GRAM., RADIO OR TAPE. 7 valves ECC83 (2), ECC86 (4), E2Z1. Frequency Response: ± 2 dB 30-20,000 c.p.s. Hum level 65 dB down. Sensitivity: 20 millivolts max. Harmonic Distortion (each channel): 0.2%. Four-position tone compensation and Input Selector Switch. ★ Stereo/Mono switch. ★ Neon panel indicator. ★ Handsome Perspex Frontplate. ★ Separate Bass and Treble controls. Output transformer. High-quality sectionally wound. Outputs for 3 and 15 ohm speakers. Complete kit with **14 Gns.** Point-to-point wiring diagrams Carr. 12/6. Or factory assembled with our usual 12 months guarantee. 19 Gns. Carr. 12/6. Or send Dep. £4/10/- and 9 mthly. pmts. of £2 (Total £22/10/-). Send S.A.E. for leaflet

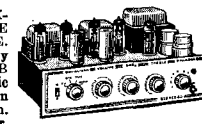

Or factory assembled with our usual 12 months guarantee. 19 Gns. Carr. 12/6. Or send Dep. £4/10/- and 9 mthly. pmts. of £2 (Total £22/10/-). Send S.A.E. for leaflet

### R.S.C. TFM1 TRANSISTORISED VHF/FM RADIO TUNER

Total cost of parts with detailed wiring diagrams and instructions. **12½ Gns.** Carr. 10/-.

★ High Sensitivity. ★ 200-250 v. A.C. Mains operation ★ Sharp A.M. Rejection. ★ Drift free reception. ★ Output ample for any amplifier (approx. 500 mV). ★ Simple alignment instructions. ★ Output available for feeding tuning meter. ★ Output for feeding Stereo Multiplexer. ★ Tuner head using Silicon Planar Transistors. ★ Designed for standard 80 ohm co-axial input. Visually matching our Super 15 and 30 amplifiers and of the same high standard of performance reliability. The pre-wired tuning head facilitates speed and simplicity of construction. Printed circuitry. Only first grade components used. A quality product at half the cost of comparable units. **STEREO VERSION available. All parts 18 Gns. Assembled 22½ Gns. In cabinet 25 Gns. Carr. 10/-.**

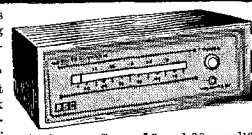

### R.S.C. SUPER 15 HI-FI AMPLIFIER

FULLY TRANSISTORISED 200/250 v. A.C. Mains. OUTPUT 10 WATTS R.M.S. cont. into 15 ohms. 15 WATTS R.M.S. into 3-4 ohms. LATEST MULLARD TRANSISTORS. AD149, AD149, OC127Z, OC81Z, OC44, OC44, OC81Z, OC44, AC107. 5 POSITION INPUT SELECTOR SWITCH EQUALISATION to Standard R.I.A.A. and C.C.I.R. Characteristics for Gram and Tape Heads. FULL TAPE MONITORING FACILITIES SENSITIVITIES: Magnetic P.U. 4mV. Crystal or Ceramic P.U. 400 mV. Microphone 4.5 mV. Tape Head 2.5 mV. Radio/Aux. or Ceramic P.U. 110 mV. FREQUENCY RESPONSE: ±2 dB 20-20,000 c.p.s. TREBLE CONTROL: +15 dB to -14 dB at 10 Kc/s. NEG. FEEDBACK: 62 dB. BASS CONTROL: +17 dB to -15 dB at 50c/s. HUM LEVEL: -75 dB. HARMONIC DISTORTION at 10 wats R.M.S. 1,000 c.p.s. 0.1%. Carr. 12/6. Complete Kit of parts with full constructional details and point to point wiring diagrams. Supplied factory built 15½ Gns. **11½ Gns.** Carr. 12/6. Terms: Deposit 4 Gns. and 9 monthly payments 31/1 (Total £18/3/9). Or fitted in beautiful walnut or teak veneered cabinet as illustrated. 3½ Gns. extra.

### R.S.C. SUPER 30 STEREO AMPLIFIER

A DUAL CHANNEL VERSION OF THE SUPER 15. Employing Twin Printed Circuitry. Close tolerance Ganged Pots Matched Components. CROSS TALK: —92 dB at 1,000 c.p.s. CONTROLS: 5 position Input Selector, Bass Control, Treble Control, Volume Control, Balance Control, Stereo/Mono Switch, Tape Monitor Switch, Mains Switch. INPUT SOCKETS (Matched Pairs). (1) Magnetic P.U. (2) Ceramic or Crystal P.U. (3) Radio/Aux. (4) Tape Head/Microphone. Operation of the Input Selector Switch assures appropriate equalisation. Rigid 18 s.w.g. Chassis. Size approx. 12 x 3 x 8in. Neon Panel Indicator. Attractive Facia Plate and Spun Silver Matching Knobs. Above facilities, except for Ganging and Balance Control, apply also to Super 15. SUPER SOUND OUTPUT CAN BE OBTAINED BY USING THESE UNITS WITH FIRST RATE ANCILLARY EQUIPMENT. All required parts, point to point, wiring diagrams and detailed instructions. Send S.A.E. for leaflet. **19 Gns.** Carr. 15/-.

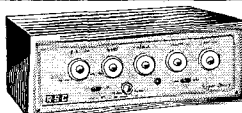

Unit factory built with 12 months full guarantee 27 gns. Or deposit 66/2- and 9 monthly payments 56/3 (Total £31/8/3). Fitted cabinet as Super 15, 30 Gns. Carr. 15/- or Deposit 28/2/6 and 9 monthly payments 64/- (Total £34/18/6).

**BRADFORD** 10 North Parade (Half-day Wed.) Tel. 25349  
**BRISTOL** 14 Lower Castle St. (Half-day Wed.) Tel. 22904  
**BIRMINGHAM** 30/31 Gt. Western Arcade opp. Snow Hill Station 021-236-1279. No Half-day.  
**DERBY** 26 Osmaston Rd., The Spot (Half-day Wed.) Tel. 41361  
**DARLINGTON** 18 Priestgate (Half-day Wed.) Tel. 68043.  
**EDINBURGH** 133 Leith Street (Half-day Wed.) Tel. Waverley 5766  
**GLASGOW** 326 Argyle St (No Half-day) Tel. CITY 4158 403 Sauchiehall St. (opp. Locharno) Tel. 332-1572  
**HULL** 91 Paragon Street (Half-day Thursday) Tel. 20505

**R.S.C. HI-FI CENTRES LTD.**

**MAIL ORDERS TO: 102-106 Henconner Lane, Bramley, Leeds, 13. No C.O.D. under £1. Terms C.W.O. or C.O.D. Postage 4/6 extra under £2, 5/9 extra under £5. Trade supplied S.A.E. with enquiries please.**

**HI-FI CATALOGUE 4/6 with coloured supplements**  
Open all day Saturdays except High Holborn Branch.

5-7 County Street (Half-day Thurs.) Tel. 56420  
**LEICESTER**  
 52 High Street (Mecca) Arcade Broughton (No Half-day) Tel. 28252  
**LEEDS**  
 73 Dale St. (No Half-day) Tel. CENTRAL 3573  
**LIVERPOOL**  
 238 Edgware Rd., W2 (Half-day Thurs.) Tel. PAD 1629  
**LONDON**  
 96 High Holborn, W.C.1. Tel. HOL 9874 (Half-day Sat.)  
 60A-60B Oldham St. (No Half-day) Tel. CENTRAL 2778  
**MANCHESTER**  
 106 Newport Rd (Half-day Wed) Tel. 47096  
**MIDDLESBROUGH**  
 41 Blackett St., opp. Fenwicks Store  
**NEWCASTLE UPON TYNE**  
 (Half-day Wed.) Tel. 21469  
 13 Exchange Street, Castle Market Bldgs.,  
**SHEFFIELD**  
 (Half-day Thurs.) Tel. 20716.

### HI-FI TAPE RECORDER KIT

Consisting of Magnavox 3 speed Tape Deck, Matched 4-5 watt Tape Amplifier. Reel of high quality recording Tape, empty 7 in. spool High quality dynamic microphone. 7 x 3 in. Loudspeaker and circuit. Full record and playback facilities. Magic eye level indicator. Equalization for each speed. Twin track. Only 4 pairs of soldered joints plus mains. Save approx. 10 Gns. on package deal. Carr. 17/6  
**24 1/2 Gns.**  
4 track version, 27 Gns.

### R.S.C. COLUMN SPEAKERS

Covered in two-tone Resine/Vynair ideal for vocalists and Public Address. 15 ohm matching.  
Type C48. 25-30 WATTS. Fitted four 8 in. high flux 7 watt speakers. Overall size approx. **15 Gns.**  
42 x 10 x 5 in. Or Deposit 44/- and 9 monthly payments 34/9.

### 12 in. HIGH QUALITY LOUDSPEAKERS

In teak veneered cabinets. 10 Watt Model. Gauss 12,000 lines. 2 or 15 ohms. **5 Gns.**  
20 Watt Model. 15 ohm. Size 18 x 18 x 10 in. Gauss 12,000 lines. Resine covered 10/- extra. **8 Gns.** Terms available.

### LOUDSPEAKERS Limited number at fraction of list price. 15 ohms impedance. Brand new, guaranteed. Terms available.

12 in. 20 WATT DUAL CONE **£5.15.0**

12 in. 30 WATT DUAL CONE Normally £13 approx. **£6.19.9**

### R.S.C. A10 30 WATT HIGH FIDELITY AMPLIFIER

Highly sensitive. Push-Pull high output with Pre-amp/Tone Control stages. Performance figures equal to most expensive amplifiers available. Frequency response ±3 dB 30-20,000 c/s. Sectionally wound ultra linear output transformer with 807 output valves. All first grade components. Valves, EF86, EF86, ECC83, 807, 807, CZ34. Separate Bass and Treble Controls. Sensitivity 12 millivolts so that any kind of microphone or pickup is suitable. Designed for Clubs, Schools, Theatres, Dance Halls or Outdoor Functions etc. For use with Electronic Organ, Guitar, String Bass, etc., Gram., Radio or Tape. Two inputs with associated volume controls. 200-250 v. 50 c/s. A.C. mains. For 3 and 15 ohm speakers. Complete kit of parts with point-to-point wiring diagrams and instructions. Carr. 12/6  
Supplied factory built with EL84 output valves. 12 months guarantee for 15 gns. Terms: Deposit 24/13/- and 9 monthly payments of 28/9 (Total £17/11/9). Twin-handled perforated cover can be supplied for 25/- . Send s.a.e. for leaflet.

### R.S.C. GRAM AMPLIFIER KIT 4 watts output.

Negative feedback. Controls: Vol., Tone and Switch. Mains operation 200-250 v. A.C. Fully isolated chassis. **49/11** Circuit, etc. supplied. Only

### R.S.C. BATTERY/MAINS CONVERSION UNITS

Type BML. An all dry battery eliminator. Size 5 1/2 x 4 1/2 x 2 in. approx. Completely replaces batteries supplying L.T. and 100 v. where A.C. mains 200/250 v. 50 c/s is available. Complete kit with diagram **47/9** or ready for use **59/11**.

### POWER PACK KIT

Consisting of Mains transformer. Metal Rectifier. Electrolytics, smoothing choke, chassis and circuit. 200/250 v. A.C. mains. Output 250 v. **22/11**  
50 mA 4.3 v. 250. Supplied with case in lieu of chassis, **26/11**. Or assembled **39/11**.

### SELENIUM RECTIFIERS F.W. (Bridged)

All 6/12 v. D.C. output Max. A.C. input 18 v. Ia. **3/11**. 2a. **6/11**. 3a. **9/9**. 4a. **12/8**. 6a. **15/8**. 10a. **25/9**.

### R.S.C. MAINS TRANSFORMERS

FULLY GUARANTEED. Interleaved and Impregnated. Primarys 200-250 v. 50 c/s. Screened.

MIDGET CLAMPED TYPE 2 1/2 x 2 1/2 x 2 1/2 in.	
250v. 60mA. 6.3v. 2a.	14/11
250-0-250v. 40mA. 6.3v. 2a.	15/11

### FULLY SHROUDED UPRIGHT MOUNTING

250-0-250v. 60mA. 6.3v. 2a. 0-5-6.3v. 2a.	19/9
250-0-250v. 100mA. 6.3v. 4a. 0-5-6.3v. 3a.	33/9
350-0-350 v. 100mA. 6.3v. 4a. 0-5-6.3v. 3a.	33/9
300-0-300v. 130mA. 6.3v. 4a. c.t. 6.3v. 1a. For Mullard 510 Amplifier.	41/9

### TOP SHROUDED DROP-THROUGH TYPE

250-0-250v. 70mA. 6.3v. 2a. 0-5-6.3v. 2a.	19/9
250-0-250v. 100mA. 6.3v. 3a.	21/9
250-0-250v. 100mA. 6.3v. 2a. 6.3v. 1a.	22/9
350-0-350v. 80mA. 6.3v. 2a. 0-5-6.3v. 2a.	23/9
250-0-250v. 100mA. 6.3v. 4a. 0-5-6.3v. 3a.	32/9
300-0-300v. 100mA. 6.3v. 4a. 0-5-6.3v. 3a.	32/9
300-0-300v. 130mA. 6.3v. 4a. 0-5-6.3v. 1a. Suitable for Mullard 510 amplifier.	39/9

### PILAMENT or TRANSFORMER POWER PACK TYPES

0.3v. 1.5a. <b>6/9</b> . 6.3v. 2a. <b>7/9</b> . 6.3v. 3a. <b>9/9</b> . 6.3v. 6a. <b>19/9</b> . 12v. 1a. <b>8/9</b> . 12v. 3a. or 24v. 1.5a. <b>19/9</b> . 0-9-18v. 11a. <b>15/8</b> . 0-12-25-42v. 2a. <b>27/9</b> .
--

### CHARGE TRANSFORMERS 0.9-15v. 11a. 13/11. 21a. 16/11. 3a. 18/11. 5a. 21/11. 6a. 25/11. 8a. 31/11.

### AUTO (STEP UP) TRANSFORMERS

0-110 (Step UP) 200-250-250v. 30-80watts	14/9
150 watts. 29/11. 250 watts. 49/9. 500 watts	99/9

### OUTPUT TRANSFORMERS

Standard Pentode 5,000Ω or 7,000Ω to 3Ω	7/9
Push-Pull 5 watts EL84 to 3Ω or 15Ω	11/9
Push-Pull 10 watts 6V6 ECC85 to 3, 5, 8 or 15Ω	21/9
Push-Pull EL84 to 3 or 15Ω 10-12 watts	19/9
Push-Pull Ultra Linear for Mullard 510. etc.	35/9
Push-Pull 15-18 watts, sectionally wound 6L6, KT66, etc. for 3 or 15Ω	29/9

### PUSH-PULL 20 watt high quality sectionally wound. EL84, 6L6, KT66, etc. to 3 or 15Ω fully shrouded.

150mA. 7-10H. 250Ω	12/9
100mA. 10H. 200Ω	9/11
80mA. 10H. 350Ω	7/9
60mA. 10H. 400Ω	4/11

**R.S.C.**  
HI-FI CENTRES LTD.

WW—119 FOR FURTHER DETAILS

Circuits & Diagrams plus full repair data for

# 800 POPULAR MODELS

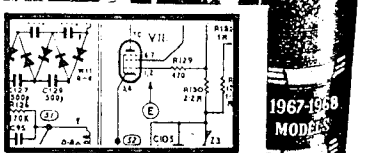

Circuit diagrams

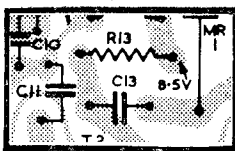

Printed panel diagrams

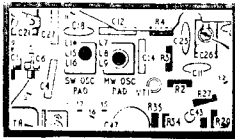

Component layout diagrams

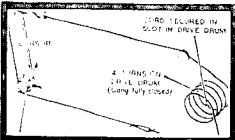

Drive-cord diagrams

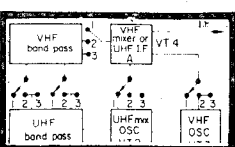

Block diagrams

IT'S SENT TO YOUR HOME CARRIAGE-PAID TO EXAMINE ON 7 DAYS'

## FREE TRIAL

## RADIO & TV SERVICING

Big 3 Volume time-saving repair library to step up your earnings

Here is a great new edition of RADIO & TV SERVICING, to save your time, to boost your earning power. Packed with CIRCUITS, REPAIR DATA and vital information it covers all the popular 1965-1968 TVs, Radios, Grams, Record Players and Tape Recorders—including latest data on COLOUR TV. Thousands of sets of previous editions sold. Now you can examine this big NEW edition free for a week. Three handsome volumes—over 1,500 pages written by a team of research engineers—there's no other publication like it. Speeds up repair work for year after year. Hurry—send no money—simply post coupon today... There can be no reprint once stocks are sold and there's absolutely no obligation to buy under this free trial offer.

## Full Data and Circuits for repair of Televisions including COLOUR TV

- Radios • Radiograms • Car Radios
- Record Players • Tape Recorders

## SERVICING DATA FOR ALL THESE MAKES

Aiwa, Alba, Baird (including colour TV), Beogram, Beolit, Bush, Carousel, Cossor, Dansette, Decca, Defiant, Dynaport, Dynatron, Eddystone, Ekco, Elizabethan, Ever Ready, Ferguson, Ferranti, Fidelity, G.E.C. (including colour TV), Grundig, H.M.V., Kolster-Brandes, Hitachi, Invicta, McMichael, Marconiphone, Masteradio, Motorola, Murphy, National, Newmatic, Pam, Perdio, Peco-Scott, Philips (including colour TV), Portadyne, Pye, Radiomobile, R.G.D., Regentone, Roberts' Radio, Sanyo, Sharp, Smith's Radiomobile, Sobell (including colour TV), S.T.C., Sony, Standard, Stella, Stereound, Teletron, Thorn, Trans Arena, Ultra, Van Der Molen, World Radio.

## PLUS latest developments in Radio and Television

Including—Integrated Tuners, Stereo Multiplex Broadcasting—The Zenith—G.E System, Receiver, Decoder and adjustments, Aerial, etc. Colour TV Receivers. Colour TV Test Card F, Servicing Transistor Equipment, Chemical Aids to Servicing Batteries and Rechargeable Cells, Sound-on-Sync., Double Line Sync., Silicon Transistors, etc.

Over 1,500 pages, nearly 1,700 circuits, component layout diagrams, printed panel diagrams, tables and wave form graphs. Handsome binding.

**POST COUPON TODAY—absolutely no obligation to buy.**

To: Buckingham Press Ltd., 18-19 Warren Street, London, W.1. Please send RADIO & TV SERVICING—3 Volumes, without obligation to buy if you accept my application. I will return the books in 8 days or post—

Tick (✓)  Full cash price of £12, or here  15/- dep. and 16 monthly payments of 15/-.

If you are under 21 your father must fill in coupon.

Full Name.....  
(Block Letters)  
Address.....  
County.....  
Occupation.....  
Signature.....  
(Credit Price £12/15/-)

Please tick (✓) here  
The address on left is  
My/your property  
Rented  
Unfurnished  
Furnished accom.  
Temporary address  
If none of the above please answer here

Mr.  
Mrs.  
Miss

RV3/3675

# Wilkinsons FOR RELAYS

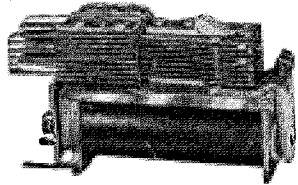

**P.O. TYPE 3000 AND 600**  
**BUILT TO YOUR REQUIREMENTS—QUICK DELIVERY**  
**COMPETITIVE PRICES—VARIOUS CONTACTS**  
**DUST COVERS—QUOTATIONS BY RETURN**

**LARGE STOCKS OF MINIATURE SEALED RELAYS, DETAILED LIST ON REQUEST**

**LEDEX SOLENOID DRIVEN WAFER SWITCHES.** SIZE 5S. From 90/-, 11 Way and off, 3 to 24 Pole; also 4 Pole 12 Way and 54 Pole on/off. Commutating switch section and control wafers available.

**PRESSURE TRANSDUCERS** SE152A 20 P.S.I. with Transformer £15.

**LINEAR TRANSDUCERS** IT-1-4F, \$3.

**PRESSURE VALVES** 300 p.s.i. Dunlop AC60414, \$5 ea., 3,500 p.s.i. Dunlop ACM20186, \$10 ea.

**HAIR HYGROMETER.** 4in. round by Negretti & Zambra, sealed 0/100 r.p.h., 65/-, post 3/-.

**MICRO SWITCH.** Burgess MK4BR, robust die cast casing, 8/6 each. Post 9d.

**MINIATURE BUZZERS.** 12 volt with tone adjuster, 7/6.

**STROBOSCOPE FORK.** 125 cycles. P.O. No. 5, 30/- ea.

**EQUIPMENT WIRE** 1/024 and 7/0076 PVC covered in various colours, 80/- per 1,000 yards. Post 6/-.

**KEY SWITCHES** (3 position)  
 4 C Non Lock/4 C Non Lock, 16/6.  
 4 C Non Lock/6 C Lock, 20/-.  
 2 C Lock 2 C Lock, 12/6.  
 4 C Lock/4 C Lock, 17/6.  
 Stop/4 C Lock, 12/6.  
 Stop/8 C Lock, 17/6.  
 8 Change over Muirhead, 17/6.  
 Stop 2/C Lock, 7/6. One hole fixing.  
 Stop 4/C Non Lock, 10/6. One hole fixing.  
 2 C Lock/6 C Lock, 17/6. One hole fixing.

**RECTIFIER UNIT A.C. to D.C.** Input 200/250 v. A.C. Output 6 v. D.C. at 15 amps, full regulation. Meter, Fuses, Westinghouse, \$8/10/-. Carr. 20/-.

**BLOWER MOTORS.** 200/250 volt Capacitor Type 2,800 r.p.m. Cylindrical casing 7in. X 7in. X 7in. with open flange each end, \$10. Larger size \$14. Carr. 10/6.

**ROOM THERMOSTAT.** Adjustable between 45 and 75 deg. Fahr., 250 v. 10 amp. A.C. Ideal for green-houses, etc., 35/- Post 2/6.



TRANSISTORS		DIODES		SCR'S		ZENNERS		VALVES	
ASZ20	7/-	2N698	5/-	SX68	4/6	OA10	3/-		
GET875	5/6	BZY88	3/-	SX645	15/-	OA91	2/6		
OC44	3/6	2N1997	5/-	SX641	3/-	OA2242	4/6		
OC45	3/-	2N1305	3/-	ZT42	10/-	VR525A-B6	1/-		
OC71	3/-	2N1613	4/-	ZT83	11/6	ECC81	4/-		
OC200	7/-	2N1596	29/-	IS31	1/-	E88C	12/-		
2S002	15/-	V30-3P	15/-	DDO06	6/-	12BH7	7/6		

## SMALL MAGNETIC COUNTERS

3½ x 1in., 10 counts per second with 4 figures. The following D.C. voltages are available, 6 v., 12 v., 24 v., 50 v. or 100 v.

**COUNTING INSTS** make 48 volts D.C. 6 digits with ZERO RESET, 70/- ea., post 3/-.

**DIGITAL INDICATOR** KGM M5, 28 volt 0 to 9, each, 50/-.

**TERMINAL STRIPS.** Double ended tags on ceramic insulating pieces mounted on metal U channel ½in. wide 2 to 24 way, 3d. per way.

**RELAYS.** 24 volt D.C. 4 make 4 break heavy duty with dust cover. 5C/3944, 12/6 each, post 1/-.

**JACK PLUGS.** 2 Point, with screw-on cover, 2/6, post 9d.

**PO 201** with cord, 3/-, post 1/6.

**PLUG-IN RELAYS.** Londec 4 change-over HD contacts 28 v. D.C. or 240 v. A.C. with base and cover, 35/- each.

**RATIO ARM UNITS.** Sullivan 600 Ω : 600Ω. 50/-.

**RESISTORS,** wire wound or carbon, potentiometers, condensers, quantities ex-stock at low prices.

## METERS GUARANTEED. Complete list available

Microamps	0/100	2½in. MC	40/-
Microamps	0/500	2in. M.C.	25/-
Microamps	0/500	2½in. MC	37/6
Milliamps	0/50	2½in. MC	35/-
Milliamps	0/500	3½in. MC	54/-
Amps	0/5	2in. MC	37/6
Volts	5/0/5	2½in. MC	25/-
Volts	0/20	2in. MC	37/6
Volts	0/5 A.C.	3½in. M.C.	55/-
Volts	0/10 A.C.	3½in. MCR	70/-

Microamps 0/50 scaled in Milli Rontgens 2½in. MC 45/-  
 Millivolts 350/0/350 (3.5/0/3.5) Millia 2½in. MC 35/-

**PORTABLE VOLTMETERS,** 0/250 Moving Iron A.C./D.C. 6in. scale, in polished wood case, \$7/10/-.

**ONE HOLE FIXING SWITCHES**  
**SINGLE POLE** Double Throw, 3 amp, 250 v. A.C., can be used as ON/OFF or CHANGE-OVER switch.  
 18/- per dozen, 130/- per 100.  
 post 2/- post 5/-

**AVO 7.** Power factor and wattage unit, \$7, post 6/-.

**"VISCONOL-CATHODRAY" CONDENSERS** .001 mfd. 10 kv, 5/-; .002 mf 15 kv, 9/-; .02 mf, 10 kv, 10/-; .025mf 2.5 kv, 5/-; .05 mf 5 kv, 9/-; 0.1 mf 4 kv, 9/-; 6 kv, 17/6; 0.5 mf. 2.5 kv, 17/6; 1 mfd 2 kv, 17/6.

**BLUE LINE.** Heavy Duty Switches by Kraus & Naimier Code AAL213 with extras, also C16 Switches available from stock at less than maker's price.

**BRIDGE MEGGER SERIES 1.** With resistance box and leads 1,000 v., 0-100 megohms. Usual price £189. Our price £75.

**GEARED MOTORS,** 3 r.p.m. or 1 r.p.m. 4 watts, very powerful, reversible 24 v. A.C., 35/-, post 2/6. Operated from 230 v. with our Transformer, 20/-.

**MIRROR GALVANOMETERS** BB 3000. N.E.P. Focal length 20 cm., \$18.

**L. WILKINSON (CROYDON) LTD.**  
 LONGLEY HOUSE LONGLEY RD. CROYDON SURREY  
 Phone: THO 0236 Grams: WILCO CROYDON

## LATEST RELEASE OF

## RCA COMMUNICATION RECEIVERS AR88

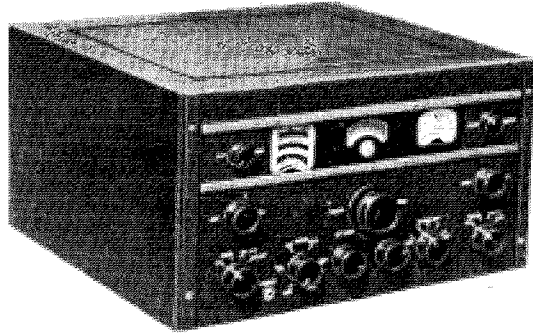

**BRAND NEW** and in original cases—A.C. mains input. 110V or 250V. Freq. in 6 bands 535 Kc/s-32 Mc/s. Output impedance 2.5-600 ohms. Complete with crystal filter, noise limiter, B.F.O., H.F. tone control, R.F. & A.F. variable controls. Price £87/10/- each, carr. £2.

Same model as above in secondhand cond. (guaranteed working order), from £45 to £60, carr. £2.

**SET OF VALVES:** new, £3/10/- a set, post 7/6; available with Receiver only. **SPEAKER:** new, £3 each, post 10/-.

**HEADPHONES:** new, £1/5/- a pair, 600 ohms impedance. Post 5/-.

**AR88 SPARES.** Antenna Coils L5 and 6 and L7 and 8. Oscillator coil L55. Price 10/- each, post 2/6. RF Coils 13 & 14; 17 & 18; 23 & 24; and 27 and 28. Price 12/6 each. 2/6 post. By-pass Capacitor K.98034-1, 3 x 0.05 mfd. and M.980344, 3 x 0.1 mfd., 3 for 10/-, post 2/6. Trimmers 95534-502, 2-20 p.f. Box of 3, 10/-, post 2/6. Block Condenser, 3 x 4 mfd., 600 v., £2 each, 4/- post.

S.A.E. for all enquiries. If wishing to call at Stores, please telephone for appointment.

**W. MILLS** 3-B TRULOCK ROAD, TOTTENHAM, N.17  
 Phone; Tottenham 9213

## ADVANCE TEST EQUIPMENT

**VM76: Valve Voltmeter:** R.F. measurements in excess of 100 MHz and D.C. measurements up to 1,000V with accuracy of ±2%. D.C. range -300mV-1kV f.s.d. A.C. range -300mV-300V r.m.s. Resistance in 8 ranges, 0.02-500 Megohms. OUR PRICE, only £72.

**VM78: A.C. Millivoltmeter:** Transistorised. 1mV-300V in 12 ranges. Freq. 1C/s-1Mc/s. Input impedance 2 Megohms 60 p.f. Calibrated in r.m.s. for sine wave and input dB. OUR PRICE, only £55.

**VM79: UHF Millivoltmeter:** Transistorised. A.C. range 10 mV-3V f.s.d. 10 ranges. D.C. current range 0.01µA-0.3mA f.s.d. 10 ranges. Resistance 1 Ohm-10 Megohms in 7 decade ranges. Complete with probe. OUR PRICE, only £125.

**H1B: Audio Signal Generator:** 15 c/s-50Kc/s in 3 ranges. Sine wave 200µV-20V r.m.s. Square wave 1.4mV-140V. peak to peak (approx.). 100-250V A.C. OUR PRICE, only £30.

**J1B: Audio Signal Generator:** 15c/s-50Kc/s in 3 ranges. Output 600 ohms, 0.1mW-1W (0.25-24V), variable. Attenuation 20dB-600 ohms (attenuator is incorporated), output 10mW (2.5V). 100-250V a.c. OUR PRICE, only £30.

**J2B: Audio Signal Generator:** Same specification as for the J1B except that this model has an additional 2in. meter calibrated 0-40V A.C. OUR PRICE, only £35.

**TT1S: Transistor Tester (CT472):** Suitable for measuring medium and low powered transistors. Current gain (B) can be measured in range 10 to 500 for p.n.p. and n.p.n. types, either in circuit using clip-on probes provided. OUR PRICE, only £37/10/-.

Special offer of 10% discount for schools and Technical Colleges etc. These goods were manufactured in U.K. by Advance Electronics, Ltd. BRAND NEW, all in original sealed carton. CARR. 10/- EXTRA PER ITEM.

**HRO RECEIVER, Model 5T.** This is a famous American High Frequency superhet, suitable for CW, and MCW, reception crystal filter, with phasing control. AVC and signal strength meter. Freq. range 50 kc/s. to 30 mc/s., with set of nine coils. Receiver only in working order, £18/10/-, carr. 15/- each. Set of nine coils, £12/10/-, available only with set. Power unit for HRO 100/240 v. A.C., £2/15/-, carr. 10/-.

**SPECIAL OFFER;** Complete HRO 5T SET (Receiver, Coils and Power Unit) for £30, plus 30/- carr.

**HRO-M-SETS** available with UX type valves; secondhand cond., with 5 coil and power unit, £20 each, carr. 30/-.

**COMMAND RECEIVERS;** Model 3-6 Mc/s. and 6-9 Mc/s., as new, price £5/10/- each, post 5/-.

**COMMAND TRANSMITTERS, BC-458:** 5.3-7 Mc/s., approx. 25W output, directly calibrated. Valves 2 x 1625 PA; 1 x 1626 osc.; 1 x 1629 Tuning Indicator; Crystal 6,200 Kc/s. New condition—£3/10/- each, 10/- post. (Conversion as per "Surplus Radio Conversion Manual, Vol. No. 2," by R. C. Evenson and O. R. Beach.)

**BC-433G COMPASS RECEIVER;** Freq. 200-1,750 Kc/s. in 3 bands, suitable for aircraft, boats, etc. Complete with 15 valves, power supply input 24 v. D.C. at 2 amps. Receiver only £5 each, carr. 15/-.

**ROTARY TRANSFORMERS:** 24 v. input, 175 v. at 40mA output, 25/-, plus 2/- post. 12 v. input, 225 v. at 100 mA output, 25/-, plus 3/- post (All the above are D.C. only).

**ROTARY CONVERTERS:** Type 8a, 24 v. D.C., 115 v. A.C. @ 1.8 amps. 400 c/s 3-phase, £6/10/- each, 8/- post. Converter 12 v. D.C. input, 110 v. A.C. 60 c/s output, £15 each, £1 carr.

**AVO MULTIRANGE No. 1 ELECTRONIC TEST SET:** £25 each, carr. £1.

**AVOMETERS:** Model 47A, £9/19/6 each, 10/- post. Model 7x, £13/10/- each, 10/- post. Excellent secondhand cond. (Meters only). (Batteries and Leads extra—at cost).

**OSCILLOSCOPE Type 13A,** 100/250 v. A.C. Time base 2 c/s.-750 Kc/s. Bandwidth up to 5 Mc/s. Calibration markers 100 Kc/s. and 1 Mc/s. Double Beam tube. Reliable general purpose scope, £22/10/- each, 30/- carr.

**COSSAR 1035 OSCILLOSCOPE,** £30 each, 30/- carr.

**RELAYS:** Relay Unit (with 9 American relays) 24 v. D.C., 250 ohm coils, heavy duty, M. & B. 30/- each, 4/- post. GPO Type 600, 10 relays @ 300 ohms with 2M and 10 relays @ 50 ohms with 1M., £2 each, 6/- post.

**CALIBRATION TACHOMETER Mk. II:** Maxwell Bridge Type 6C/869, £25 each, £2 carr.

**ROTAX VARIAC & METER UNIT:** Type 5G.3281. Reading 0-40 v., 0-40 mA and 0.5 amps., all on 275 deg. scales, £30 each, £2 carr.

**MARCONI IMPEDANCE BRIDGE, TF-373:** inductance 5µh-100H in 5 ranges capacity 5pF-100µF in 5 ranges, resistance .05 meg.-1 meg., power supply 250 v. A.C., £37/10/- each, carr. 15/-.

**HEWLETT PACKARD TYPE 400C:** 115 v./230 v. input 50/60 c/s. Freq. range 20 c/s-2 Mc/s. Voltage range: 1mV-300 v. in 12 ranges. Input impedance 10 megohms. Designed for rack mounting, £30 each, carr. 15/-.

**TCS MODULATION TRANSFORMERS,** 20 watts, pr. 6,000 C.T., sec. 6,000 ohms. Price 25/-, post 5/-.

**CONDENSERS.** 10 mfd. 1,000 v., 12/6, post 2/6. 8 mfd., 1,200 volts, 12/6, post 3/- . 8 mfd. 600 volts., 8/6 post 2/6. 0.25 mfd., 2 kv., 4/- post 1/6.

**AUTOMATIC PILOT UNIT Mk. 2.** This complex unit of diodes and valves, relays, magnetic clutches, motors and plug-in amplifiers, with many other items, price £7/10/-, £1 carriage.

**FOR EXPORT ONLY:** B.44 Transceiver Mk. III. Crystal control, 60-95 Mc/s. **AMERICAN EQUIPMENT:** 5C-640 Transmitter, 100-156 Mc/s., 50 watt output. For 110 or 230 v. operation. ARC 27 transceivers, 28 v. D.C. input. Also have associated equipment. BC-375 Transmitter, BC-778 Dinghy transmitter. SCR-522 transceiver. Power supply, PP893/GRC 32A; Filter D.C. Power Supply F-170/GRC 32A; Cabinet Electrical CY 1288/GRC 32A; Antenna Box Base and Cables CY 728/GRC; Mast Erection Kits, 1186/GRC; Directional Antenna CRD.6; Comparator Unit, CM.23; Directional Control CRD.6, 567/CRD and 568/CRD; Azimuth Control Units, 260/CRD. Test Set URM.44, complete with Signal Generator TS.622/U.

**VARIABLE POWER UNIT:** complete with Zenith variac 0-230 v., 9 amps.; 2 1/2 in. scale meter reading 0-250 v. Unit is mounted in 19 in. rack, £16/10/- each, 30/- carr.

**BC.640 MODULATOR UNIT:** approx. 50 w. output. Complete with modulation transformer; mike and drive transformer; filament transformer 230 v. A.C. Valves: two 811's. Unit mounted in 19 in. panel, £6/10/- each, £1 carr.

**SOLENOID UNIT:** 230 v. A.C. input, 4 pole, 15 amp contacts, £2/10/- each, post 6/-.

**CONTROL PANEL:** 230 v. A.C., 24 v. D.C. @ 2 amps., £2/10/- each, carr. 12/6.

**AUTO TRANSFORMER:** 230 v.-115 v.; 1,000 w., £2 each, carr. 12/6.

#### SIGNAL GENERATORS:

**MARCONI TF-144G:** freq. 85 Kc/s-25 Mc/s, internal and external modulation, power supplies 200/250 v. A.C. (secondhand cond), price £25 ea.; or available in transit case, complete with spares, in first class condition, £30 ea., carr. on both 30/- ea.

**TS155c/UP** (as new): price £75 each, carr. £1.

**CT53.** Freq. range 8.9-300 Mc/s. with Calibration chart. Output 1µV-100 mV. internal square wave and sinewave modulation at 100 c/s., external modulation 50 c/s-10 Kc/s., 230 v. A.C. Complete with chart, etc., price £27/10/- ea., carr. £1.

**MARCONI TF517-F/1:** Covering 10-18 Mc/s., 33-58 Mc/s., 150-300 Mc/s. £12/10/- each, carr. £1.

**MARCONI CT218:** price £65 each, carr. 30/-.

**CT.480 and 478:** 1.3-4.2 Mc/s., F.M. or A.M., price £75 each, carr. 30/-.

**POWER SUPPLY UNIT PN-12B:** 230 v. A.C. input, 395-0-395 v. output @ 300 mA. Complete with two x 9H chokes and 10 mfd. oil filled capacitors. Mounted in 19 in. panel, £6/10/- each, £1 carr.

**SCR-522 TRANSMITTER/RECEIVER:** This model is a VHF unit consisting of the BC-625 and the BC-624. These units are ideally suited for conversion to two meters. The set is automatically tuned; 4 channels; crystal controlled. The transmitter unit consists of 2 x 832's; 3 x 12A6's; and 1 x 6G6 together with modulation transformer. The Receiver consists of 3 x 9003's; 1 x 9002; 3 x 12SG7's; 1 x 12C8; 1 x 12J5; and 1 x 12AH7. £5 each, £1 carr. (Conversion as per "Surplus Radio Conversion Manual," Vols. 1 & 2, by R. C. Evenson and O. R. Beach.)

**TX DRIVER UNIT:** Freq. 100-156 Mc/s. Valves 3 x 3C24's; complete with filament transformer 230 v. A.C. Mounted in 19 in. panel, £4/10/- each, 15/- carr.

**POWER UNIT:** 110 v. or 230 v. input switched; 28 v. @ 45 amps. D.C. output. Wt. approx. 100 lbs., £17/10/- each, 30/- carr. **SMOOTHING UNITS** suitable for above £7/10/- each, 15/- carr.

**NIFE BATTERIES:** 6 v. 75 amps., new, in cases, £15 each, £1 carr.; 6 v. 160 amps., new in cases, £25 each, £1/10/- carr.; 4 v. 160 amps, new, in cases, £20 each, £1/10/- carr.

**L.R.7 Cells,** only 1.5 v. 75 amps., new, £3 each, 12/- carr. The above batteries are low resistance designed to give a heavy surge for starting and can be stored for long periods without any effect to their performance.

**FUEL INDICATOR Type 113R:** 24 v. complete with 2 magnetic counters 0-9999, with locking and reset controls mounted in a 3 in. diameter case. Price 30/- each, postage 5/-.

**UNISELECTORS** (ex equipment): 10 Bank 50 Way, alternate wipe, £2/5/- ea. 6 Bank, 25 Way, alternate wipe, £2/2/6 ea. 8 Bank, 25 Way, £2/5/- ea. 6 Bank, 25 Way, £2 ea. 4 Bank, 25 Way, 35/- ea. All the above are 75 ohm coil. Postage 4/- per uniselectors.

**FREQUENCY METERS:** LM13 or BC-221; 125-20,000 Kc/s., £25 each, carr. 15/- . TS.175/U, £75 each, carr. £1. TS323/UR; 20-450 Mc/s., £75 each, carr. 15/- . FR-67/U: This instrument is direct reading and the results are presented directly in digital form. Counting rate: 20-100,000 events per sec. Time Base Crystal Freq.: 100 Kc/s. per sec. Power supply: 115 v., 50/60 c/s., £100 each, carr. £1.

**CT.49 ABSORPTION AUDIO FREQUENCY METER:** freq. range 450 c/s-22 Kc/s., directly calibrated. Power supply 1.5 v.-22 v. D.C. £12/10/- each, carr. 15/-.

**CATHODE RAY TUBE UNIT:** With 3 in. tube, colour green, medium persistence complete with nu-metal screen, £3/10/- each, post 7/6.

**APNI ALTIMETER TRANS./REC.,** suitable for conversion 420 Mc/s., complete with all valves 28 v. D.C. Dynamotor and 3 relays, 11 valves, price £3 each, carr. 10/-.

**GEARED MOTORS:** 24 v. D.C., current 150 mA, output 1 r.p.m., 30/- each 4/- post. Assembly unit with Letcherbar Tuning Mechanism and potentiometer, 3 r.p.m., £2 each, 5/- post.

**MOTORISED ACTUATOR:** 115 v. A.C. 400 c/s. single phase, reversible, thrust approx. 3 inches complete with limit switches, etc. Price £2/10/- each, postage 5/- (ex equipment).

**Actuator Type SR-43:** 28 v. D.C. 2,000 r.p.m., output 26 watts, 5 inch screw thrust, reversible, torque approx. 25 lbs., rating intermittent, price £3 each, post 5/-.

**FRACTIONAL MOTORS & FANS:** Low inertia Motor 5UD/5361, Type 903, 24 v. input D.C., £2/10/- each, 5/- post.

**Model PM84:** 28 v. D.C. @ 2 amps., 4,500 r.p.m., output 40 watts continuous duty complete with magnetic brake. Price £2 each, postage 4/-.

**Model SR-2:** 28 v. D.C. 7,000 r.p.m., duty intermittent, output 75 watts, price 25/- each, postage 4/- . A.C. Motor 115 v. 50 c/s. 1/300 H.P., 3,000 r.p.m. Capacitor 1mfd., 25/- post 3/- . Dalmotor SC5, 28 v. D.C. at 45 amps; 12,000 r.p.m. output 750 W. (approx. 1 h.p.), brand new, £2/10/- each, post 7/6.

**TELEPHONES (PORTABLE) TYPE "F."** Suitable for all outdoor activities up to a range of 5 miles. Price £7/10/- each, as new, complete with carrying case. Carr. 10/-.

**TELEPHONE WIRE;** 220 yds., £1 a roll, post 6/-.

**CALLERS BY TELEPHONE  
APPOINTMENT ONLY**

**W. MILLS**

**3-B TRULOCK ROAD, TOTTENHAM, N.17**

Phone: Tottenham 9213

# GALAN

## STABILISED POWER SUPPLY

Type C270 0-30 Volts 0-2A

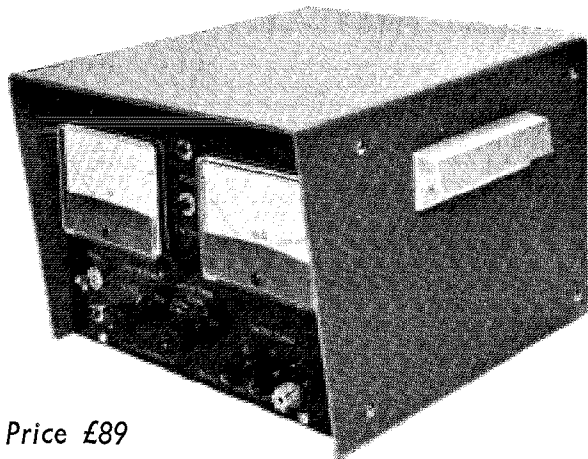

Price £89

Built to last.  
Full protection of instrument and load.  
Instant suppression of current following overload.  
Two voltage Ranges.  
Five current Ranges.  
Independent meeting of current and voltage.

**CALAN ELECTRONICS LTD**

6 CROFT ST, DALKEITH, SCOTLAND. Phone DALKEITH 2344

WW-125 FOR FURTHER DETAILS

**ILIFFE  
BOOKS**

## THE TAPE RECORDER

Second Edition

by C. G. NIJSEN

This book has been specially written in clear, simple non-technical language for the rapidly growing band of enthusiasts for whom the tape recorder is as indispensable as a radio, a record player or a camera. It shows how the best possible results can be obtained from a recorder, whether it is used for pleasure or education purposes.

In this second edition a chapter on cassette recorders has been added explaining the principles and the advantages of this system for the user who above all wants "simplicity of operation."

Because of its practical approach, this book, by an author with many years of experience in all branches of sound recording, will be easily understood even by those new to the subject, and will assist all those reading it to improve the standard of their recording.

172 pp., illustrated, 18s. net, 18s. 11d. by post.

obtainable from leading booksellers

**ILIFFE BOOKS LTD.**  
42, RUSSELL SQUARE, LONDON, W.C.1.

All overseas enquiries & orders please address to:  
**COLOMOR (ELECTRONICS) LTD.**  
170 Goldhawk Rd., London, W.12. Tel. (01) 743 0899

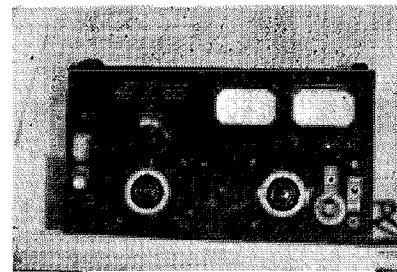

**BOONTON STANDARD SIGNAL GENERATOR MODEL 80.** Frequency 2-400 Mc/s. in 6 ranges. AM, 400 and 1,000 c/s. and external modulation. Provision for pulse modulation. Piston type attenuator 0.1μ-100 mV separate meter for modulation level and carrier level. Precision flywheel tuning. 117 v. A.C. input. With instruction manual, £95. Carriage 30/-.

**MARCONI SIGNAL GENERATOR TYPE TF 144G.** 85 kc/s.-25 Mc/s. Excellent laboratory tested condition, with all necessary accessories with instruction manual, £45. P. & P. 15/-.

**BC 221 FREQUENCY METERS.** 125-20,000 kc/s. Accuracy 0.01%. Complete with individual Calibration book. In brand new condition with headphones and instruction book. £45. P. & P. 20/-. Mains P.S.U. for above, £11/10/-. Carriage 5/-. Stabilised PSU for above £16 Carriage 5/-.

**MARCONI SIGNAL GENERATOR TF 801/A/1.** 10-300 Mc/s. in 4 bands. Internal at 400 c/s. 1 kc/s. External 50 c/s to 10 kc/s. Output 0-100 db below 200 mV from 75 ohms source. £85. P. & P. 20/-, including necessary connectors, plugs, and instruction manual.

**R.F. METERS.** 300 mA. 2in. clip fix. 19/-, 300 mA. 2½in. flush. 27/6.

**SIGNAL GENERATOR TYPE TS 418.** Signal frequency 400-1,000 Mc/s. direct calibration. Pulse rate 40-400 c (X1 or X10), pulse delay variable, less than 3μsec. to more than 300μsec. Pulse width variable less than 1μsec. to more than 10μsec. Polarity—internal or external sources, positive or negative pulses. AM & CW. Output attenuator 0.2μV to 200mV continuously variable. In fully tested condition, £150. Carriage paid.

**ENGLISH ELECTRIC INSULATION TESTER.** 10kV D.C. with built in ionisation amplifier. £35. P. & P. 15/-.  
Variable Condenser 200pF., 1,000 v. 12/6. P. & P. 5/-.

**PRECISION VHF FREQUENCY METER TYPE 183.** 20-300 Mc/s with accuracy 0.03% and 300-1,000 Mc/s with accuracy 0.3%. Additional band on harmonics 5.0-6.25 Mc/s with accuracy  $2 \times 10^{-4}$ . Incorporating calibrating quartz 100 kc/s  $\pm 5 \times 10^{-6}$  120/220 v. A.C. mains. £85. Carriage £2.

**PHASE MONITOR ME-63/U.** Manufactured recently by Control Electronics Inc. Measures directly and displays on a panel meter the phase angle between two applied audio frequency signals within the range from 20-20,000 c.p.s. to an accuracy of  $\pm 1.0$ . Input signals can be sinusoidal or non-sinusoidal between 2 and 30 v. peak. In excellent condition together with hand-book and necessary connector. £45. Carriage 30/-.

**AIRMEC FREQUENCY STANDARD METER TYPE 761.** 10c, 100c, 10kc, 100kc, 1Mc. £80. Carriage 30/-.

**COSSOR OSCILLOSCOPE TYPE 1049.** £45. Carriage 30/-.

**MINIATURE PLUG-IN MOVING COIL RELAYS.** Windings: 110 ohm .2mA and 47 ohms .45mA. Works like a moving coil meter, deflection of the coil causing the make and brake of the relay contacts. Ultra sensitive, ideal for transistor circuits, etc. The different energising currents enable two separate functions to be carried out by the one relay. Complete with base 13/6. Post and Packing 2/-.

**BOONTON "Q" METER TYPE 160A.** Frequency range 50 kc/s to 50 mc/s. "Q" range 0-250 with multiplier of 2.5. Main tuning capacitor 30-500pF with separate  $\pm 3$ pF interpolating capacitor. Power supply 220/250vAC. £75. Carriage 30/-.

**AVO VALVE TESTER MODEL 3.** Measurement of mutual conductance 0-100mA/V in four ranges. Screen 0-300v., panelled 0-400v., grid 0/100v., Filament 0/126v., Insulation 0/10m ohms. Rectifying valves and signal diodes can be tested under load conditions, short circuiting of electrodes and cathode insulation can also be measured. Complete with data book for £45. Carriage 30/-.

**SOLARTRON OSCILLOSCOPE TYPE CD 643.2.** Laboratory type. Screen diameter 5in., Band width DC12 mc/s, Rise time approx. 30mu sec. Sensitivity approx. 100 mv/cm—65 v/cm with X1, X10, X100 multiplication and fine expansion control. Controlled bright-up. Z modulation. £130. Carriage 40/-.

**MUIRHEAD - WIGAN DECADE OSCILLATOR D650B.** Frequency 1-111, 100 c/s in two ranges continuously variable above 2 c/s. Accuracy  $\pm 0.2\%$  or 0.5% or 0.5 c/s whichever is greater. Hourly stability  $\pm 0.02\%$  Maximum output 2w into 6,000/8,000 ohms (110/120v.) above 20 c/s. 50 mW into 6,000/8,000 ohms below 20 c/s. £55. Carriage 30/-.

**AIRMAC TYPE 726 AUDIO FREQUENCY METERS.** A very accurate, compact instrument for measuring and checking audio frequencies which are read off directly on a 100μA 6in. meter in the range 0-20 kc/s in three ranges. A built-in oscillator enables the instrument to be calibrated when the accuracy is then 1% of FSD. The instrument may be used as a conjunction with photocell equipment for measuring the speed of rotation apparatus. £30. Carriage 30/-.

**TEST SET RADIO CTS-3/PRC.** Portable test set for complete measurement of performance of FM transmitters and Receivers measuring battery voltages on and off load, IF limiter, alignments AFC, transmitters and RF output. Can be adapted for use with transmitters other than the one for which this set was originally designed. Brand new including connecting cables and spare valves. £6/10/-. Carriage 7/6.

**P. C. RADIO LTD.**  
170 GOLDHAWK ROAD, W.12  
SHEPHERD'S BUSH 4946





# WEYRAD

## COILS AND I.F. TRANSFORMERS IN LARGE-SCALE PRODUCTION FOR RECEIVER MANUFACTURERS

- P.9 SERIES** 10 mm.×10 mm.×14 mm. Ferrite cores 6 mm. 472 kc/s operation. Single-tuned I.F.s and Oscillator Coils.
- P.55 SERIES** 12 mm.×12 mm.×20 mm. Ferrite cores 4 mm. 472 kc/s operation. Single-tuned I.F.s and Oscillator Coils.
- T.41 SERIES** 25 mm.×12 mm.×20 mm. Ferrite cores 4 mm. 472 kc/s operation. Double-tuned 1st and 2nd I.F.s and Single-tuned 3rd I.F. complete with diode and by-pass capacitor.

These ranges are available to manufacturers in versions suitable for most of the popular types of Transistors. The Oscillator coils can be modified to enable specific tuning capacitors to be used provided that bulk quantities are required.

**OUR WINDING CAPACITY NOW EXCEEDS  
50,000 ITEMS PER WEEK**

On the most up-to-date and efficient machines backed by a skilled assembly labour force for all types of coils and assemblies.

**WEYRAD (ELECTRONICS) LIMITED, SCHOOL ST., WEYMOUTH, DORSET**

WW-126 FOR FURTHER DETAILS

## TRANSFORMERS

## COILS

LARGE OR SMALL QUANTITIES

## CHOKES

TRADE ENQUIRIES WELCOMED

SPECIALISTS IN

## FINE WIRE WINDINGS

MINIATURE TRANSFORMERS  
RELAY AND INSTRUMENT COILS, ETC.  
VACUUM IMPREGNATION TO APPROVED STANDARDS

## ELECTRO-WINDS LTD.

CONTRACTORS TO G.P.O., A.W.R.E., L.E.B., B.B.C., ETC.

123 PARCHMORE ROAD, THORNTON HEATH, SURREY  
01.653.2261 CR4.8LZ EST. 1933

WW-127 FOR FURTHER DETAILS

## NEW 48" FOLDING MACHINES SHEET METAL BENCH MODEL BY PARKER

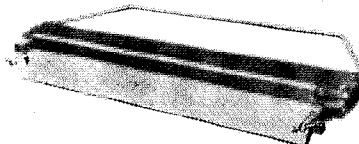

Forms channels and angles down to 45 degrees which can be flattened to give safe edge. Depth of fold according to height of bench.

48" × 18 gauge capacity	£40 0 0	One year's guarantee.
36" × 18 gauge capacity	£25 0 0	Money back if not satisfied.
24" × 16 gauge capacity	£24 0 0	

Carriage Free

Also the well-known vice models of		
36" × 18 gauge capacity	£12 10 0	
24" × 18 gauge capacity	£7 5 0	
18" × 16 gauge capacity	£7 5 0	

Carriage Free

Send for details:

**A. B. PARKER**

FOLDING MACHINE WORKS,  
UPPER GEORGE STREET,  
HECKMONDWIKE, YORKS.

Telephone: 3997

WW-128 FOR FURTHER DETAILS

## HEAT LIGHT SPEED CONTROL Unit

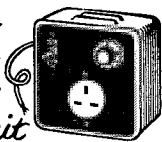

**MK. V 3000 WATT MODEL.** Finger tip control of all A.C./D.C. electrical equipment and units. Suitable for all types of lighting arrangements. Incandescent lamps, spot lamps, arc lamps, floodlights. Makes an excellent dimming unit. Ideal for controlling all electric heaters. Electric blankets and all types of Electric irons. Will control the speed of all drills for all applications. Also lathes and power tools. Contains the latest electronic switching devices and associated thyristorised circuitry. Size 6in. × 5in. × 2in. Louvered metal case in hammer finish. Attractive front panel with matching sockets and controls. Can

be used as an extension box. Ample cable provided. Additional cable if required, 3/6 per yard. The recommended price of these units is 25 gns. Due to a scoop purchase we can offer them at only £9/10/-. Carriage 10/-. C.O.D. 3/6 extra.

## COLLAPSIBLE AERIAL A IN 5 SECTIONS CLOSED 13" OPEN 5'-6"



fully adjustable highly efficient whip aerial. Made to exacting specifications. Copper plated sections. Brass base. An ideal aerial for TX/RX use. Easily adaptable for cars, scooters, walkie talkies etc. Brand new in maker's boxes. Only £1 each, post and packing 2/6. Two aerials for 35/-. post free.

## COMMUNICATION RECEIVER TYPE T.R.G.D.X./20.C.

Brand new fully transistorised Communications Receiver. Specifications: 4. complete ranges 550 Kc/s. to 30 Mc/s., covering all amateur bands, shipping and trawler bands, and broadcast bands. A highly efficient double tuned super-het comprising R/F aerial tuning section, A.V.C. and built-in B.F.O. for C.W. or SSB reception. Operates from 9 volt battery provided that fits internally. Output wattage 3 watts. Ideal for fixed or mobile reception. With speaker and headphone output. Hammer finished robust steel case of pleasing modern design. Size approx. 9 × 7 × 6in. British manufacture. Due to huge purchase we can offer these excellent receivers at less than half their normal price. Complete with handbook. Now modified for improved performance. Price £16/10/-. carr. 15/-. Headphones if required 15/- extra, p.p. 3/6. FREE, FREE. First orders received up to ten days after publication date of this advertisement will receive free a wonderful battery elimi-

nator enabling you to run this receiver and most transistor radios direct from the mains.

**AERIAL TUNER UNITS.** Ideal for TX/RX use. Will load almost anything. Calibrated control dial. Housed in compact steel case. Ideal for all radio amateurs and S.W.L.s. 25/-. p.p. 7/6.

**TWO-WAY TALKIE PHONES.** Ideal for indoor/outdoor use. Will work up to long distances. Can be held in the hand. Clear reception. No G.P.O. licence required. One complete set, £2/10/-, carriage 10/-. batteries 7/6. Special Offer—Two complete sets with batteries £6. inc. carriage.

**MULTI PURPOSE. EXTRA HEAVY DUTY 12 V. D.C. ROTARY RELAYS.** With 1 pair heavy duty D.P.D.T. contacts, plus numerous low current contacts. Metal Baseplate. Paxolin terminal block. Ideally suitable for heavy current switching. Suitable for aerial changeover units or in car electrical systems. Price now 7/6 each, carriage 2/6. Four for 25/-, post 2/6.

**GLOBE SCIENTIFIC LTD**  
DEPT W.W.S. 24 CAWOODS YARD,  
MILL STREET, LEEDS, 9.





# CLASSIFIED ADVERTISEMENTS

**DISPLAYED SITUATIONS VACANT AND WANTED:** £6 per single col. inch.  
**LINE advertisements (run-on):** 7/- per line (approx. 7 words), minimum two lines.  
 Where an advertisement includes a box number (count as 2 words) there is an additional charge of 1/-.  
**SERIES DISCOUNT:** 15% is allowed on orders for twelve monthly insertions provided a contract is placed in advance.  
**BOX NUMBERS:** Replies should be addressed to the Box number in the advertisement, c/o Wireless World, Dorset House, Stamford Street, London, S.E.1.  
 No responsibility accepted for errors.

Advertisements accepted up to JUNE 7 for the JULY issue, subject to space being available.

## SITUATIONS VACANT

**EXPERIENCED** cinema sound engineer required for service and installation, good salary and conditions.—Box WW2022, Wireless World.

**GRAMPIAN REPRODUCERS, Ltd.,** Harworth Trading Estate, Foston, Middx., require senior and junior engineers for development work with audio frequency equipment.—Apply Dept. RB. [223]

**MEN** experienced in industrial electronic equipment testing, or radio and television servicing, are required as testers: West Midlands area.—Box WW2015, Wireless World.

**RADIO** and tape recorder testers and trouble shooters required; canteen, excellent rates of pay, 8 a.m. to 5 p.m., 5-day week.—Elizabethan Electronics, Ltd., Crow Lane, Romford, Essex. Tel. Romford 64101. [1999]

**ELECTRONIC** engineer required for development work on solid state switching devices and quality amplifiers; housing may be arranged for applicants from the G.L.C. area.—Apply Harvey Hall, Thetford, Norfolk. [240]

**A FULL-TIME** technical experienced salesman required for retail sales; write giving details of age, previous experience, salary required to—The Manager, Henry's Radio, Ltd., 303, Edgware Rd., London, W.2. [67]

**WEST** London Aero Club invite "A" and "B" licensed engineers with capital and/or necessary equipment to commence Radio Workshop. Alternative propositions may be considered. Write full details to—White, Waltham Airfield, near Maidenhead, Berks. [68]

**A VACANCY** will arise in September next for an instructor to take charge of the technical preparation of students for the P.M.G. Certificate; applicants must possess a P.M.G. Certificate and a sound knowledge of the Theoretical Subjects: sea-going and/or teaching experience desirable but not essential.—Applications should, in the first instance, be made in writing to Principal, Wireless College, Colwyn Bay, North Wales. [2014]

**INSTALLATION** and Service Engineers, Ekco Electronics require Engineers to install and service Electronic Systems for Hospitals, Airfields and Industrial Establishments. Experience in any of the following fields is desirable, microwave equipments, transistorised pulse circuiting, communication/Navigation equipment, measurement of ionising radiations, electro-mechanical engineering. The base location is at Rochford, Essex, a pleasant district to live. Write to Personnel Manager, Ekco Electronics Ltd., Southend-on-Sea, Essex. [2017]

**ELECTRONICS DEVELOPMENT ENGINEER.** An interesting post has arisen for a man to develop, in collaboration with members of the academic staff, a novel electronic instrument for scientific research. The work will provide ideal experience for a keen electronics developer. The post is tenable for one year in first instance. H.N.C. standard and some development experience is desirable but not essential. Salary up to £1,335 p.a. depending on qualifications and experience. Application forms from Establishment Officer, University College London, Gower St., W.C.1, quoting Chem. 4. [2016]

**EDITORIAL** assistant.—Assistant to the Secretary of Society of Electronic and Radio Technicians required, primarily as an editorial assistant for the Society's Journal; an interest in and an ability for technical writing in the radio and electronics field essential but experience in publishing is not required; the position will also involve committee administration and correspondence; initial salary £1,000-£1,200 p.a.; minimum age 21.—Write, giving details of age, qualifications and experience, to A. J. Kenward, 35, Bedford St., London, W.C.2, marking the envelope "Confidential". [2027]

## SITUATIONS WANTED

**TELEVISION** engineer/contract manager, specialising in closed circuit inspection of pipelines, sewers and underwater structures, desires similar post or development, etc., with go-ahead company.—Box WW2028, "Wireless World."

## BOOKS, INSTRUCTIONS, ETC.

**MANUALS,** circuits of all British ex-W.D. 1939-45 wireless equipment and instruments from original R.E.M.E. instructions, s.a.e. for list, over 70 types.—W. H. Bailey, 167a, Moffat Road, Thornton Heath, Surrey. CR4-8PZ. [66]

## TAPE RECORDING ETC.

**TAPE** to disc transfer, using latest feedback disc cutters; EPs from 21/-; s.a.e. leaflet.—Deroy, High Bank, Hawk St., Carnforth, Lancs. [70]

## SERVICE & REPAIRS

**RADIOGRAMS,** transistors and amplifiers repaired; you send small ones, we handle big ones anywhere in Greater London.—Tel. Hemei Hempstead 3915. Gregg Radio, Ltd., Hemei Hempstead. [245]

**REPAIRS.**—Our modern service department equipped with the latest test equipment including a wow and flutter meter and multiplex stereo signal generator is able to repair Hi Fi and tape recording equipment to manufacturers' standard.—Teleonic Ltd., 92, Tottenham Court Rd., London, W.1. 01-636 8177. [21]

**FOR SALE AND WANTED  
 ADVERTISEMENT FORM  
 TURN TO PAGE No. 129**

## ELECTRONIC ENGINEERS

Service Engineers required for Offices, throughout the United Kingdom, of well-known Company manufacturing Electronic Desk Calculating Machines. Applicants should possess a sound knowledge of basic electronics with experience in electronics, Radar, Radio and TV or similar field. Position is permanent and pensionable. Comprehensive training, on full pay, will be given to successful applicants. Please send full details of experience to

the Service Manager, Sumlock Comptometer Ltd.,  
 102/108 Clerkenwell Road, London, E.C.1.

## THE CIVIL SERVICE

### RADIO AND ELECTRONIC ENGINEERS BOARD OF TRADE (CIVIL AVIATION)

Qualified engineers required as Assistant Signals Officers in the field of Civil Aviation for the provision and installation of advanced electronic equipment—including the latest type of radar, telecommunications, navigational aids, etc.

**QUALIFICATIONS:** Degree with 1st or 2nd class honours in Electrical Engineering or Physics, or have passed all examinations for M.I.E.E., A.M.I.E.R.E. or A.F.R.Ae.S.  
**AGE:** 23 and normally under 35 on 31st December 1968 (extension for Forces and Overseas Civil Service).

**SALARY** (Inner London): On the scale £1,160-£2,092 depending on age and qualifications. Pensionable appointments. Good prospects of promotion.

**APPLICATION FORMS** from Civil Service Commission, Savile Row, London, W.1. X2AA, quoting S/85/ASO.

### Vacancies in the SCIENTIFIC CIVIL SERVICE include: COMMUNICATIONS-ELECTRONIC SECURITY DEPARTMENT, Eastcote, Middx.

**PHYSICISTS** and **ELECTRONIC ENGINEERS** (graded E.O./A.E.O.) to be members of teams engaged on telecommunications research and development. Duties would be allocated where possible to suit the interests and aptitudes of individuals and might include development of communications equipment, exploitation of new techniques such as M.O.S. integrated circuits, designs of digital circuits, conducting and interpreting complex measurements of both audio and radio frequency signals, and the use of computers to aid various research tasks. Relevant experience essential.

**QUALIFICATIONS:** Degree, H.N.C., or equivalent in appropriate subject. Under 22, minimum qualification is G.C.E. in five subjects, including two Scientific/Mathematical subjects at "A" level or equivalent level.

**SALARY** (Outer London): E.O. (minimum age 26) £1,440-£1,809; A.E.O. £659 (at 18)—£878 (at 22)—£1,092 (at 26 or over)—£1,318.

Prospects of permanent pensionable appointments.

**APPLICATION FORMS** from the Recruiting Officer, Communications-Electronic Security Department, 8 Palmer Street, London, S.W.1.

### PROOF AND EXPERIMENTAL ESTABLISHMENT Eskmeals, Bootle Station, Cumberland.

**ELECTRONICS ENGINEER** (graded E.O./A.E.O.) as Instrumentation Officer to assist in the supervision of the Instrumentation Group at Eskmeals, which is responsible for operational and data-processing techniques associated with a missile tracking radar and on-line digital computer system; velocity measurement by doppler radar and optical screen methods; various recording tasks using kinetheodolite, camera, UV and magnetic tape techniques; and timing of a variety of high speed events, e.g. fuse functioning and rocket firings. A knowledge of electronics and previous experience of instrumentation of field trials desirable. Minimum age of A.E.O. is 22.

Unfurnished married accommodation or furnished single accommodation will be available.

**QUALIFICATIONS:** Degree, H.N.C., or equivalent in appropriate subject.

**SALARY:** E.O. (minimum age 26) £1,365-£1,734; A.E.O. £803 (at 22)-£1,017 (at 26 or over)—£1,243.

Prospect of permanent pensionable appointment.

**APPLICATIONS** to Ministry of Defence, CE2(f) (AD), Northumberland House, Northumberland Avenue, London, W.C.2.

# Government of Zambia

## REQUIRES

# TELECOMMUNICATIONS TECHNICIANS

for the General Post Office, on contract for one tour of 36 months in the first instance. Commencing salary according to experience in scale Kwacha 2292 rising to Kwacha 3216 a year (£Stg.1337-£Stg.1876) plus Inducement Allowance of £Stg.506 rising to £Stg.615 a year. Gratuity 25% of total salary drawn. A supplement of £Stg.175/215 a year is also payable direct to an officer's home bank account. Both gratuity and supplement are normally TAX FREE. Free passages. Quarters at low rental. Children's education allowances. Liberal leave on full salary or terminal payment in lieu. Contributory pension scheme available in certain circumstances. Special terms of service apply to serving civil servants including employees of the General Post Office whose applications *must* be sub-

mitted through their own Establishment Division/Head of Department.

Candidates should have had a sound technical education and possess City and Guilds Certificates or equivalent in telecommunications. They should preferably have ten or more years training and practical experience in one or more of the following branches Carrier Systems; HF and VHF Radio; Telegraph Machines; Mixed duties covering these branches.

**Apply to CROWN AGENTS, M. Dept., 4 Millbank, London, S.W.1., for application form and further particulars, stating name, age, brief details of qualifications and experience, and quoting reference M2K/62916/ WF**

# CHALLENGING OPPORTUNITIES in CANADA

Radio and Electronic Technicians with desire to see more of the world can find rich rewards by joining Canadian Marconi Company. Technicians are required for maintenance duties on Northern installations.

Successful applicants will enjoy minimum salaries of \$7,704 plus first-class prospects for rapid advancement and further substantial rises during the first year. There are also genuine opportunities for promotion to supervisory grades with salary ranges of over \$13,500 per annum.

Food and accommodation is provided free for the employee (no family accommodation) in addition to heavy duty clothing. Assistance with air passage is available.

A chance of a lifetime is offered to accrue substantial savings.

**CAN YOU QUALIFY?**

Formal training and experience in maintenance of communications type equipment is required with special emphasis on:

**Microwave**

**Tropospheric Scatter**

**Communications Systems**

**Telephone and Carrier (Multiplex)**

If you have three or more years' experience in installation or maintenance on this type of equipment together with recognized qualifications, i.e. City and Guilds, Higher National, the answer is Yes! Interviews will shortly be held in London and possibly in the provinces. Please send brief career details, quoting WWY 2988F to Mr. D. S. Howell, c/o Directorate of Personnel, English Electric Company Limited, Strand, London, W.C.2.



## CANADIAN MARCONI COMPANY

# Technical Authors

We require qualified and experienced Technical Authors to work on the documentation of a variety of new projects covering a wide range of advanced Avionic Systems including Automatic Flight and Navigation Control systems, digital controlled electronic displays, and associated Test Equipment.

The essential requirement is experience in writing to ATP, ATA specifications and the ability to produce work of a high calibre. Educational requirements up to H.N.C. standard.

Please write or telephone for application form to:—

**The Personnel Manager,  
Elliot Flight Automation Limited,  
Airport Works,  
Rochester, Kent.  
Telephone Medway 44400, Extension 64.**

**ELLIOTT-AUTOMATION**  
AN ENGLISH ELECTRIC COMPANY

## Power Unit Type PP.3911/FLR-9

I/P 120 v. 50 c/s. O/PS +100 v. D.C. at 8 amps., -26 v. D.C. at 4 amps. 7.25 v. A.C. at 78 amps. These are a very elaborate power unit made in 63 by Bogue Elec. for USAF. Both D.C. and A.C. O/P's are stabilised, can be adjusted over limited range and both D.C. circs. employ series type voltage regulators using 15 2N1022 transistors in the 100 v. supply and 5 in the 26 v. supply. Silicon diodes are used in the rectifier circs. The A.C. supply employs a servo driven variac in the pri. circ. of the L.T. trans. This can be adjusted over the range 5.5 to 10 v., all supplies are floating. The D.C. circs. are suitable for feeding valve or transistor circs. and there are 6 separate fused O/P's on each unit; contained in cabinet size 19in. x 28in. x 25in. with 2 pull-out drawers. Supplied in very good condition, tested. Full specifications available on request.

Price: £26, plus 30/- carr.

Auto trans. suitable for running above on 230 v. mains price: £4/10/- (only available with unit).

## Power Unit Type 3614/FLR-9

I/P 120 v. 50 c/s. O/P 10 v. D.C. at 20 amps the O/P is highly stabilised and can be adjusted over the range 9 to 12 v. at 20 amps, ripple at full load less than 10 mil./v. 2 meters are fitted to read O/P volts and current and A.C. and D.C. circ. trips are fitted. The O/P can be adjusted from front panel by means of combined pot and variac, uses series type regulator with 7 2N174 in shunt +4 in control amplifier. Power rect. are silicon diodes. Made in 63 by Bogue Elect for USAF. In good condition and tested.

Price: £16, plus 15/- carr.

## IND. UNIT 1207/FLR-9

This is a digital display unit built into a 19in. rack panel 3 1/2 in. high by 17in. deep. There are three low voltage number tubes plus 1 with special markings. These are mounted side by side on the front panel, giving number 0 to 9. 3 1/2 in. high and work off 6 v. Each number tube has 10 lamps and the size of each tube is 4in. long x 1 1/2 in. high x 1in. wide. Each lamp has 2 transistors to control it 2N404 and 2N1184. These are mounted on plug-in boards, one board to each tube with 20 transistors on a board, i.e. each unit has 4 plug-in boards with a total of 80 transistors. These were made in 63 by Sylvania for USAF. In very good condition.

Price: £8, plus 10/- carr.

Single tubes with transistor board and plugs, price 50/- each, plus 4/6 postage.

## R.F. AMP NO. 4

This is the V.F.O. and P.A. section of the Army No. 53 Tx and covers the freq. range 1.2 to 17.5 Mc/s. in 4 bands, uses valves T111 Osc., T111 Buffer, 807 Driver, and two 813's P.A. 6 x 5 Bias. Rect., VS110 x 2 volt Stab., 3 meters are fitted to Monitor Grid, Anode and Ae. current. Ae. c/o relay is fitted and unit is intended to work into a dipole Ae. Ex. supplies of 1.5 Kv., 400 v., 230 v. A.C. and 12 v. D.C. are required. Unit can be operated with one 813 removed to bring I/P power down to 150 watts. Supplied new and crated with circ.

Price: £15, plus 20/- carr.

## MINIATURE UNISELECTORS

Coil 600 ohm 50 v., contacts 1 pole 11 way 3 bank, made by Clare & Co. U.S.A. ex equipment.

Price: 18/6, plus 3/- post.

## POLARISED RELAYS

They have 2 coils of 1.5K ohm each, contacts 1 pole c/o with dust cover. Both contacts and magnets can be adjusted and moving contact will stay in either position. These can be put to use in the construction of a Scope calibrator and 50 c/s square wave generator, circ. and instructions are supplied, ex-American equipment.

Price: 10/-, plus 1/6 post.

## P.C.R. RX.

These are a 6 valve plus rectifier Long, Med. and S.W. Rx covering S.W. 6 to 18 Mc/s. They have internal speaker socket for phones, tone control, Ae trimmer, slow motion drive. Supplied fitted with 200/250 v. P.U. ready to work. Size front 16in. x 8in. x 10in. deep. Good condition.

Price: £8/10/-, plus 12/6 carr.

SEND FOR FREE LISTS

**B. SLATER, Esq.,  
55 Handsworth Road,  
SHEFFIELD S9 4AA**



# Radio Technicians

required now for vital work in

## Air Traffic Control

Join the National Air Traffic Control Service, a Department of the Board of Trade, and play a vital part in the safety of Civil Aviation. Work on the latest equipment in Computers, Radar and Data Extraction, Automatic Landing Systems and Closed-Circuit Television, at Civil Airports, Air Traffic Control Centres, Radar Stations and other engineering establishments in the South of England, including Heathrow, Gatwick and Stansted.

If you are 19 or over, with practical experience in at least one of the main branches of telecommunications, fill in the coupon now. Your starting salary would be £828 (at 19) to £1,076 (at 25 or over); scale maximum £1,242 (rates are higher at Heathrow). Non-contributory pensions for established staff.

**Career Prospects.** Your prospects are excellent, with opportunities to study for higher qualifications in this expanding field.

Apply today, for full details and application form.

Write for details to: Mr. T. H. Mallett, B.Sc., (Eng.), C.Eng., M.I.E.E., Room 754, The Adelphi, John Adam Street, London, W.C.2, marking your envelope 'Recruitment'.

Name \_\_\_\_\_

Address \_\_\_\_\_

RWW1

Not applicable to residents outside the United Kingdom.

# NATCS

National Air Traffic Control Service

## English Electric Computers

# Field Engineering Division

### Instructors

to teach computer service engineering to trainees. Previous computer engineering and instruction experience would be an advantage. Ref: A

### Installation Planning Engineers

to advise customers on site preparation. Mobility essential and liaison experience useful. Ref: B

### Technical Authors

to prepare technical documentation for maintenance purposes. Ability to write clear, concise English essential. Ref: C

### Commissioning Engineers

to install and commission System 4 machines. Mobility essential and high technical standards are required. Ref: D

### Maintenance Development Engineers

to devise and develop maintenance aids for System 4 machines. Qualified engineers with experience on large scale electronic projects preferred. Ref: E

Vacancies listed above are located at Newcastle, Staffs., but Instructors will also be required in Borehamwood, Herts. and London. Commissioning Engineers are also required in London.

Please write for further details quoting the appropriate reference number to:

Personnel Services (Ref. WW.5548),  
English Electric Computers Limited,  
Field Engineering Division,  
Copthall House, Nelson Place,  
Newcastle, Staffs.

### RESEARCH & DEVELOPMENT

## Electronic Engineers

(£1,300 to £2,000 p.a.)

### THE WORK

needs electronic development engineers for application of latest computing techniques and design of digital and analogue circuits and systems, also for Electro-Optical system, Servo system, Weapon and radar simulation system design and development, and feasibility studies.

### YOUR QUALIFICATIONS

should include a degree or H.N.C. or equivalent, experience coupled with enthusiasm, ability and willingness to take responsibility in the development of new products, and a practical and creative mind.

### YOUR REWARDS

will be a salary and promotion commensurate with ability, a wide range of interesting work, an opportunity to gain exceptional experience, and stability of employment in an expanding company.

### THE COMPANY

designs and manufactures complex flight simulators and electronic teaching aids for world-wide markets and is the largest company of its type in Europe. It is situated in pleasant rural surroundings at Crawley convenient for London and the South Coast. If you are interested in a worth-while career, apply to:

H. C. Hall, Personnel Manager,  
**REDIFON LIMITED**,  
Flight Simulator Division,  
Gatwick Road, Crawley, Sussex.  
Telephone: Crawley 28811



**REDIFON** 

A Member Company of the Rediffusion Organisation



# British Solomon Islands REQUIRE TELECOMMUNICATIONS ENGINEER

for the Posts and Telecommunications Department, on contract for one tour of two years in the first instance. Commencing basic salary in scale equivalent to £ Stg. 1042 rising to £ Stg. 1993 a year, liable to British Solomon Islands Income Tax. In addition an allowance ranging from £ Stg. 716 to £ Stg. 1160, normally TAX FREE, will be paid direct by the British Government to an officer's bank account in the United Kingdom. Gratuity 25% of total salary drawn. Free passages. Terminal payment in lieu of leave. Generous Education Allowances. Contributory pension scheme available in certain circumstances. Candidates should possess the Final City and

Guilds Certificate in Telecommunications and have a good knowledge of the operation and expansion of Strowger telephone exchange equipment. Membership of the Institute of Technician Engineers and broad experience of the installation and maintenance of H F Communications equipment, associated receivers and test equipment in a supervisory capacity will be an advantage.

**Apply to CROWN AGENTS, M. Dept., 4, Millbank, London, S.W.1., for application form and further particulars, stating name, age, brief details of qualifications and experience, and quoting reference M2K/61637/WF**

## Computer Engineering

NCR requires additional ELECTRONIC, ELECTRO-MECHANICAL ENGINEERS and TECHNICIANS to maintain medium to large scale digital computing systems in London and provincial towns.

Training courses will be arranged for successful applicants, 21 years of age and over, who have a good technical background to ONC/HNC level, City and Guilds or radio/radar experience in the Forces.

Starting salary will be in the range of £900/£1150 per annum, plus bonus. Shift allowances are payable, after training, where applicable. Opportunities also exist for Trainees, not less than 19 years of age, with a good standard of education, an aptitude towards and an interest in, mechanics, electronics and computers.

Excellent holiday, pension and sick pay arrangements. Please write for Application Form to Assistant Personnel Officer NCR, 1,000 North Circular Road, London, N.W.2. quoting publication and month of issue.

Plan your future with

**NCR**

## COMMUNICATION ENGINEERS



We are expanding our Broad Band laboratories again because of the world-wide success of our new range of Solid State U.H.F. and Microwave equipments. This provides excellent opportunities not only for the specialist but also for ambitious, young engineers with some experience in this field.

*Please apply to:*

**Personnel Manager,  
Pye Telecommunications Ltd., Newmarket Road, Cambridge.  
Phone: Cambridge (OCA3) 61222.**

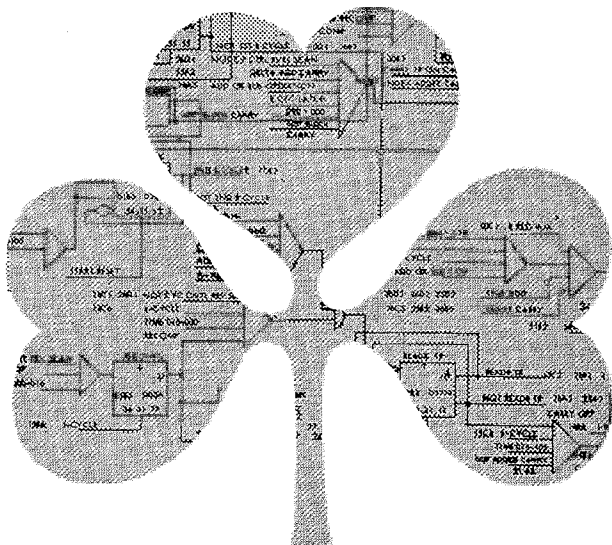

# Engineer: we need your kind of know-how in Ireland.

We are looking for young Irishmen with a knowledge of electro-mechanics to train as Data Processing Customer Engineers – a career which calls for a good deal of ambition and confidence. Is this what you're looking for? Here are the facts:

- As a DPCE you will eventually work on some of the world's most advanced computer systems.
- Your salary will be very good, with plenty of opportunity for promotion to senior posts. It is IBM policy always to promote on merit.
- There are valuable benefits including a non-contributory pension scheme, free life assurance and sickness benefit.
- You will get a really thorough training on modern computers, and this will include opportunities for advanced computer training in Europe or the U.S.A.
- To qualify you need to be between 21 and 27 and have some radio/radar or telecommunications experience. (A radar course with one of the armed forces would be ideal).

In short, this is an exciting opportunity to start on a really go-ahead career in a new environment. IBM Ireland is expanding fast so your chances of promotion in a short time are excellent.

Please write giving details of age, education and experience to: The Personnel Officer, IBM Ireland Limited, 28 Fitzwilliam Place, Dublin 2, quoting ref: DP/WW/033.

# IBM

## LECTURER IN ENGINEERING

### GOVERNMENT OF KENYA

**Qualifications:** Degree in Engineering or Science or City and Guilds Telecommunications Technician's Certificate Final Level, with membership of a recognised professional Institute or an equivalent engineering certificate. Also experience in Television and Sound equipment including Cameras Light Distribution Systems, Video Tape, Telecine and Film equipment.

**Duties:** To lecture to operational and engineering staff up to the standard of the Ordinary Diploma or City and Guilds Final Certificate.

**Terms of Appointment:** Age limit 50 years, on contract for one tour of 24 months. Basic salary scale (taxable) £ Kenya 1,299 to 1,671 (£ Sterling 1,515 to 1,948). Directly paid Inducement Allowance (non-taxable) £ Sterling 848 to 956 which will be paid by British Government direct to officer's bank account outside East Africa. Terminal gratuity 25%. Free family passages, etc.

Candidates, who must be nationals of the United Kingdom or the Republic of Ireland, should apply, quoting RC 237/95/04 giving full names, age, qualifications and experience.

### MINISTRY OF OVERSEAS DEVELOPMENT

Room 301,  
Eland House,  
Stag Place,  
Victoria,  
London, S.W.1

**DAMAGED** instruments, local repairs cheaper; location Midlands; multi meters, insulation testers, leak detectors, moving coil meters, recorders, etc., speedily, expertly repaired; quotations by return; send instrument to: Beeston Instrument Services, Ltd., 7, City Rd., Beeston, Nottingham. Tel. Nottingham 250278. [239]

#### MISCELLANEOUS

**METALWORK**, all types cabinets, chassis, racks, etc., to your own specification, capacity available for small milling and capstan work up to 1in bar. PHILPOT'S METALWORKS, Ltd., Chapman St., Loughborough. [117]

#### ARTICLES FOR SALE

**COLOUR**, Colour TV components, scans, delays, p.c. boards; s.a.e. lists.—Forgestowe, Ketteringham, Wymondham, Nfk. [241]

**FERROGRAPH** record/playback amplifiers, £15; power units for above, £5; extra carr. 12/6.—Bancroft, 71, Leysholme Cres., Leeds, 12. [237]

**SCHOMANDL** frequency meter FD1, with FDML converter, 1KHZ to 900MHZ, in good order; £100 or best offer.—Box WW238, Wireless World.

### COUNTY BOROUGH OF LUTON TELECOMMUNICATIONS TECHNICIAN

Applications are invited for the post of a Telecommunications Technician in the Borough Architect's Department for servicing ground to air equipment at Luton Airport. Applicants experienced in the servicing of Decca 424 Radar, Marconi AD 210C Direction Finder, Mufax facsimile reproduction equipment and I.L.S. equipment and holders of appropriate H.N.C. certificate preferred. The duties will involve shift working.

Commencing salary within Technicians Grades 4/5/6 (£1020—£1665 per annum) according to qualifications and experience. Housing accommodation considered. Reasonable removal expenses paid.

Forms of application may be obtained from the Chief Executive Officer and Town Clerk, Town Hall, Luton, Beds, to whom applications should be submitted as soon as possible.



## ELECTRONIC MAINTENANCE ENGINEERS

Due to expansion, the Installation and Maintenance Division of E.M.I. Electronics Limited has a number of vacancies for Engineers. They will be engaged on the maintenance of a wide range of electronic instruments, closed circuit and broadcast studio television systems, and automation equipment.

Applicants should have had several years' experience of the maintenance of electronic equipment, and these vacancies would appeal to engineers with industrial experience or a services background. Some travelling will be necessary for certain positions.

Excellent commencing salaries and staff benefits.

**EMICAREERS**

Applications giving concise career and personal details to:-

M. WATERS-GROUP PERSONNEL DEPARTMENT  
E.M.I. LIMITED · BLYTH ROAD · HAYES · MIDDX



W.W./6./68.

VACUUM pumps, gauges, etc., recorders, general scientific and laboratory equipment, catalogue.—V. N. Barrett & Co., Ltd., 01-654 6470. [69]

WORLD'S smallest wireless microphones (bugs), rifle bullet size; as sole distributors we offer £5/10, post free.—Box W.W.235, Wireless World.

VACUUM impregnation or casting equipment; 6-gallon, complete with pump, gauges, etc., brand new; £120.—V. N. Barrett & Co., Ltd., 01-654 3972. [2020]

EDDYSTONE 770R V.H.F. receivers, 20mc/s to 165mc/s, overhauled, spec tested, 3-4 years old; £65 ea.—Coal-Salt, Marine Radio Division, Fish Dock Rd., Grimsby. Tel. Grimsby 5346. [2021]

EDDYSTONE EB36, 3 months old, with maker's guarantee, plus joystick and tuner; unwanted Christmas gift, bargain; £53.—Write Stiles, 2, Dalegarth Gardens, Purley, Surrey. [235]

TWO Pye U450L U.H.F. fixed stations, as new; two used condition; Pye Scalamp electrostatic voltmeter, unused; offers.—Box WW2025, Wireless World.

240° taut band 1mA meters, English Electric type 2E, scaled 1-10, unused, boxed, perfect, at trade price; £2/10.—D. Chambers, 13, Kendal Close, Chandlers Ford, Hants. [234]

Graduate or HNC Electronics Engineer to develop circuits for Electronic Instruments.

High and low voltage techniques involved. Bags of scope for enthusiasm and initiative. Experience of Electron Optics an advantage.

Work in our Laboratory in serene rural setting 30 rail minutes from Central London.

Write or Phone.

**JOHN HADLAND (PI) LTD.**

New House Laboratories,  
Bovington, Herts.

Tel: Hemel Hempstead 2303/4/5

## ELECTRONICS INSTRUCTOR

Due to our expanding interests in electronic calculating machines and small computers, we have a vacancy for an additional instructor to join our team based in Central London. After a comprehensive training period, he will assist in the progressive training of service engineers, both from the U.K. and overseas, on the digital techniques used in our equipment. He must also be prepared to carry out training courses abroad at a later date.

The successful applicant will not necessarily have had experience with electronic calculating machines, but he will have a sound knowledge of basic electronic principles and practical experience in electronics, radio, television, radar, or similar fields.

Previous experience as an instructor is not considered to be absolutely essential, but might well be an advantage. We are most anxious to find someone who has the ability and a real desire to teach fellow technicians.

Anyone interested in this vacancy is invited to send full details of his qualifications and relevant experience to Mr. D. D. Davies, Sumlock Comptometer Ltd., The Island, Uxbridge, Middlesex.

## NORTH THAMES GAS

### TECHNICAL ASSISTANTS TO THE COMMUNICATIONS OFFICER

are required in the Building and Property Maintenance Department at Fulham, S.W.6

Two vacancies are in the general field of telecommunications and a wide knowledge of G.P.O. and subscriber-owned private exchanges and equipment is necessary. Candidates must be able to plan, specify and see through to completion P.A.B.X., P.M.B.X. and P.A.X. installations, and private circuit networks for both speech and telemetry.

Applicants should have at least five years general experience and some knowledge of telecommunications traffic is desirable.

The third vacancy is in the general field of radio communication, of which applicants should have at least three years experience.

Knowledge of operation of fixed to mobile, short range hand held, and fixed to fixed for telemetry and data transmission systems on both V.H.F. and U.H.F. is necessary. The ability to analyse and give detailed assessment of circuitry and components and to prepare specifications for complete schemes and to supervise contracts is essential.

Applicants should be prepared to travel throughout the Board's area, and a car allowance will be paid in appropriate cases.

The salary will be within the range £1,295-£1,535 per annum.

Applications stating age, qualifications and experience, should be addressed to:

**Appointments Officer, North Thames Gas,  
30 Kensington Church Street, London, W.8**

quoting reference WW/3820.

## COMMUNICATIONS

# RADIO INSTRUCTORS

Aircraft Systems

## OVERHAUL/MAINTENANCE/OPERATION

If you have thorough experience in the Radio/Radar engineering field you can use your knowledge to advantage as an Instructor in the technical training of ground and flying staff at BOAC's Training Centre.

The Radio/Radar systems used in modern commercial aircraft employ the latest techniques and for these interesting and responsible appointments you must be skilled in one or more of the following areas: Radio Communications (MF to UHF), Radar Systems, Radio/Radar Navigational Aids.

You should preferably also have proved your teaching ability—but if not we are prepared to train you if you can express yourself well.

It would also be an advantage to hold the City & Guilds Final in Telecommunications or HNC (Elect) or better.

The salary range is from £1,592 to £2,008 per annum with additional payment for suitable academic qualifications.

There is an excellent pension scheme together with opportunities holiday air travel.

*If you are interested in a first-class career in training with one of the world's great airlines write at once to:—*

**Manager Selection Services (WW25)**

**BOAC, P.O. Box 10,  
Heathrow Airport - London,  
Hounslow, Middlesex.**



# BOAC

**F**OUND in attic, collector's item or ancient modern display piece, 60 year vintage, commercially made receiver V3A, superb condition, ancillary equip.; best offer over £10.—Box WW236, Wireless World.

**T**INSLEY Drysdale potentiometer with phase-splitting unit type 4337, galvanometer type MS2 1618, £240 the lot; B.P.L. megometer model RM 160/2, £49; all in good condition; send for details.—Box 244, W.W.

**T**RANSISTORS, Siemens BC109Cs for sale, guaranteed to specifications. HFE 240-900, 100OFF 2/- ea., 100OFF 2/6 ea., 10FF 3/- ea.; immediate delivery, c.w.o. 6d., c.o.d. 1/6.—P. Pinnock, 114, Keslake Rd., London, N.W.6. Tel. 01-370-4961. [242]

**F**OR sale, cathode ray tubes; we have 606 tested cathode ray tubes of G.E.C. Mazda, 20th Century and Mullard manufacture; £150 or near offer for the lot, or if desired a detailed list can be obtained from the following: D. W. H. Jackson, 25, Victorian Grove, Stoke Newington, London, N.16. [2022]

**W**ELL-KNOWN units by leading makers! Oscilloscopes for sale at bargain prices: various types from £20 to £195; second-hand but in good condition; a.c. mains operated; 3 1/2 in screens, twin beams, long persistence C.R.T.s on some models; few only—not to be missed.—(Dept. PRM), Lind-Air Optronics, Ltd., 25 & 53, Tottenham Court Rd., W.1. 01-580 1116/7 & 4532 & 7679. [2013]

## WESTREX COMPANY LIMITED

have vacancies for the following skilled personnel:

**ELECTRONICS ENGINEER** conversant with solid state audio amplifier and logic circuit design to co-ordinate development including construction and testing of prototypes.

**TESTER/INSPECTORS** for audio frequency type of work for Q.R. & C. Department.

**ELECTRO MECHANICAL TESTER/INSPECTORS** of teleprinters and high speed tape punches for Q.R. & C. Department. We also require applications of same calibre for field maintenance and installation work; vacancies exist in many major towns.

Please apply in writing stating the vacancy which interests you, giving full details of experience and career to date, to :

**Secretary, Westrex Co., Ltd.,  
152 Coles Green Road,  
London, N.W.2.**

## DAMAGE AND DEFECTS RESEARCH

**SOLID STATE PHYSICS DIVISION,  
ATOMIC ENERGY RESEARCH ESTABLISHMENT,  
HARWELL**

A vacancy exists for an Assistant Experimental or Experimental Officer, who will be required to set up and carry out a wide range of experiments involving both irradiation by high energy particles of samples in order to produce radiation damage and study of damage by electron paramagnetic resonance and also by optical absorption. He will be required to make use of cryogenic techniques and to service and maintain an e.p.r. spectrometer with its associated electronic equipment.

The minimum qualification for the post is five G.C.E. passes including English language at "O" Level and two scientific or mathematical subjects at "A" Level, but preference will be given to those with a degree (or equivalent). In addition candidates should have experience in general experimental techniques involving vacuum apparatus and electronic and optical equipment; experience of electron spin resonance apparatus is desirable but not essential.

Starting salary will be at a point on the scales £625-£1,335 or £1,465-£1,860 depending upon age and experience. The successful candidate may be eligible for Authority Housing or Assisted House Purchase.

Application forms and further details may be obtained from:

**Appointments Section 'A,' A.5240/45,  
A.E.R.E., Harwell, DIDCOT, Berks.**

### SEMICONDUCTORS—SAVE £££'s

Do you spend hours seeking your best buy or that hard-to-find device? COMPLIST shows at a glance comparative prices of all 600 types of semiconductor listed in this issue of WIRELESS WORLD and where to buy them—transistors, diodes, FET, SCR, IC's etc. Send 2/6 (post free) for this month's COMPLIST or £1 for a year's issue. Specimen copy and details free—send 6d. S.A.E. to:—

**COMPLIST (W) P.O. BOX, CHELTENHAM, GLOS.**

### STICK TO YOUR CUSTOMERS!

Self-Adhesive Service Labels with your NAME and PHONE NUMBER

On all your Sales, Servicing, Repairs, etc. Size 2" x 1". Two colour. 3 day delivery. 35/- per 1,000.

Samples: PERMARK (W), Station Grove, Wembley, Middx.

## ASSISTANT ENGINEER

**for CLOSED  
CIRCUIT TELEVISION**

Assistant engineer required to maintain and operate 1" helical scan machines in Recording Centre of rapidly expanding C.C.T.V. Company. Salary to commence at £1,350 p.a. and rising after six months satisfactory service to £1,500 plus pension scheme.

Apply to:

**The Technical Director,  
Television Applications  
Limited,  
9-11 Windmill Street,  
London, W.1.  
Tel: Mus 3521.**

## LECTURER IN WORKSHOP PRACTICE

### GOVERNMENT OF KENYA

**Qualifications:** Ordinary diploma in Mechanical/Electrical Engineering or its equivalent and a minimum of three years' experience teaching use of hand tools, lathes, machinery soldering, etc.

**Duties:** To instruct at engineering and tradesmen's levels all forms of workshop practice.

**Age Limit:** Up to 50 years.

**Terms of Appointment:** On contract for one term of 24 months at salary (subject to local income tax) in the scale £Kenya 1,128-1,440 (£Sterling 1,316-1,680). In addition directly paid Inducement Allowance (non-taxable) £Sterling 800-909 will be paid by British Government direct to officer's bank account outside East Africa. Terminal Gratuity 25%. Free family passages, etc.

Candidates, who must be nationals of the United Kingdom or the Republic of Ireland, should apply quoting RC 237/95/06 and giving full names, age, qualifications and experience, to:—

**MINISTRY OF OVERSEAS  
DEVELOPMENT,**

**Room 301,  
Eland House, Stag Place,  
Victoria, London, S.W.1.**

### REDIFFUSION (EAST MIDLANDS) LIMITED, CASTLE BOULEVARD, NOTTINGHAM.

Senior Equipment Engineers are urgently required to be responsible for the maintenance of high quality sound and vision receiving site equipment; control equipment; high power audio amplifiers; and vision repeater equipment etc. associated with extensive H.F. Wired Vision Networks. Applicants should have a good knowledge of the principles and practice, of the transmission of vision and sound signals along cables; R.T.E.B. or City and Guilds examination qualifications are desirable but not essential. The salaries offered are from £1,100 and upwards depending upon the applicant's age, experience and qualifications and the Company may assist towards removal expenses etc. Please write to the Chief Engineer for application forms.

## ULSTER: THE NEW UNIVERSITY SCHOOL OF HUMANITIES

### LANGUAGE LABORATORY TECHNICIAN

To service, maintain and operate three 12 booth laboratories and associated equipment.

Applicants should have knowledge of solid state circuitry, radio/tape servicing and ability to use frequency test and measuring equipment.

Salary: £722—£1,007 or £987—£1,225

Applications with details of training and experience, and the names and addresses of two referees should reach the Registrar, New University of Ulster, Coleraine, Northern Ireland, by 31st May, 1968.

# REDIFFUSION

## TELEVISION FAULTFINDERS

We have vacancies for experienced television faultfinders in our Production Test Departments. R.T.E.B. Final Certificate or equivalent qualifications or experience are required, a knowledge of transistor circuitry will be an advantage. These positions will be staff appointments with all the expected benefits.

Applications to:

**Works Manager,  
Rediffusion Vision Service Ltd.,  
Fullers Way South,  
Chessington, Surrey (near Ace of Spades).  
Phone: 01-397-5411**

**B**BC.2 television, radio, service, spares. Modify your set BBC.2. New manufacturer's conversion kits and tuners; list available. Pye integrated 405/625 transistorised tuner, £5/5; dual 405/625 IF transistorised panel incl. circuits, £2/15, p/p 4/6; Philips 625 conversion kit incl. tuner, 625 IF panel, switch Assy., 7 valves, circuits, etc., £5/5 (or less valves 50/-), p/p 6/-; GEC/SOBELL 405/625 IF and output chassis incl. circuit, 38/6, p/p 4/6; FERGUSON 625 IF amp chassis incl. 6 valves, 55/- (or less valves 17/6), p/p 4/6; UHF tuners incl. valves, 38/6 (less valves 15/-), p/p 4/6; new VHF tuners, GEC transistorised, 70/-; A.B. Philips dual stand, Brayhead 5003, 50/-; Cydon C. 20/-; KE 16 Mc/s, 33 Mc/s, 10/-, p/p 4/6. Many others available. Fireball tuners, push-button tuners, used, good condition, 30/-, p/p 4/6; TV signal boosters, transistorised Pye/Labgear B1/B3 or UHF battery operated, 75/-; UHF mains operated, 97/6; UHF masthead, 105/-, post free; LOPTS scan coils, frame output transformers, mains croppers, etc., for all popular makes. Salvaged components—large selection of transformers, scan coils, turrets, etc. Enquiries invited. C.O.D. despatch available.—Manor Supplies, 64, Golders Manor Drive, London, N.W.11. Callers 589b, High Ro., North Finchley, N.12 (near Granville Rd.). HIL 9118 (day). SPE. 4032 (evg.). Early closing Thursday 1 p.m. [60]

**V**IDEO and audio tape 1/4in and 1in×2,400ft. huge quantity available at fraction of original cost, please write for details; also 10 1/4in video precision spools for 1/4in or 1in tape, 17/6 and 20/- respectively; Mullard Ferroxcor cores LA1, LA2509, 7/6; LA5, LA6, LA7, 12/6; Plessey vibrators, type 1214, 10/-; Plessey loudspeakers 6in×4in, also 7in×4in, 35 ohms, 15/-; Plessey ganged potentiometers 20K-20K Linear, 7/6; valves N78 10/-, EM84 5/-; Hivac mains neons (built-in resistor) with 6in length twin lead, ideal for electronic gadgets and novelties, new reduced, price 1/3 each or 12/6 dozen (also available 110V); transistors, Mullard OC205 5/-, R.C.A. 2N410 2/6, CV2589 (OC71) 2/-; miniature germanium diodes, new and tested, 100 for 10/-; electrolytic capacitors, 125 MFD, 500V 4in×1 1/2, 9/-, 1000 MFD, 50V 2in×1 1/2, 7/6, 50+50+50 MFD, 350V 3in×1 1/2, 8/-; Enquiries invited for all electrolytics, very wide selection, discount on quantities. Introducing a new rotary wafer switch which is fitted with sprung nylon locator, 1 pole-12 way, 3 pole-4 way, 4 pole-3 way, 2 pole-6 way, etc., 3/6 each, or 36/- dozen. Try us for all "hard to get" spare parts; our prices are reasonable, our service is good and we are world-wide exporters and overseas agents, etc. Please let us know your immediate requirements; lists available.—Elekon Enterprises, 34, Baker St., London, W.1. 01-486 5355. [245]

## AIR FORCE DEPARTMENT

ARE YOU:

\* **INTERESTED IN DOING VITAL WORK ON R.A.F. RADAR AND WIRELESS EQUIPMENT?**

\* Aged 19 and over and of good educational standard (G.C.E. "O" level passes in English language, Maths and Physics. City and Guilds Telecommunications Technicians Certificate or equivalent qualifications are desirable though not essential).

\* Experienced in radio/radar servicing.

### IF SO, WE OFFER:

\* A first class opening as a Civilian Radio Technician. Present salary starting at up to £1,076 p.a. (according to age) and rising to £1,242, and good prospects of promotion (top posts in excess of £2,000 p.a.).

\* Five-day week. Three weeks 3 days annual leave at the start rising to 6 weeks, plus public holidays.

\* Excellent prospects of a good pension. If you do not qualify for a pension then you receive a gratuity if you leave after at least 5 years service. Vacancies exist at R.A.F. Sealand, near Chester, but also arise from time to time at other R.A.F. Stations throughout the country.

Applicants should apply for further information and trade test to:—

**MINISTRY OF DEFENCE (CE3h(Air))  
SENTINEL HOUSE,  
SOUTHAMPTON ROW,  
LONDON, W.C.1**

or call at No. 30 MU Sealand between the following times:—

Monday-Friday 8.30 a.m. to 4 p.m.  
Saturday 8.30 a.m. to 12.30 p.m.

# MICROWAVE SYSTEMS TEST ENGINEERS

Pye Telecommunications Ltd. require at their factory at Haverhill, Suffolk, an Engineer to take charge of an expanding systems engineering team. There are also vacancies for Senior Engineers to become members of this team for work on production test of Broad Band Solid State Link equipment.

Experience of video and/or multi-channel telephony is desirable, preferably with knowledge of semi-conductor work. Preference will be given to applicants holding a good academic qualification.

Attractive salaries will be offered and some assistance with housing in this expanding town may be possible.

All applications will be treated in the strictest confidence.



Apply in writing giving details to:  
The Works Manager

**PYE TELECOMMUNICATIONS LTD.**

Colne Valley Road, Haverhill, Suffolk.

## SCIENCE RESEARCH COUNCIL RADIO & SPACE RESEARCH STATION DITTON PARK, SLOUGH, BUCKS.

Experimental Officers/Assistant Experimental Officers are required to assist in work on the propagation of radio waves through the lower atmosphere. Duties will include the design and development of apparatus, its use in carrying out experiments and the analysis of the results obtained. Successful applicants may be required to work either on experiments using an 82 foot steerable aerial for studying VHF and UHF propagation or on the propagation of millimetre and sub-millimetre waves.

### Qualifications:

University or C.N.A.A. degree, H.N.C. or equivalent qualification. If under age 22, five G.C.E. passes including two science or mathematical subjects at "A" level (or equivalent).

### Salaries

A.E.O. between £584 and £1,243.

E.O. between £1,365 and £1,734.

Send for details to:—

**The Secretary, S.R.C. Radio and Space Research Station, Ditton Park, Slough, Bucks.**

## Radiomobile

BRITAIN'S CAR RADIO SPECIALISTS

have a vacancy for a fully experienced

# SERVICE ENGINEER

The successful applicant will be employed in our Main Service Workshop repairing:—

Transistorised & Valve operated Car Radios,  
Car Tape Recorders,  
Coach Radio & P.A. Equipment,

and also in our Service Garage on installation work and the servicing of equipment already fitted to vehicles.

After gaining considerable knowledge of our products, duties, in the future, may be extended to include mobile Field Service work.

This position carries a good commencing salary together with above average fringe benefits.

Applications should be made in writing to:

The Personnel Manager,  
**RADIOMOBILE LIMITED,**  
Goodwood Works,  
North Circular Road,  
London, N.W.2. GLA 0171

A subsidiary of SMITHS INDUSTRIES LTD.



**CAMBRIDGE WORKS LIMITED**

Haig Road

**JUNIOR ELECTRONIC ENGINEER** required to join a small team developing test instruments for telecommunications. Previous experience of circuit design desirable, together with some mechanical skill. Staff appointment. 37½ hour week. Age 21-25.

Please apply to the  
**Personnel Manager** in writing or by  
telephone, **Cambridge 51351, Ext 327.**

## MINISTRY OF TECHNOLOGY CAREER OPPORTUNITIES FOR GRADE I CRAFTSMEN

Opportunities exist for Craftsmen in the Inspection Division on work involving inspection of electronic equipment.

PAY for Grade I Craftsmen is £20.18.0 (London), £20.5.0 (Provincial) for a 40-hour, 5-day week.

PROSPECTS: Promotion to higher grade posts with salaries up to £2352 for men who possess or obtain the necessary qualifications e.g. O.N.C.

QUALIFICATIONS: A recognised apprenticeship or equivalent experience and training.

HOLIDAYS: 2 weeks (80 hours) rising to 3 weeks (120 hours) after 5 years' service in the grade, plus 8½ days' public and privilege holidays.

Applications, giving brief details of apprenticeship and/or experience, should be sent to:

**Industrial Personnel Officer, Ministry of Technology, Room 217, Baynards House, 1-13 Chepstow Place, London W.2.**

Inner London Education Authority  
**Norwood Technical College**  
Telecommunication & Electronics  
Department

Required for September for duties in the  
Department of Telecommunication and Electronics:

**2 SENIOR LECTURERS**  
**2 LECTURERS GRADE II**  
**1 LECTURER GRADE I**

Applicants, who would be concerned mainly with the work of the full-time Diploma and Certificate Courses, should have good general academic qualifications in Radio and Electronic Engineering and allied subjects. Recent high-level teaching and/or appropriate industrial experience is expected, particularly for the Senior Lecturer and Lecturer Grade II positions. Additionally, specialist knowledge of, and familiarity with, modern techniques in, for instance, Computer Engineering, Microwave and U.H.F. techniques, Radio Transmission and Reception, Television Broadcasting, Radar and Radio Navigational Aids, would be an advantage. Participation in research and development projects is encouraged.

Assistance towards removal expenses may be given.

Salary Scales:

Senior Lecturer: £2,280-£2,595.  
Lecturer Grade II: £1,725-£2,280.  
Lecturer Grade I: £1,035-£1,735, with additions for qualifications; starting point depends on qualifications, training and experience.

The London Allowance of £70 should be added to all the above scales.

Application forms, returnable within 14 days of the appearance of this advertisement, are obtainable from the College Secretary.

**ENGINEERS** Have you considered a career in Technical Authorship? If you have sound experience in electronics or communications and ability to write clear concise English we would train applicants as Technical Authors. The commencing salaries range from £1,300 to £1,700 depending on experience with the prospects of high future rewards and earnings.  
**Box No. 5039, c/o Wireless World**

**SENIOR STATION ENGINEER**  
Education Department  
Government of Hong Kong

**Duties:** To advise on the detailed planning of the engineering requirements of the Hong Kong Government Television Studio complex, and to Supervise the day to day organisation of the Service and co-ordinate the transmitting of the television programmes. In addition to liaise and advise on the installation of equipment and to train technical operations Staff and a local successor to take over the duties of the post.

**Qualifications:** Preferably under 45 years with either (a) B.Sc. (electrical engineering) or equivalent degree or (b) A.M.I.E.E. or (c) H.N.C. At least 10 years post qualification experience covering technical design, development and organisation operation and maintenance of a television broadcast complex and the operation and maintenance of videotape recording equipment and studio cameras (preferably Pilumbicon).

**Terms of Appointment:** On contract for three years. Salary scale, \$4,580 per month rising by annual increments of \$140 per month to \$5,000 per month (£3,778, £3,894, £4,009, £4,125 p.a.), subject to local income tax. Terminal gratuity 17% free family passages, generous leave and education allowance.

Candidates should apply quoting RC 237/81/01 giving full names, age, qualifications and experience to:—

The Appointments Officer,  
MINISTRY OF OVERSEAS DEVELOPMENT,  
Room 301, Eland House,  
Stag Place, Victoria,  
London, S.W.1.

# ULTRA ELECTRONICS LTD.,

Urgently Require

## TEST ENGINEERS

must be experienced in the testing and fault finding of complex electronic equipment.

## PROTOTYPE WIREMEN

Applicants must be able to work from circuit diagrams and verbal instructions.

Both vacancies offer a high rate of pay, good conditions, canteen social and sports club.

Write or phone:—

Personnel Officer, Ref. WW1,  
Ultra Electronics Ltd.,  
Western Avenue,  
Acton,  
London W.3  
Telephone: 01-992 3434.



## MARCONI INSTRUMENTS LIMITED

# ELECTRONIC TECHNICIAN ENGINEERS

are required to fill a number of vacancies at our Works in St. Albans and in Luton. The work is varied and will enable technicians with experience of r.f. circuits to broaden their knowledge of the latest techniques employed in the electronics and telecommunications industries by bringing them into contact with a wide range of the most advanced measuring instruments embracing all frequencies up to U.H.F.

The work involves calibration, testing and fault-finding on telecommunications measuring instruments.

Entrants may be graded as Testers, Test Technicians or Senior Testers according to experience and qualifications. Our expanding production programme geared to our recognised export achievement provides security of employment combined with good prospects of advancement not only within these grades but into other technical and supervisory posts within the Company.

Salaries are attractive and conditions excellent. The Company Pension Scheme includes substantial life assurance cover provided by the Company. Assistance with re-location may also be given in appropriate cases.

Please apply in writing to:

The Personnel Manager,  
Marconi Instruments Limited,  
c/o Directorate of Personnel (WW2890G),  
English Electric House,  
Strand, London, W.C.2.



An English Electric Company

## ELECTRONIC INSTRUMENT TECHNICIAN

We require a technician for the Instrument Section of our Engineering Group. Duties will include the design, construction and maintenance of specialised instruments for pilot scale food processing plant and our research laboratories. Location is Colworth House, near Bedford, which is a large food research centre supporting Unilever's food industries. Candidates should have HNC or equivalent. Starting salary will be determined by experience. The Company has a Superannuation Scheme which includes life insurance. We offer generous help towards relocation expenses for married men including removal expenses, legal and survey fees and help in obtaining house purchase loans.

Please write for an application form to the Assistant Staff Officer, UNILEVER RESEARCH LABORATORY, Colworth House, Sharnbrook, Bedford.



## TELECOMMUNICATIONS

We have vacancies for Fault Finders, Testers, and Inspectors to work on interesting and advanced equipment including H.F. SINGLE SIDEBAND, V.H.F. RADIO TELEPHONES, U.H.F. MINIATURE EQUIPMENT.

Transistor experience is essential. Vacancies exist at all levels and training will be given where necessary.

Apply: **Personnel Manager, CAMBRIDGE WORKS LTD., Haig Road, Cambridge.**

## CITY OF BIRMINGHAM EDUCATION COMMITTEE

MATTHEW BOULTON TECHNICAL COLLEGE DEPARTMENT OF ENGINEERING, Sherlock Street, Birmingham, 5.

### FULL-TIME COURSE IN RADIO, TELEVISION AND ELECTRONICS

The proposed course is intended for young men who are employed in or are intent on making a career in the Radio/Television/Electronic Industries, particularly in the field of servicing.

The course will be of 9 months' duration, starting in September 1968, and will lead to examinations held by the C.G.L.I. and R.T.E.B.

Further details and application forms may be obtained from the Head of Department. E. L. Russell, Chief Education Officer.

## SCIENCE RESEARCH COUNCIL

### RADIO & SPACE RESEARCH STATION DITTON PARK, SLOUGH, BUCKS

### MALE ASSISTANT EXPERIMENTAL OFFICERS

are required for a three-year tour of duty at Stanley, Falkland Islands, for operating and maintaining advanced apparatus for recording scientific information transmitted by telemetry from satellites (shift work). Married staff live in rent-free accommodation in modern well-furnished bungalows. Furnished bed-sitting rooms are available for single staff.

#### Qualifications:

University or C.N.A.A. degree, H.N.C. or equivalent qualification. If under age 22, five G.C.E. passes including two science or mathematical subjects at 'A' level (or equivalent).

#### Salary:

Salary whilst overseas on scale £690 per annum rising to £1,368; starting salary at age 21 years £869; at age 26 years or over, £1,142. Additional overseas allowances and shift pay.

Apply:—

**The Secretary, S.R.C. Radio and Space Research Station, Ditton Park, Slough, Bucks.**

**R**ADIO-MIKES (Lustraphone). 2 units hardly used. 7.1st £155 each, accept £60 each, a genuine offer.—Thornton's Electronics, Ltd., 18-19, Freeman St., Birmingham, 5. Tel. Midland 5588. [2029]

**B**OXES of B.A. nuts and bolts, all brand new to all service men, experimenters, etc.; bolts include 2BA, 4BA and 6BA up to 2in long, various heads, mainly brass, approx. 3-400 items per box; our special price 7.6, plus 2/- post and packing.—Wolton's Wireless Stores, 55a, Worcester St., Wolverhampton. [71]

**A** Better deal for cash customers. We do not provide interest free credit but offer a generous discount of 15% for cash. Equipment despatched brand new in sealed cartons on receipt of remittance with order. Agents for all leading makes. Demonstrations, service, guidance.—Write or phone. Callers welcome. Open all day Saturday, Thursday half day.—Audio Services, Ltd., 82, East Barnet Rd., New Barnet, Herts. Tel. Barnet 6605. [20]

### ARTICLES WANTED

**W**ANTED, televisions, tape recorders, radiograms, new valves, transistors, etc.—Stan Willets, 37, High St., West Bromwich, Staffs. Tel. Wes. 0186. [72]

**W**ANTED Eddystone communication receivers.—H.P. Radio Services, Ltd., 51, County Rd., Liverpool, 4. Tel. Aintree 1445. [73]

**W**ANTED, all types of communications receivers and test equipment.—Details to R. T. & I. Electronics, Ltd., Ashville Old Hall, Ashville Rd., London, E.11. Ley. 4986. [63]

### BUSINESS OPPORTUNITIES

**C**ENTRALLY situated in Portsmouth: modern warehouse/distribution centre of approximately 5,000 sq feet plus a workshop of 700 sq feet which is suitable for light industrial use; to let on a long lease at £1,500 per annum exclusive; modern living accommodation is also available if required.—Please apply by letter to the Secretary, 3, Victoria Crescent, Portsmouth. [2012]

# TECHNICIANS

## MINISTRY OF TECHNOLOGY

### Requires Technicians

Are you interested in electrical, electronic, or mechanical engineering? If so, there are excellent opportunities for you in the Ministry of Technology. The work involves the testing of radar, telecommunications apparatus, electrical power and navigation equipment, as well as the calibration of mechanical and electrical measuring devices.

These posts are mainly in the Woolwich, Harefield and Bromley areas, but vacancies also exist in other parts of the home counties and the U.K.

If you have an Ordinary National Certificate or a final City and Guilds Technicians Certificate you may well be the type of person we need.

The starting salary is £1,004 (age 24) rising by annual increments to £1,149 (age 28) and thence on to £1,283 with additional allowances for the London area and good prospects for promotion. There are also a few posts in the salary range £1,283 to £1,490 for well qualified and experienced candidates.

If you are interested, please send a post card to Mr. A. G. Stewart, Ministry of Technology, Aquila, Golf Road, Bromley, requesting an application form.

## REDITUNE

We have vacancies for...

Engineers experienced in the Maintenance and Operation of PROFESSIONAL TAPE RECORDING EQUIPMENT. A thorough knowledge of up-to-date audio techniques is essential. Also vacancy for Instrument Maker/Mechanic.

Salary according to qualifications, age and experience.

Apply: **Chief Engineer, REDITUNE LTD., Cray Avenue, Orpington, Kent.**  
Tel: Orpington 32121



## TEST EQUIPMENT ENGINEERS

Applications are invited from experienced engineers to fill these vacancies which arise in our Industrial Products Group located at NEWHOUSE, Scotland.

As a Test Equipment Engineer you will—

- ★ Develop, commission and install new test equipment.
- ★ Check, calibrate and test simple and complex electrical and mechanical equipment.
- ★ Consult with and advise engineers and production personnel in use of equipment.
- ★ Assist in design of new test equipment and techniques.
- ★ Report and recommend on design and components.

Applicants should preferably be qualified to H.N.C. Standard with 2 years related experience or have had 5 years experience of special purpose production test equipment.

Assistance will be given with housing and removal costs where necessary.

Applications should be made, in writing, to:—

Personnel Manager  
**HONEYWELL CONTROLS LIMITED**  
Newhouse Industrial Estate  
MOTHERWELL, Lanarkshire, Scotland

# Honeywell

## English Electric Computers

### Computer Test Technicians

Continuing expansion of our new factory at Winsford, Cheshire, enables us to offer interesting and varied work to test technicians at all levels. The work involves the testing of electronic devices and the servicing and calibration of test equipment.

If you have related experience in electronics, telecommunications or television, possibly acquired in H.M. Forces, we should like to hear from you.

Please write or telephone for application form:  
Assistant Personnel & Training Manager,  
English Electric Computers (Ref. WW.5181),  
Winsford, Cheshire.  
Tel: Winsford 3456.

## **BBC tv**

### YOUR HOBBY COULD BE YOUR PROFESSION

BBC Television employs many Film Recordists and Assistant Film Recordists in its Film Operations Department.

For young men between eighteen and twenty-eight, who are interested in imaginative, high-quality tape recording and are dedicated enthusiasts in the art of sound recording, there is a comprehensive training scheme which leads to a challenging and worthwhile career. Conditions of employment are generous and congenial and there are opportunities for travel at home and abroad.

For further details and application form, write to Head of Appointments Department, P.O. Box 1AA, London, W.1. (quoting reference 68.G.662.W.W.).





**FABULOUS VALUE**

**TRANSISTORISED STEREO Hi-Fi RECORD PLAYER**

Build your own Hi-Fi Record Player with the Serenade fully transistorised amplifier which comes complete with 2-10" x 6" speakers and the latest BSR 4 Speed Stereo/Mono Record Changer.

Advanced solid state amplifier only 4½" deep, 14 transistors plus 4 diodes, separate Bass and Treble—10 watts total power. Frequency response 30-15,000 c/s.

**EASY TO INSTALL NO TECHNICAL KNOWLEDGE REQUIRED**

**ONLY 26 GNS. + P&P 17/6**

H.P. terms available. Deposit £8:16:6d and 12 monthly payments of 38/5d (Total H.P. £29:17:6d). Send £7:14:0d today.

**FANTASTIC BARGAIN OFFER!**

**"TRANSCONTINENTAL"**

**FULLY TRANSISTORISED STEREOGRAPHIC RADIOGRAM CHASSIS**

Complete with 2-10" x 6" speakers and the latest BSR Mono/Stereo Record Changer—a complete radiogram at half normal price **ONLY**

10 Watts Total output **34½** P&P  
17 Transistors & 10 diodes **2 GNS. 17/6**

**EASILY FITTED NO TECHNICAL KNOWLEDGE NECESSARY**

H.P. available £9:2:6d deposit plus 18 monthly payments of £1:15:9d (Total H.P. £41:6:0).

Send £10.0.0 today

**callers welcome**

**POST THIS COUPON NOW!**

PLEASE SEND ME FREE DETAILS OF YOUR RANGE

Name .....

Address .....

**LEWIS radio** W58

100 CHASE SIDE, SOUTHGATE, LONDON, N.14. TEL: 01-886 3733/9866

WW-129 FOR FURTHER DETAILS

**ADJUSTABLE HOLE & WASHER CUTTERS**

The right tool for trepanning holes 1"-12½" in diameter

Adjustable hole and washer cutters 18% Tungsten High Speed Tool bits

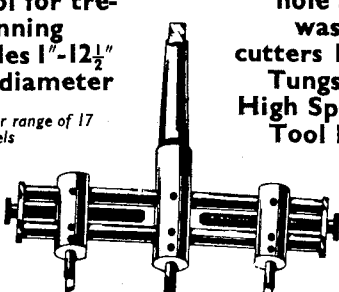

In our range of 17 Models

Write for illustrated brochure of our full range with straight or Morse taper 1-4 or Bitsstock shank.

All models available from stock

**AKURATE ENGINEERING CO. LTD.**  
Cross Lane, Hornsey, London, N.8  
TEL. 01-348 2670

WW-130 FOR FURTHER DETAILS

**RESISTANCE WIRES**

**EUREKA-CONSTANTAN**

Most Gauges Available

**NICKEL-CHROME MANGANIN**

**NICKEL-SILVER**

**COPPER WIRE**

ENAMELLED, TINNED, LITZ, COTTON AND SILK COVERED

SMALL ORDERS PROMPTLY DESPATCHED—  
B.A. SCREWS, NUTS, WASHERS, SOLDERING TAGS, EYELETS and RIVETS

TUFNOL and EBONITE ROD AND TUBES, BAKELITE PANELS, PAXOLIN TYPE TUBES

SEND STAMP FOR LIST. TRADE SUPPLIED

**POST RADIO SUPPLIES**

33 Bourne Gardens, London, E.4  
Telephone 01-254-4688

WW-131 FOR FURTHER DETAILS

**LAWSON BRAND NEW TELEVISION TUBES**

Complete fitting instructions are supplied with every tube.

Terms: C.W.O. Carriage and insurance 10/..

**LAWSON TUBES**

18 CHURCHDOWN ROAD MALVERN, WORCS.  
Tel. MAL 2100

The continually increasing demand for tubes of the very highest performance and reliability is now being met by the new Lawson "Century 99" range of C.R.T.s.

"Century 99" are absolutely brand new tubes throughout manufactured by Britain's largest C.R.T. manufacturers. They are guaranteed to give absolutely superb performance with needle sharp definition screens of the very latest type giving maximum Contrast and Light output; together with high reliability and very long life.

"Century 99" are a complete range of tubes in all sizes for all British sets manufactured 1947-1967.

**2 YEARS FULL REPLACEMENT GUARANTEE**

WW-132 FOR FURTHER DETAILS

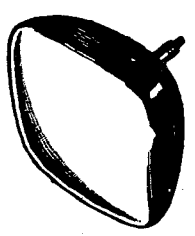

12"—£4 : 10 : 0  
14"—£5 : 10 : 0  
17"—£5 : 19 : 0  
19"—£6 : 19 : 0  
21"—£7 : 15 : 0

**EXCLUSIVE OFFERS**

**LATEST TYPE, HIGHEST QUALITY 7 FOOT HIGH x 24 INCH DEEP TOTALLY ENCLOSED 19 INCH RACK MOUNTING**

**DOUBLE SIDED CABINETS**

having the following unique features

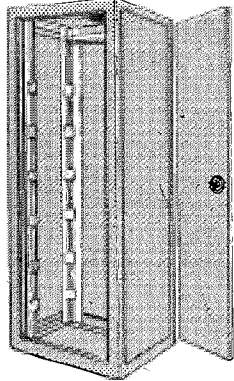

- ★Double sided — the cabinets will take rack panels both sides, that is back and front and they are drilled and tapped all the way down every ½ in. for this purpose.
- ★Fitted "Instant" (World Patent) fully adjustable rack panel mounts both vertically and horizontally — these allow the rack panels to be re-spaced if desired — for instance, if the panels are fitted with projecting components and it is desired to enclose them by doors.

- ★All edges and corners rounded.
  - ★All interior fittings, tropicalised and rust proofed and passivated.
  - ★Built-in Cable Ducts—removable.
  - ★Built-in Blower Ducts—removable.
  - ★Ventilated and insect proofed tops.
  - ★Detachable side panels.
  - ★Full length instantly detachable doors fitted espagnolette bolts available if ordered with cabinets.
  - ★Made in California, U.S.A., cost the American Government £107 before devaluation.
- Finished in grey primer and in new condition.

**OUR PRICE £26 10 0**

(Carriage extra).

(Full length doors £5 each extra).

You do not require doors if you are going to mount panels front and back and do not wish to enclose them.

40-page list of over 1,000 different items in stock available—keep one by you.

★7 Track Teletypewriters	}	£45 0
★7 Track Tape Readers		
★7 Track Tape Punches		
★Kleinichuridi Light weight typing reperfector 5 track		£35 0
★Philco CLR Microwave Multiplex Radiophone		£250 0
★Rectifiers, 3-phase input 28 v. 200 A. out		£35 0
★Siema Teleprinter Monitors		£3 0
★Stelma Logic Units, octal base		£1 10
★Collins 748 H-1 Test Sets		P.U.R.
★Digital Indicators 0-9 v.		£2 0
★Circuit Breakers, 25 amps		10
★Hammarlund SP-600 receivers table model		£85 0
★Uniselectors 10 bank 25 way ex new		£1 15
★Precision Mains Filter Units		10
★Avo Geiger Counters		£7 10
★Illuminated 4 section Switches		£2 0
★Teletype Model 28 Power Supply Units		£5 10
★Teletype Model 28 Function Boxes		£5 0
★Pen Type Personal Dosimeters 0/50R		15
★R.C.A. 420 mc/s 5 el. Yagi Beams		£2 10
★Metro-Vickers Vacuum Pumps 230 v. A.C.		£22 10
★Beekman Helipot 30K and 50K		£1 10
★R.C.A. 25 watt Projector Speakers, range 1 mile		£14 10
★T.200 Panadaptors 450/470 kc/s		£30 0
★Marconi H.R.22 SSB Receivers 2/32 mc/s		£80 0
★Marconi H.R.22 SSB Receivers		£75 0
★AN/UPM-17 Spectrum Analysers 10/18,000 mc/s		P.U.R.
★AN/URM 33, 34, 35 and 36 Signal Generators 1,000/10,000 mc/s		P.U.R.
★Narda 500 w. Ultrasonic Cleaners		£85 0
★Monitor Type 56 and Power Units		£7 10

Carriage extra at cost on all above.

We have a large quantity of "bits and pieces" we cannot list—please send us your requirements, we can probably help—all enquiries answered.

**P. HARRIS**

**ORGANFORD — DORSET**

WESTBOURNE 85051











symbol of quality

trade only

# for electronic components - by return

WW-140 FOR FURTHER DETAILS

## TRAIN TODAY FOR TOMORROW

Start training TODAY for one of the many first-class posts open to technically qualified men in the Radio and Electronics industry. ICS provide specialized training courses in all branches of Radio, Television and Electronics—one of these courses will help YOU to get a higher paid job. Why not fill in the coupon below and find out how?

Courses include:

- RADIO/TV ENG. & SERVICING
- AUDIO FREQUENCY
- CLOSED CIRCUIT TV
- ELECTRONICS—many new courses
- ELECTRONIC MAINTENANCE
- INSTRUMENTATION AND SERVO MECHANISMS
- COMPUTERS
- PRACTICAL RADIO (with kits)
- PROGRAMMED COURSE ON ELECTRONIC FUNDAMENTALS

Guaranteed Coaching for:

- Inst. Electronic & Radio Engs.
- C. & G. Telecom. Techns' Certs.
- C. & G. Electronic Servicing
- R.T.E.B. Radio/T.V. Servicing Cert.
- Radio Amateur's Examination
- P.M.G. Certs. in Radiotelegraphy
- General Certificate of Education

Start today - the ICS way

**INTERNATIONAL  
CORRESPONDENCE SCHOOLS**

Dept. 230 Parkgate Rd., London, S.W.11.

Please send FREE book on

.....  
Name .....

.....  
Address .....

.....  
..... 3.71

WW-141 FOR FURTHER DETAILS

### WANTED—

Redundant or Surplus stocks of Transformer materials (Laminations, C. cores, Copper wire, etc.), Electronic Components (Transistors, Diodes, etc.), P.V.C. Wires and Cables, Bakelite sheet, etc., etc.

Good prices paid

**J. BLACK**

44 Green Lane, Hendon, N.W.4  
Tel. 01-203 1855 and 3033

### CURSONS TRANSISTORS

ALL GUARANTEED

- 1/- each. BAY31, BAY50, DK10. OA70, OA81.  
2/- each. XA101, XA102, OC71, OC72, OC81.  
OC81D, OC44, OC45, GET 16, FST3/1, ACY22.  
3/- each. OC139, OC140, 2N706, 2N708, 2N2894,  
BY100, RAS310AF, 2N914. BSY26. BSY27,  
BSY95A, AFZ12, BFY18, BFY19, BFY26.  
7/6 each. RAS508AF, CRS3/40, BLY10. BLY11,  
BUY10, BUY11. ADY22, ADY23, ADY24, OC26.

### ZENER DIODES

3.9 v. to 26 v., 1/4 w. 3/- each; 1.5 w. 4/-; 7 w. 5/- ea.

**CURSONS,**  
78 BROAD STREET,  
CANTERBURY, KENT  
S.A.E. LATEST NEW LIST

## GODLEYS

SHUDEHILL, MANCHESTER 4

Telephone: BLAckfriars 9432

Agents for Ampex, Akai, Ferrograph, Tandberg, Brenell, B & O, Vortexion, Truvox, Sony, Leak, Quad, Armstrong, Clarke & Smith, Lowther, Fisher, Goodmans, Wharfedale, Garrard, Goldring, Dual, Decca, Record Housing, Fitrobe, G.K.D., etc.  
Any combination of leading amplifiers and speakers demonstrated without the slightest obligation.

WW-142 FOR FURTHER DETAILS

### WE BUY

any type of radio, television, and electronic equipment, components, meters, plugs and sockets, valves, and transistors, cables, electrical appliances, copper wire, screws, nuts, etc. The larger the quantity the better. We pay **Prompt Cash**.

**Broadfields & Mayco Disposals,**  
21 Lodge Lane, London, N.12

RING 445 2713  
445 0749  
958 7624  
958 9842

### PRINTED CIRCUITS

LARGE AND SMALL QUANTITIES.  
FULL DESIGN AND PROTOTYPE  
FACILITIES AT REASONABLE PRICES.  
ASSEMBLY SERVICE ALSO AVAILABLE

**K. J. BENTLEY & PARTNERS,**  
18, GREENACRES ROAD,  
OLDHAM, LANCs.  
Tel. 061-624 0939

WW-143 FOR FURTHER DETAILS

## Quartz Crystal Units

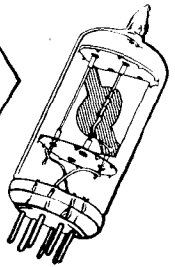

For

**ACCURACY  
RELIABILITY  
PRICE ECONOMY**

you can

**DEPEND  
on**

Write for  
illustrated  
Brochure &  
Price List

**THE QUARTZ CRYSTAL CO. LTD.**

Q.C.C. Works, Wellington Crescent,  
New Malden, Surrey (01-942 0334 & 2988)

WW-144 FOR FURTHER DETAILS

## DEIMOS LTD

**TAPE RECORDERS FOR  
RESEARCH, INDUSTRY AND  
PROFESSIONAL AUDIO**

single and multichannel

8 CORWALL LANE, HILLINGDON, MDX.

HAYes 3561

## LONDON CENTRAL RADIO STORES

10-WAY PRESS-BUTTON INTER-COM TELEPHONES in Bakelite case with junction box handset. Thoroughly overhauled. Guaranteed. £6/10/- per unit.

20-WAY PRESS-BUTTON INTER-COM TELEPHONES in Bakelite case with junction box. Thoroughly overhauled. Guaranteed. £7/15/- per Unit.

MODERN HAND SETS with coiled lead, grey, white and black. £2/6. P.P. 3/-.

TELEPHONE COILED HAND SET LEADS, 3 core, 5/6. P.P. 1/-.

MODERN DESK PHONES, 2 tone grey or black, with internal bell and handset with 0-1 dial. £4/10/- P.P. 7/6.

ELECTRICITY SLOT METERS (1 1/2 in slot) for A.C. mains. Fixed tariff to your requirements. Suitable for hotels, etc. 200/250 v. 10 A. 80/-, 15 A. 90/-, 20 A. 100/- P.P. 7/6. Other amperages available. Reconditioned as new, 2 year's guarantee.

QUARTERLY ELECTRIC CHECK METERS. Reconditioned as new. 200/250 v. 10 A. 42/6; 15 A. 52/6; 20 A. 57/6. Other amperages available. 2 years guarantee. P.P. 5/-.

8-BANK UNISELECTOR SWITCHES. 25 contacts, alternate wiping £2/15/-; 8 bank half wipe £2/15/-; 6 bank half wipe 25 contacts 47/6. P.P. 3/6.

DESK PHONES. Black Bakelite cases, complete with hand set and internal bell with 0-1 dial. 42/6. P.P. 6/-.

HIGH-SPEED ELECTRO-MAGNETIC COUNTERS. Ex-Govt 4 digit. 25/50 v. D.C. Size 4 x 1 x 1 1/2 in. Single coil, 2,300Ω. Single coil 500Ω 8/6. P.P. 3/6.

EX. GOVT. BALANCED ARMATURE THROAT MIKES complete with plug, new, 7/6. P.P. 3/6.

DESK PHONES from 35/- Various types in stock. Final Print Selectors. Relays, various callers, also 19 Receivers in stock. All for callers only.

23 LISLE ST. (GER 2969) LONDON W.C.2

Closed Thursday 1 p.m. Open all day Saturday

## TECHNICAL TRADING Co.

- ★ LONDON—10 Tottenham Court Rd.
- ★ PORTSMOUTH—350-352 Fratton Rd.
- ★ SOUTHAMPTON—72 East St.
- ★ WORTHING—132 Montague St.
- ★ BRIGHTON—Devonian Court, Park Crescent Place

Tel.: MUS 2639  
Tel.: 22034  
Tel.: 25851  
Tel.: 25851

All Mail Order and 24-hour Robophone service Brighton 680722

**BULK!** STEREO DECODERS (Arena 6 transistor complete), 7 Gns.

**BUY!** AM/FM STEREO RADIOGRAM CHASSIS (Normally 26 Gns.), 17 Gns.

**BUY!** AM STEREO RADIOGRAM CHASSIS (Normally 18 Gns.), 11 Gns.

## TRANSISTORISED TUNER CHASSIS

### F.M.

TYPE FMT41 High quality, low noise, battery or mains operation. Reproduction stands comparison with tuners costing 3 times as much. Come and hear it at any of our branches or send to Brighton without delay as we anticipate a very heavy demand. This beautifully compact 6 Transistor machine (size 6in. x 4in. x 2 1/2in.) consists of a low noise frequency changer stage with smooth 2 gang tuning feeding 3 No less than three IF Stages terminating in a double tuned discriminator and LF Stage giving ample output for all quality amplifiers. Operates with negligible drain for months of use from a P.P.3 or any 9 volt battery.

Note: Audio Amplifier of very interesting specification in the course of preparation.

# £8 - 10

POST 2/6





## STELLA NINE RANGE CASES

Manufactured in Black, Grey, Lagoon or Blue Stelvetite and finished in Plastic-coated Steel, Morocco Finish with Aluminium end plates. Rubber feet are attached and there is a removable back plate. There is also a removable front panel in 18 s.w.g. Alloy.

### LIST OF PRICES AND SIZES

which are made to fit Standard Alloy Chassis

Width	Depth	4" Height	6" Height	7 1/2" Height
		£ s d	£ s d	£ s d
6 1/2"	3 3/4"	10 0 0	12 6 6	14 6 6
6 1/2"	4 1/4"	11 6 6	14 6 6	17 9 9
8 1/2"	5 1/4"	12 6 6	16 0 0	17 9 9
8 1/2"	6 1/4"	17 9 9	16 0 0	15 0 0
10 1/2"	6 1/4"	13 0 0	18 0 0	11 9 9
12 1/2"	7 1/4"	17 9 9	17 0 0	14 9 9
12 1/2"	7 1/4"	2 3 3	1 9 9	10 6 6
12 1/2"	8 1/4"	1 8 9	1 4 6	1 8 9
14 1/2"	8 1/4"	1 0 6	1 5 0	1 7 3
14 1/2"	9 1/4"	1 15 0	2 4 9	2 7 0
16 1/2"	9 1/4"	1 11 0	1 17 0	2 1 3
16 1/2"	10 1/4"	1 19 3	2 10 0	2 17 6

Cases—Post 4s. 6d.

### CHASSIS in Aluminium, Standard Sizes with Gusset Plates

Sizes to fit Cases. All 2 1/2" Walls.

	s	d		s	d		s	d
6" x 3"	5	6	10" x 7"	8	6	14" x 3"	7	3
6" x 4"	5	9	12" x 3"	6	9	14" x 9"	14	6
8" x 3"	6	6	12" x 5"	7	6	16" x 6"	10	9
8" x 6"	7	9	12" x 8"	10	9	16" x 10"	16	0

Chassis—Post 3s. 0d.

**CHASSIS.** Made up to your size, 1in., 1 1/2in., or 2 1/2in. walls up to 16in. wide x 10in. deep. 18 s.w.g. half hard aluminium at 7/6 per sq. ft., total area. This price includes gusset corners fitted. Add 3/- postage.

**ALUMINIUM PANELS.** Cut to size 5/- sq. ft., 18 s.w.g. 5/9 16 s.w.g. 6/9 14 s.w.g. Add sufficient post. Surplus refunded or send for postal rates.

## E. R. NICHOLLS

MANUFACTURER OF ELECTRONIC INSTRUMENT CASES

46 LOWFIELD ROAD  
STOCKPORT - CHESHIRE

Tel.: STOCKPORT 2179

## WORLD RADIO & T.V. HANDBOOK

By JOHANSEN

1968 ED. 42/- P. & P. 1/-

The Practical Aerial Handbook, by King, radio and T.V. 35/- P. & P. 1/3.

Silicon Controlled Rectifiers, by Lytel, 21/- P. & P. 1/-.

Circuits for Audio and Tape Recording, by Judd. 7/6 P. & P. 1/-.

Computers for the Amateur Constructor, by Warring, 20/- P. & P. 1/-.

Colour T.V. Pal System, by Pachtett, 40/- P. & P. 1/3.

New Radio Year Book 1968 by Miles Henslow 15/- P. & P. 1/-.

Aerial Handbook, New 2nd Ed., by Briggs, 15/- P. & P. 1/-.

Tape Recording for the Hobbyist, by Zuckerman, 26/- P. & P. 1/-.

Where possible 24-hour service guaranteed

## UNIVERSAL BOOK CO.

12 LITTLE NEWPORT ST., LONDON, W.C.2

(Leicester Square Tube Station)

WW—148 FOR FURTHER DETAILS

## REDUNDANT OR SURPLUS RADIO — ELECTRONIC STOCKS WANTED

### OSMABET LTD.

46 KENILWORTH ROAD, EDGWARE, MIDDX.

TEL: STONEGROVE 9314



### HORSTMANN 20AMP ELECTRIC TIME SWITCH

200/250 volts, 20 amp. contacts.

ON/OFF TWICE every 24 hours at any manually pre-set times, or alternatively with SOLAR DIAL ON at dusk OFF at dawn. By-pass override, 26 hour spring reserve, overcomes stopping in case of power cut. Used but perfect guaranteed. State dial required.

MAKERS PRICE OVER £12 OUR PRICE 69/6 p.p. 4/6

Waterproof metal case approx. 8in. x 3 1/2in. x 3 1/2in. 10/- extra

HORSTMANN 15 DAY CLOCKWORK TIME SWITCH

Jewelled movement. Once ON/OFF every 24 hours at any manually pre-set times. Key and mounting bracket. Used but perfect. 5 amp model. Fully guaranteed. 35/- P. & P. 4/6.

VENNER 200/250 v. FLASHER UNITS containing mains geared motor. ON/OFF every second. 200W 39/6 inc. post costs. Suppressed. Reconditioned.

Box 365, KINGSWOOD SUPPLIES (w.w. 13)  
4, SALE PLACE, LONDON, W.2. Tel: 01-723 8189.



## THE ONLY COMPREHENSIVE RANGE OF RECORD MAINTENANCE EQUIPMENT IN THE WORLD!

Send stamps value 9d. for 16 page booklet and supplementary data sheets Nos. 1 and 4 giving the fullest and latest information.

CECIL E. WATTS LIMITED  
Darby House  
Sunbury-on-Thames, Middx.

WW—149 FOR FURTHER DETAILS

### GENUINE ARTICLES ONLY!

NOT "seconds", NOT "re-marks", but BRAND NEW, PERFECT and GUARANTEED to spec. DISCOUNT prices (in brackets) for 5 OR MORE SAME TYPE.

AD161	7/9 (6/4)	BF224	5/- (4/-)
AD162	7/9 (6/4)	2N706	3/4 (2/7)
AF239	10/- (8/6)	2N2926	3/- (2/6)
BC107	3/11 (3/1)	2N3707	5/- (4/3)
BC109	3/6 (3/-)	2N4058	5/6 (4/7)
BC168	2/6 (2/-)	IS44	1/9 (1/4)
Rectifier IS557	800piv 0.5A	3/6 (3/-)	

CWO. Mail order only. Orders over 10/- U.K. post paid.

AMATRONIX LTD. (Dept WW6),  
396 Selsdon Road, Croydon, Surrey, CR2 0DE

### HIGH GLOSS METALLIC HAMMERED ENAMEL

MAKES FANTASTIC DIFFERENCE TO PANELS

—say hundreds of enthusiastic users.

'Crackle' pattern appears like magic on wood and metal. No undercoat. Air dries 15 MIN. to hard, glossy finish. Heat, liquid & scratch-proof. Lt. & Dk. Blue; Bronze; Silver; Green; Black. Send 10/- NOW for trial 3pt. Tin. Col. samples & instr'ns.

**HAMMERITE** FINNIGAN SPECIALITY,  
PAINTS, Dept. W.,  
STOCKFIELD. Tel. 2280.  
Northumberland.

BRUSH OR SPRAY-ON

WW—150 FOR FURTHER DETAILS

### DAMAGED METER?

Have it repaired by Glaser

Reduce overheads by having your damaged Electrical Measuring Instruments repaired by L. Glaser & Co. Ltd. We specialise in the repair of all types and makes of

### INSTRUMENT REPAIRS

Voltmeters, Ammeters, Microammeters, Multirange Test Meters, Electrical Thermometers, Recording Instruments, Leak Detectors, Temp. Controllers, all types Bridges & Insulation Testers, etc.

As contractors to various Government Departments we are the leading Electrical Instrument Repairers in the Industry. For prompt estimate and speedy delivery send defective instruments by registered post, or write to Dept. W.W.:-

### L. GLASER & CO. LTD.

1-3 Berry Street, London, E.C.1

Tel.: Clerkenwell 5481-2

WW—151 FOR FURTHER DETAILS

## SURPLUS BARGAINS

(EX GOVT)

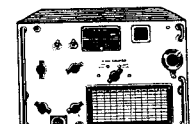

### COLLINS (U.S.A.) RECEIVER.

7 valve superhet (Int. Octal valves). Exceptionally stable for SSB. Frequency coverage 1.5-12 Mc/s. Power required, 250 v. D.C. 80 mA. 12 v. A.C. 1.25A. Excellent condition. £12.

**FAMOUS No. 19 SET TRANS/RECEIVER.**  
Covers 2-8 Mc/s. in 2 bands. 11 valve superhet transceiver including 807 P.A. Power reqs. LT. 12 v. H.T. rec. 275 v. H.T. transmit 500 v. D.C. Slightly used, 55/- Selected condition, 55/- All 19 set ancillary parts available.

**No. 31 TRANSCEIVER VHF.** 40/48 Mc/s. Tunable. 90/60/44 volts battery operation, 70/-

**No. 88. TWO-WAY RADIO.** 40/42 Mc/s. Crystal controlled. 4 channel. 50/- each.

**B44. VHF RADIO TELEPHONE.** 60-95 Mc/s. Crystal controlled. 12 v. D.C. operation. £7/10/-

**No. 62. TRANSMITTER RECEIVER.** 1.6-10 Mc/s. Tunable or crystal controlled. 12 v. D.C. operation. £18/10/-

**R.C.A. C89 TRANSMITTER RECEIVER.** 2-8 Mc/s. Complete station. Brand new. 12 or 24 v. D.C. operation. £19/10/-

**No. 52 RECEIVERS.** Few left. Used (serviceable). £7/10/-

**TUBULAR STEEL TELESCOPIC AERIAL MASTS.** 20ft., 4 section, 70/- 32ft., as above with 12ft. whip, 80/- 34ft., 6 section, 90/-

**MAKE YOUR OWN AERIAL MAST!**  
5ft. 8in., 2in. dia. interlocking steel sections (7 sections make 35ft. mast). 20/- per section.

**NYLON GUY ROPES,** with semi-automatic tensioner. 33ft., 6/6 50ft. 7/6 60ft. 8/-

**ROTARY TRANSFORMERS BY HOOPER.** 12 v. D.C. input. Output 250 v. D.C. at 125 mA., 25/- 12 v. D.C. input, Output 490 v. D.C. at 65 mA., 25/-

**REJECTOR UNIT.** For rejecting unwanted signals. Switched 4 ranges. 1.2-10 Mc/s. 30/-

**R.F. ANTENNA TUNER (A.T.U.).** 160/80/40 metres. 25/-

**MOVING COIL HEADPHONES.** Soft rubber car pads. 15/6

**D.L.R. BALANCED ARMATURE HEADPHONES.** 12/6

**HEADSET WITH BOOM MICROPHONE.** As used with 88 Set. 22/6

**MOVING COIL HEADPHONES AND MICROPHONES.** 21/6

**TRANSMITTER.** 1.75-16 Mc/s. 3 waveband tuneable. 813PA. Complete with all valves, and circuit. £7/10/-

**POWER SUPPLY.** 12 v. D.C. input, 285 and 1300 v. D.C. 300 mA output. Incorporates 240 v. D.C. 80 mA vibrator pack circuit. £7/10/-

**ALL ITEMS CARRIAGE EXTRA**  
Lists giving fuller details of these and many other surplus bargains, 2/- S.A.E. all enquiries (Please print clearly)

**A. J. THOMPSON (Dept. WW)**  
"Eiling Lodge," Codicote, Hitchin, Herts. Tel.: Codicote 242  
Hours of Business: Monday to Friday 8-5 Saturday 8-12  
Prices correct at time of press, but are subject to increase.

## FOR THE BEST

Hi-Fi Equipment  
and  
Tape Recorder

"BITS and PIECES"

## BERRY'S RADIO

25, High Holborn, London, W.C. 1.

(opp. Chancery Lane)

WW—152 FOR FURTHER DETAILS

## WE PURCHASE

PLUGS AND SOCKETS, MOTORS, TRANSISTORS, VALVES AND KLYSTRONS, RESISTORS, CAPACITORS, POTENTIOMETERS, TEST EQUIPMENT, RELAYS TRANSFORMERS, METERS, CABLES, ETC.

PROMPT PAYMENT & COLLECTION  
TURN YOUR CAPITAL INTO CASH

### ELECTRONIC BROKERS LIMITED

8, BROADFIELDS AVENUE, EDGWARE,

MIDDLESEX.

TEL. 01-958 9842



# Get around! with Audac portable V.H.F. receiver unit RX/S

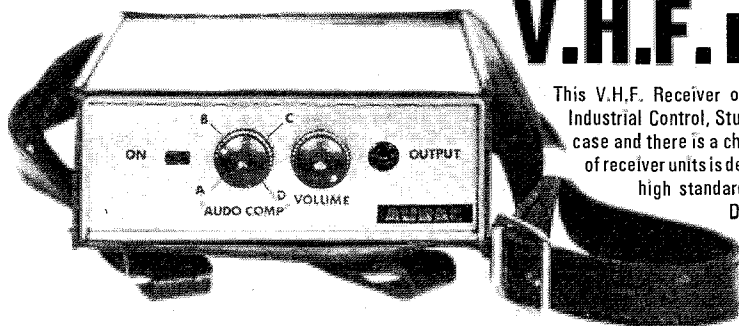

This V.H.F. Receiver offers narrow or wide band operation. Its extreme portability makes it ideal for Industrial Control, Studio talk back and Radio Paging Systems. The unit is fitted into a leather carrying case and there is a choice of telescopic or strap aerial. Size 4" x 1 1/2" x 6" Weight 15 ozs. The whole range of receiver units is designed for use with Audac Radio-Microphone Transmitters and incorporates the same high standards of design and precision engineering to provide long and trouble-free service. Details and literature available on request

**AUDAC RADIO MICROPHONE AND SOUND REINFORCEMENT SYSTEMS**  
 AUDAC MARKETING COMPANY LTD/FOREST WORKS/CAREY RD/  
 WAREHAM/DORSET/Tel: Wareham 2245

WW-154 FOR FURTHER DETAILS

## INDEX TO ADVERTISERS

Appointments Vacant Advertisements appear on pages 107-120

	PAGE		PAGE		PAGE
Acoustical Mfg. Co., Ltd.	2	Hall Electric, Ltd.	10	Parker, A. B.	104
Adcola Products, Ltd.	iii	Harmsworth, Townley & Co.	67	Park Royal Porcelain Co., Ltd.	50
A.D.S. Relays, Ltd.	70	Harris Electronics (London), Ltd.	50	Patrick & Kinnie	123
Adler, B., & Sons	53	Harris, P.	121	P.C. Radio, Ltd.	102, 103
Akurate Eng. Co., Ltd.	121	Hart Electronics	127	Phillips N.V.	8, 9
Amatronic, Ltd.	128	Harverson Surplus Co., Ltd.	84	Pinnacle Electronics, Ltd.	25, 27
Amplivox, Ltd., Industrial Division	4	Hatfield Instruments, Ltd.	56, 60	Plessey Components Australia	53
Angers Electronics, Ltd.	29, 42	Henry's Radio, Ltd.	97	Post Radio Supplies	121
A.N.T.E.X., Ltd.	11	Howell's Radio, Ltd.	54	Proops Bros., Ltd.	83
Andrew Antenna Systems	37	H.P. Radio Services, Ltd.	48	Pye Telecommunications, Ltd.	17
A.P.T. Electronic Industries, Ltd.	59	Hunt, A. H. (Capacitors), Ltd.	43		
Armstrong Audio	38			Quartz Crystal Co., Ltd.	126
Audac, Ltd.	130				
Audio & Design	56			Racal Instruments, Ltd.	31
Audix, B. B.	34			Radford Electronics, Ltd.	79
Avo. Ltd.	1			Radio & T.V. Services, Ltd.	76
Avon Communications & Electronics, Ltd.	60			Radio Components Specialists	129
				Radio Exchange	90
				Radiospares, Ltd.	126
				Raife, P. F.	82
				Rank-Wharfedale, Ltd.	47
				Rastra Electronics, Ltd.	27
				R.C.A.	28
				Readers Radio	105
				Render Instruments	123
				Rola Celestion, Ltd.	49
				R. S. C. (Hi-Fi Centres), Ltd.	98, 99
				R.S.T. Valve Mail Order Co.	125
				Samsons (Electronics), Ltd.	127
				Service Trading Co.	94, 95
				Servo & Electronic Sales	127
				Shure Electronics, Ltd.	16
				Silentbloc, Ltd.	36
				Sinclair Radionics, Ltd.	77
				S.M.E., Ltd.	40
				Smith, C. W. (Radio), Ltd.	86, 87
				Solaris Electronic Group, Ltd.	32
				Superior Electronics Inc.	48
				Sutton Electronics	122
				Swanco	106
				Tape Recording Magazine	129
				Technical Trading Co.	126
				Tequipment, Ltd.	68
				Telford Electronics	122
				Teonex, Ltd.	20
				Thompson, A. J.	128
				Tomura Bussan Kiesha, Ltd.	123
				Trend Electronics, Ltd.	52
				Trio Corporation	24
				T.R.S. Radio	124
				Turner, Ernest, Elec. Insts., Ltd.	65
				T.V. Mini Mart	129
				Universal Book Co.	128
				Valradio, Ltd.	44, 52
				Vero Electronics, Ltd.	40
				Vitality Bulbs, Ltd.	42
				Vortexion, Ltd.	51
				Walker-Spencer Components	125
				Watts, Cecil E., Ltd.	128
				Wayne Kerr, The, Co., Ltd.	39
				Webber, R. A., Ltd.	96
				Welwyn Tool Co., Ltd.	44
				West Hyde Developments, Ltd.	75
				West London Direct Supplies	90
				Weyrad (Electronics), Ltd.	104
				Whiteley Electronic Radio Co., Ltd.	78
				Wilkinson, L. (Croydon), Ltd.	100
				Yukan Products	124
				Z. & I. Aero Services, Ltd.	60, 78, 89

ADCOLA

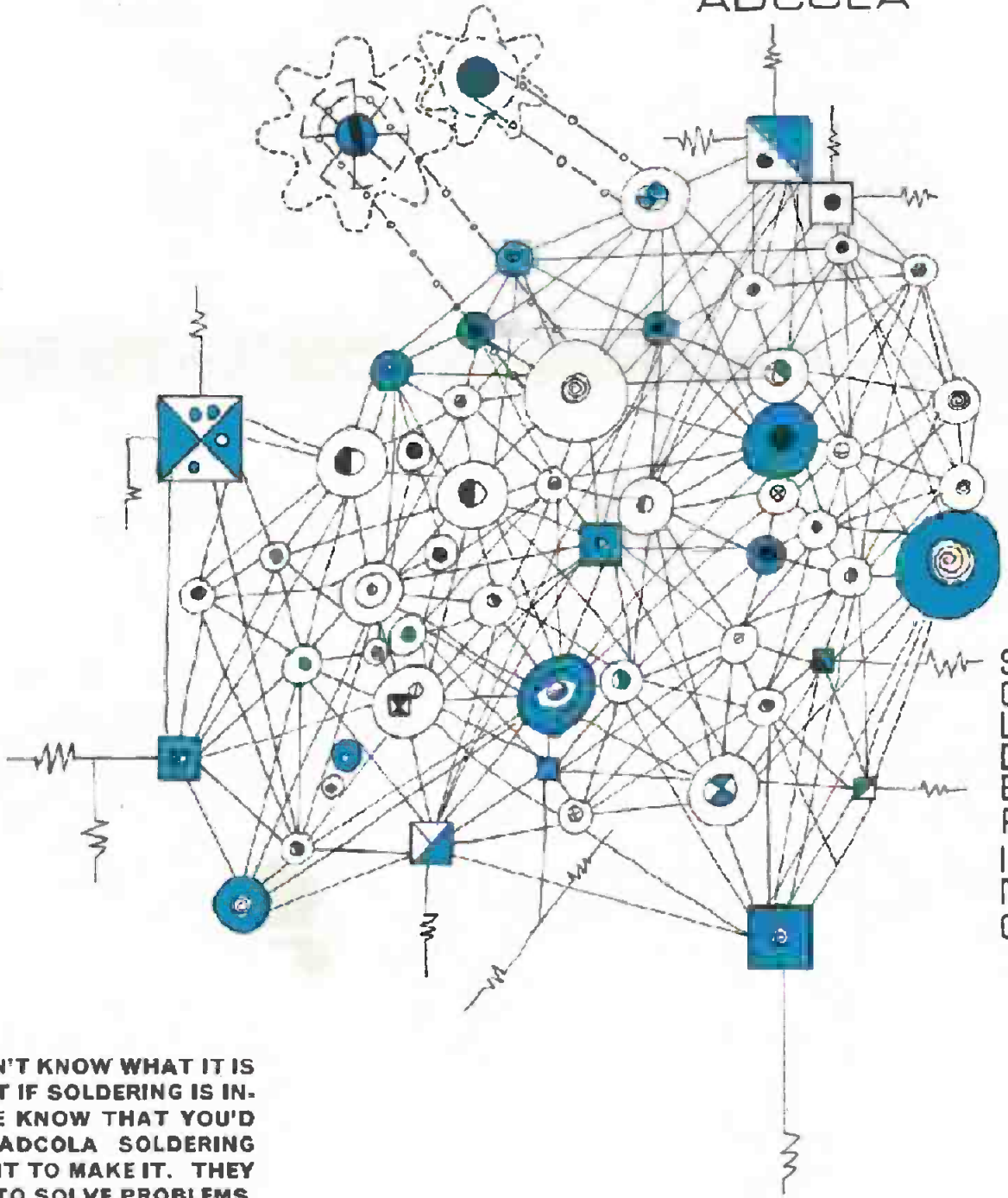

02-DMDF00

00-HZM3CD-10Z

NO, WE DON'T KNOW WHAT IT IS  
 EITHER, BUT IF SOLDERING IS IN-  
 VOLVED WE KNOW THAT YOU'D  
 NEED AN ADCOLA SOLDERING  
 INSTRUMENT TO MAKE IT. THEY  
 ARE MADE TO SOLVE PROBLEMS  
 SEND NOW FOR THE LATEST  
 CATALOGUE.

**ADCOLA**  
 PRODUCTS LIMITED  
 (Regd Trade Mark)

ADCOLA HOUSE, GAUDEN ROAD,  
 LONDON, S.W.4 Tel. 01-622 0291/3  
 Telegrams: SOLJOINT LONDON S.W.4



# In addition to Ersin Multicore 5 Core Solder we make these products to help industry and laboratories

## special products for the soldering of printed circuits

A complete range of products for the soldering of printed circuits, including:

P.C. 2 Dip Cleaner P.C. 10A Activated Surface Preservative  
P.C. 21A Printed Circuit Liquid Flux P.C. 51 Finishing Enamel.  
Solid Solder Wire, Solder Sticks, Solder Ingots and Ersin Multicore  
5-core Solder Wire for direct application to panels.

## Mark 2 solderability test machine

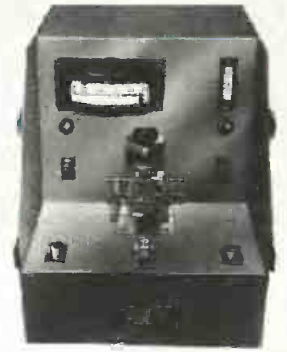

Incorporates many new features, including semi-automatic electrical timing, proportional temperature control, remote controlled specimen lowering system and a temperature meter calibrated to an accuracy of 0-25% full scale deflection at the test temperature. The machine can reduce production costs by instantly checking the solderability of components with wire terminations. It complies with B.S.I. and proposed M. of D. and International Solderability Test Specifications.

## solder tape, rings, preforms, washers, discs, and pellets



Made in a wide range of solid or cored alloys. Tape, rings and pellets are the most economical to use.

## liquid fluxes

7 standard non-corrosive Ersin Liquid Fluxes, all comply with D.T.D. and Mil specifications. Arax Acidic Liquid Flux, the residue is easily removed, is faster than zinc chloride types but much less corrosive. In 1-gallon or 5-gallon non-returnable containers.

## 3a automatic soldering machine

Specially designed for manufacturing processes involving repetitive soldering operations. An exact quantity of Ersin Multicore Solder is



automatically fed at each downward stroke. It can be operated by foot treadle or compressed air system, or may be connected to form part of an automatic assembly sequence.



## Arax 4-core acid cored solder

Used in 38 industries it has replaced tinman's and blowpipe solders, fluid and paste fluxes and killed spirits for rapid and precision soldering in metal fabrication processes.

Arax Flux—exclusive to Multicore—has the fastest speed of flux in any cored solders. Flux residue is easily removable with water or, where flame heating is employed, is entirely volatilized. Residue will not contaminate plating baths. No pre-cleaning is necessary and the speed ensures that the solder will flow between the laps by capillary action, thus using the minimum amount of solder. Not recommended for wire to tag joints in radio or electrical equipment.

## Bib accessories can be supplied in bulk packings at very competitive prices

### wire stripper and cutter

model 8

Strips insulation without nicking wires, cuts wires and cables cleanly. Model 3 is semi-permanently adjusted. Model 8 incorporates a unique 8-gauge selector.



A

### recording tape splicer

model 20



Precision made, chrome plated complete with razor cutter. Provides quick and accurate tape editing. Standard model for  $\frac{1}{2}$ " tape. NEW  $\frac{3}{4}$ " type is available for computer and video tape.

B

### instrument cleaner

Anti-static. Specially formulated for cleaning delicate instrument panels, plastic, chrome, glass and printed surfaces. Antiseptic, non-toxic, non-flammable, does not smear. Used and recommended by leading electronic manufacturers. In 1-gallon and 5-gallon containers and 4 fl. oz. bottles.



C

### tape head maintenance kit size E

Cleans tape heads and all parts of the tape path of magnetic tape decks. Applicator and Polisher Tools and Sticks are available separately.



D

For further information please apply on your Company's note paper mentioning the product references  
Dept. WW, Multicore Solders Limited, Hemel Hempstead, Herts. Telephone: Hemel Hempstead 3636

WW-002 FOR FURTHER DETAILS